

# TM 9-618

**WAR DEPARTMENT TECHNICAL MANUAL**

---

**Generating Unit M7**

*WAR DEPARTMENT TECHNICAL MANUAL*

*TM 9-618*

---

## Generating Unit M7

This Manual supersedes paragraph 84 of TM 9-370, 90-mm  
Antiaircraft gun materiel M1 and M1A1, 31 December 1942.



---

*WAR DEPARTMENT*  
*30 JULY 1943*

9030684

PROPERTY OF U.S. ARMY

WAR DEPARTMENT

WASHINGTON 25, D.C., 30 July 1943

TM 9-618, Generating Unit M7, is published for the information and guidance of all concerned.

[ A.G. 300.7 (30 Jul 43)  
O.O. 461/49023 Rar. Ars. (30 Oct 43) ]

BY ORDER OF THE SECRETARY OF WAR:

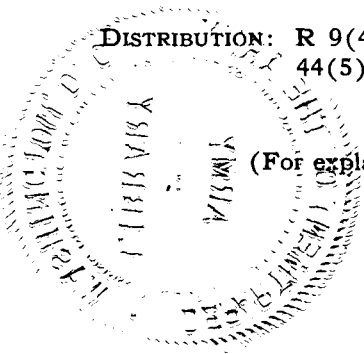
G. C. MARSHALL,  
*Chief of Staff.*

OFFICIAL:

J. A. ULIO,  
*Major General,  
The Adjutant General.*

DISTRIBUTION: R 9(4); Bn and H 44(3); Bn 9(2); C 9(8); IC 44(5).

(For explanation of symbols, see FM 21-6.)



JAN 11 1944  
U. S. Property

\*TM 9-618

# CONTENTS

	Paragraphs	Pages
<b>PART ONE—OPERATING INSTRUCTIONS</b>		
SECTION I. Introduction . . . . .	1- 4	2- 10
II. Operation and controls . . . . .	5- 10	11- 20
III. Inspection . . . . .	11- 16	20- 24
IV. Lubrication . . . . .	17- 20	24- 29
V. Tools and equipment . . . . .	21- 24	29- 31
VI. Operation under unusual condi- tions . . . . .	25- 36	31- 40
 <b>PART TWO—ORGANIZATIONAL MAINTENANCE INSTRUCTIONS</b>		
SECTION VII. Maintenance allocation . . . . .	37- 38	41- 43
VIII. Frame . . . . .	39- 41	44
IX. Engine . . . . .	42- 45	44- 52
X. Cooling system . . . . .	46- 53	53- 65
XI. Exhaust system . . . . .	54- 59	65- 72
XII. Fuel system . . . . .	60- 67	73- 85
XIII. Engine lubrication system . . . . .	68- 72	85- 93
XIV. Engine electrical system . . . . .	73- 80	94-114
XV. Generating system . . . . .	81- 90	114-124
XVI. Instrument panel and instru- ments . . . . .	91-114	125-141
XVII. Painting . . . . .	115-120	141-143
XVIII. Storage and shipment . . . . .	121-123	144-147
XIX. References . . . . .	124-125	148-149
<b>INDEX</b> . . . . .		150-155

\* This manual supersedes paragraph 84 in TM 9-370, dated 31 December 1942.

GENERATING UNIT M7

PART ONE—OPERATING INSTRUCTIONS

Section I

INTRODUCTION

	Paragraph
Scope .....	1
Characteristics .....	2
Differences among models .....	3
Data .....	4

1. SCOPE.

a. This manual is published for the information of the using arms and services.

b. In addition to a description of the Generating Unit M7, this manual contains technical information required for the identification, use, and care of the materiel.

c. Disassembly, assembly, and such repairs as may be handled by using arm personnel may be undertaken only under the supervision of an officer or the chief mechanic.

d. In all cases, where the nature of the repair, modification, or adjustment is beyond the scope or facilities of the unit, the responsible ordnance service should be informed so that trained personnel with suitable tools and equipment may be provided, or proper instructions issued.

2. CHARACTERISTICS.

a. The Generating Unit M7 (figs. 1, 2, and 3) is a gasoline engine actuated generator mounted on a specially designed rubber-tired trailer or on wood skids. The frame is of welded structural steel construction. It is bolted to the floor of the trailer. The engine and generator assembly is enclosed by a sheet metal canopy bolted to a base frame. Side doors give access to the instrument panel, engine, generator, and other parts within the canopy (figs. 4 and 5).

b. A 10-gage, sheet-steel instrument and control panel is located over the generator on the left-hand side of the unit.

c. The Generator Trailer M7, illustrated in figures 3 and 4, is designed primarily for travel on highways, and to afford a solid operating foundation for the generating unit. Four built-in corner lift jacks

## INTRODUCTION

(fig. 4) give firm ground contact, and lift the weight off springs and tires. The trailer can be coupled to any vehicle equipped with a pintle hook. Brakes and lights operate electrically from any vehicle having a suitable outlet and controller. A retractable parking wheel supports the drawbar when the trailer is uncoupled. For generator trailer operating instructions, see TM 9-881.

d. Some Generating Units M7 are mounted on Generator Skids M1 instead of on the trailer. The skids are 3-inch by 6-inch oak runners, bolted to the under side of the generator platform. They facilitate handling of the unit in loading and unloading from the truck on which it is carried.

### 3. DIFFERENCES AMONG MODELS.

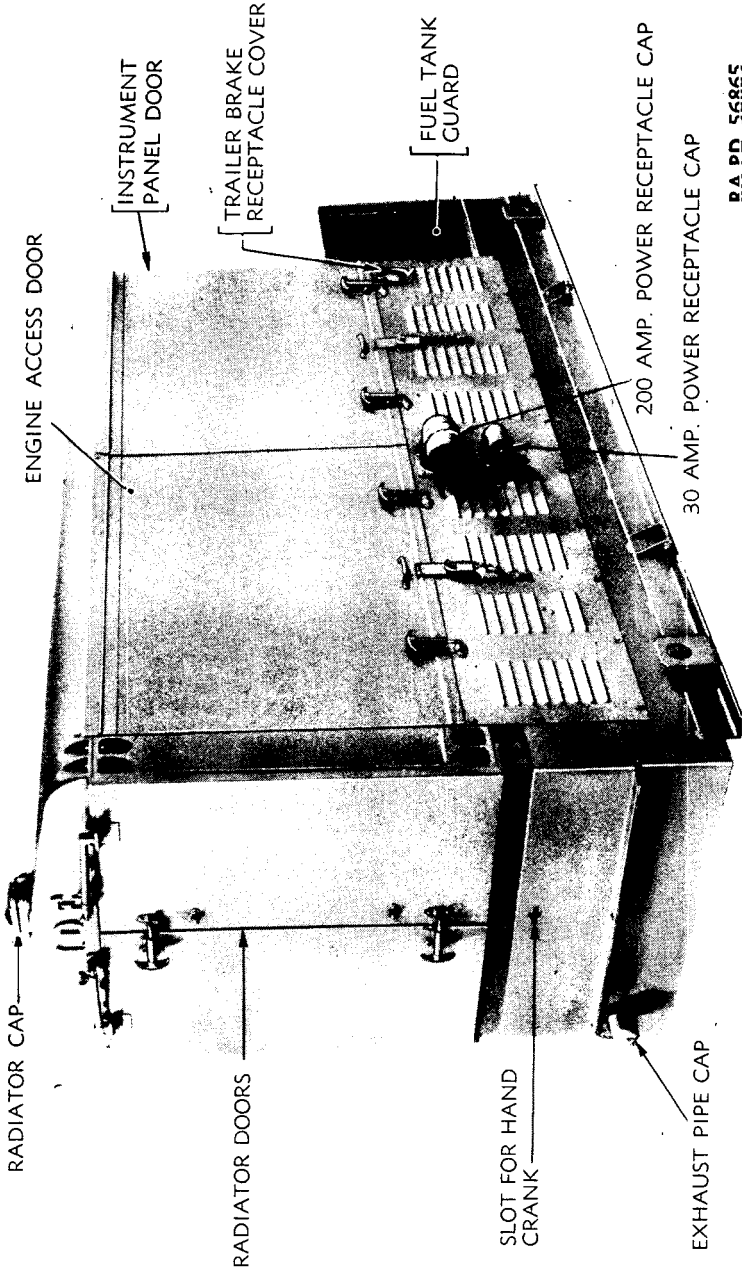
a. Generating Units M7 have been produced by five manufacturers, namely: International Diesel Electric Co., Cummings Diesel Engine Co., Hobart Bros., U. S. Motors Co., and Detroit Wax Paper Co. The name of the manufacturer of a unit will be found on plates attached to the instrument panel and to the rear panel of the canopy. Initials or name appears on radiators except for Cummings Diesel Engine Co. units, which have blank radiators. Information and instructions given in this manual cover all M7 Units. Whenever major differences in units of certain manufacture occur, or changes in procedure are necessary, supplementary information or instructions are given, identified by the initials of the manufacturer. There are no primary differences in manufacture which would affect troop use or care, with the exception of the Hobart unit, which has the generator exciter mounted on the same shaft, and within the same housing as the generator rotor.

b. **Generating Unit M7A1.** The designation Generating Unit M7A1 has been assigned to all Generating Units M7 which have been modified by the addition of a voltage regulator to the unit. The voltage regulator is designed to hold the voltage variation to within  $\pm 2$  percent from full load to no load operation.

### 4. DATA.

Length, over-all	100½ in.
Width, over-all	40⅞ in.
Height, over-all	56¾ in.
Weight, less fuel and water	4,297 lb
Fuel capacity	26 gal
Cooling system capacity	36 qt
Crankcase capacity	7 qt
Rated generator output	35-kva, 28-kw, 3-phase, 60-cycle, 125-v

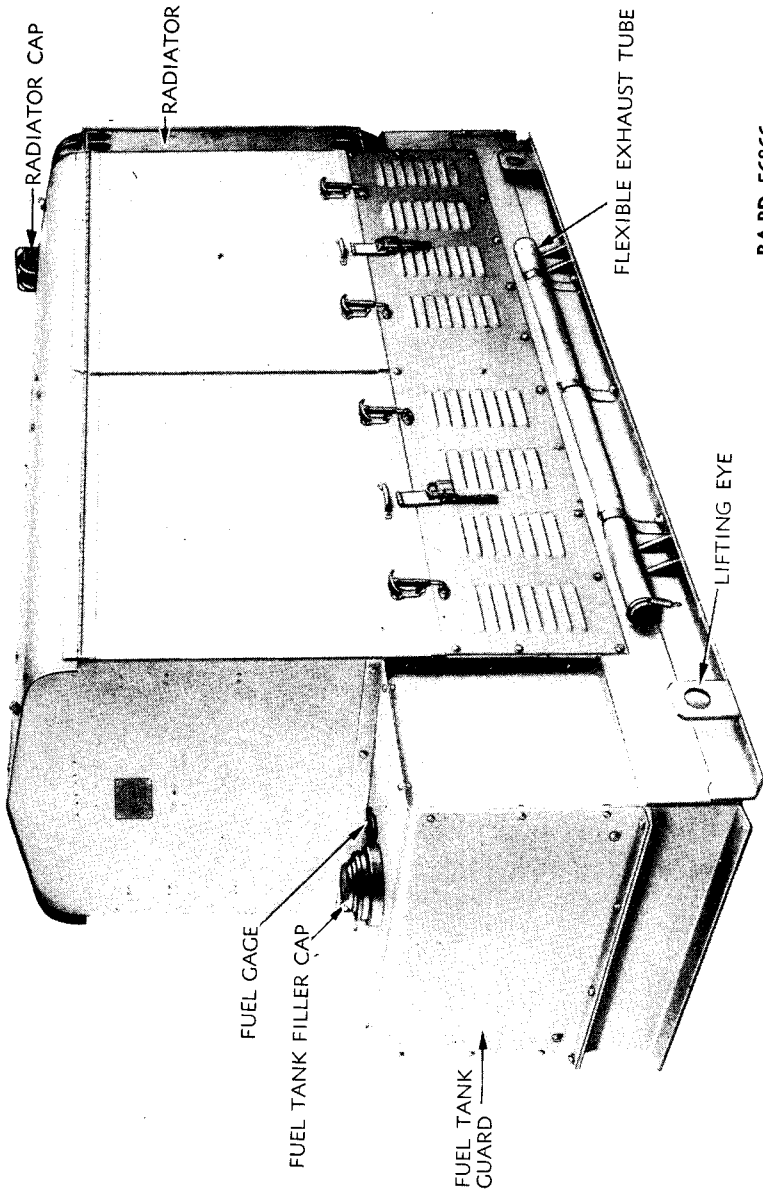
GENERATING UNIT M7



P.A. PD 56855

Figure 1—Generating Unit M7—Left Front

INTRODUCTION

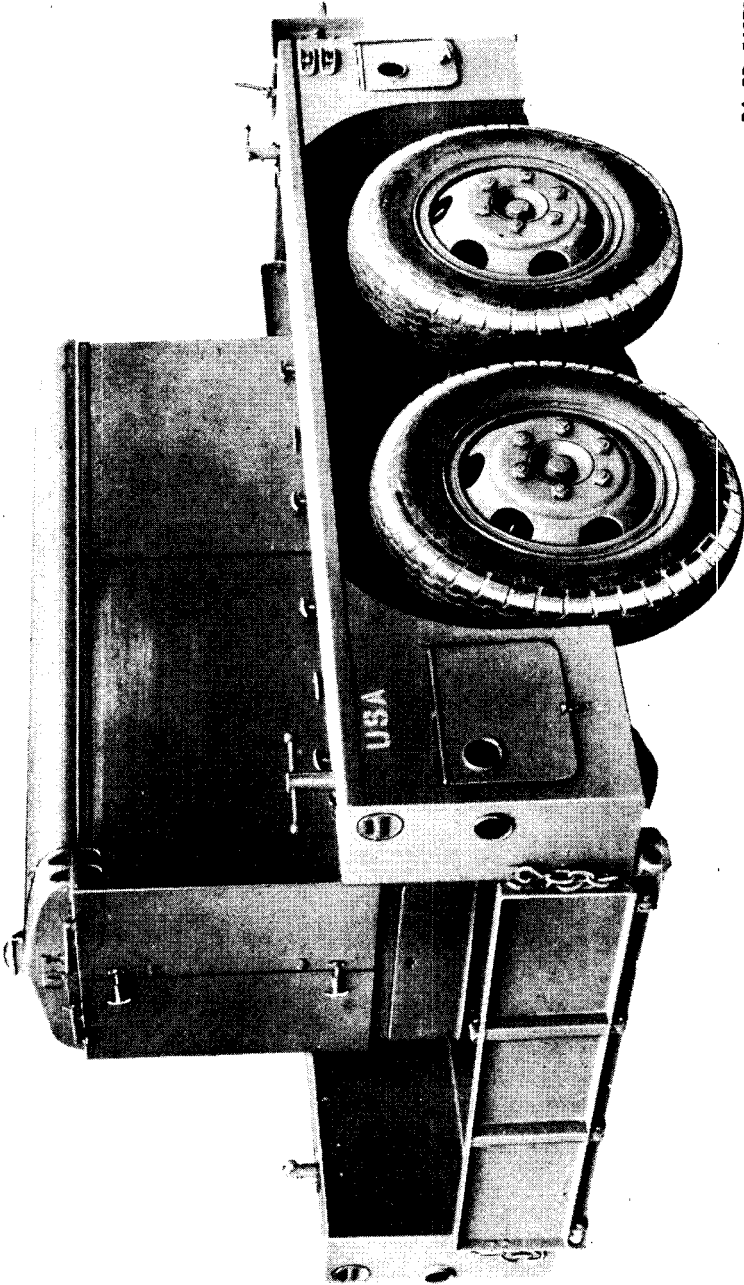


RA PD 56866

Figure 2—Generating Unit M7—Right Rear



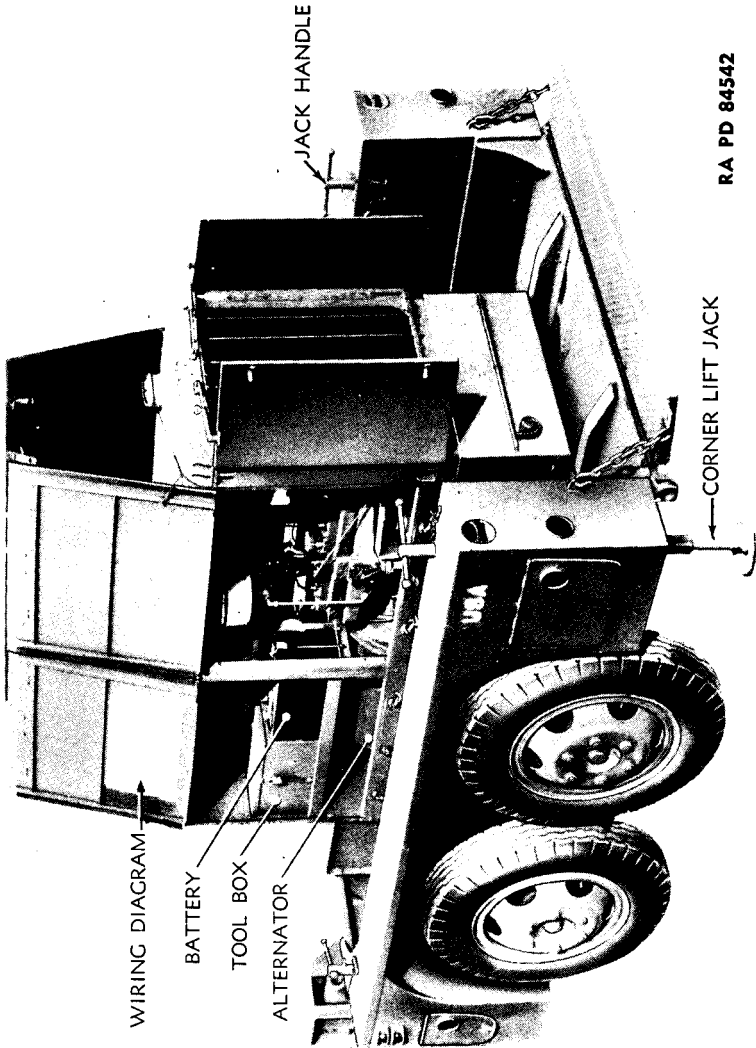
GENERATING UNIT M7



RA PD 56871

Figure 3—Generating Unit M7 and Generator Trailer M7—Ready to Be Moved

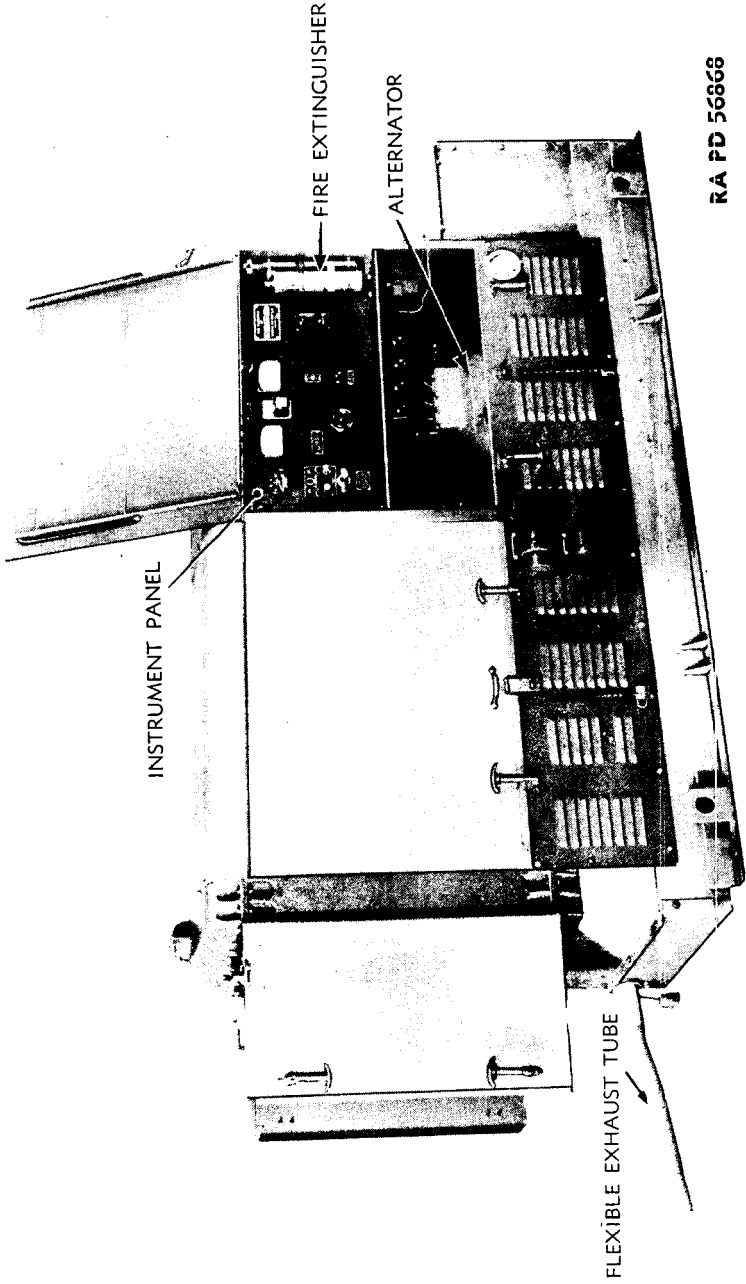
INTRODUCTION



RA PD 84542

Figure 4—Generating Unit M7 and Generator Trailer M7—All Doors Open

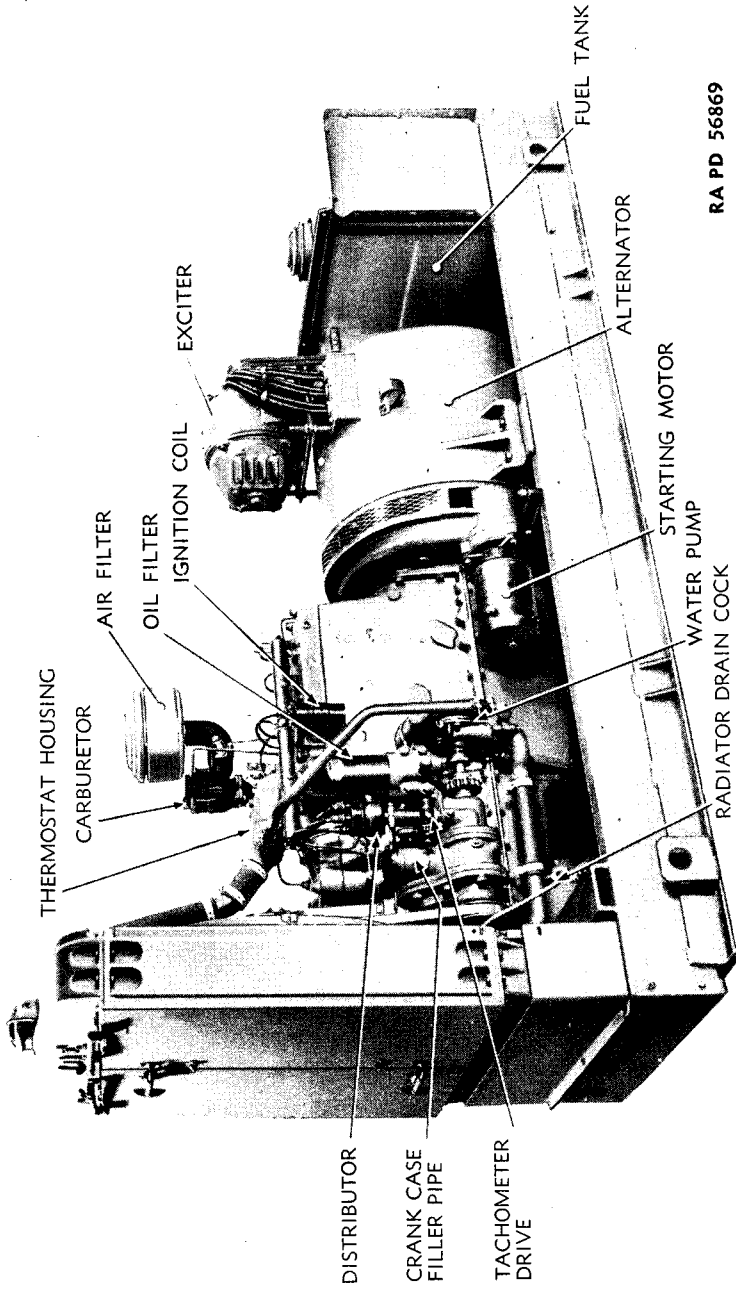
GENERATING UNIT M7



RA PD 56868

Figure 5 — Generating Unit M7 — Operating View

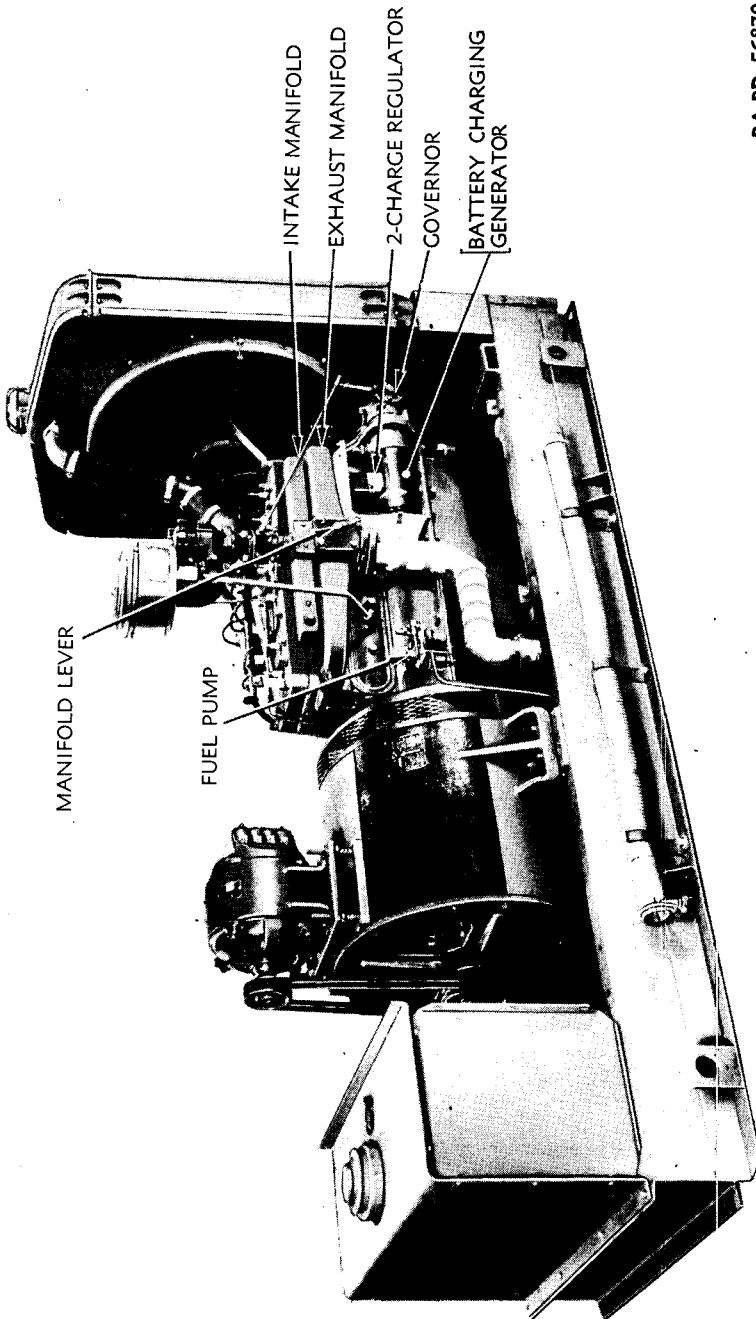
INTRODUCTION



RA PD 56869

Figure 6—Generating Unit M7—Canopy Removed—Left Side

GENERATING UNIT M7



RA PD 56870

Figure 7—Generating Unit M7—Canopy Removed—Right Side

Section II

OPERATION AND CONTROLS

	Paragraph
Preparing for first operation of generating unit . . . . .	5
Engine and generator controls . . . . .	6
Starting the unit . . . . .	7
Operating the unit . . . . .	8
Stopping the unit . . . . .	9
General care and precautions . . . . .	10

**5. PREPARING FOR FIRST OPERATION OF GENERATING UNIT.**

**a. Battery.**

(1) The battery is shipped dry, with the plates in a charged condition. Vent plugs are screw-tight with sealing disks, and must remain so until the cells are filled with electrolyte. Store in a cool dry place, away from direct sunlight, radiation, or heating devices.

(2) Before using, the battery must be filled with electrolyte, and given a freshening charge by ordnance personnel.

**b. Lubricating Oil.**

(1) Fill the engine crankcase oil pan (through the filler pipe) to the proper level, as indicated by the "4/4" or "FULL" mark on the bayonet-type level gage (fig. 17). Since allowance must be made for the oil filter capacity, it will be necessary to run the engine a few minutes, recheck the level, and add oil to the "4/4" or "FULL" mark.

(2) Use the grade of engine oil specified in Lubrication Guide (fig. 13), or for temperatures below zero degree F, in paragraph 27.

**c. Cooling Water.**

(1) Fill the radiator with 36 quarts of clear water, using the softest available. Be sure the radiator drain cock is closed.

(2) For operation below 32 degrees F, the following mixture should be added to the radiator: To 10 parts by volume of water, add the following parts by volume of COMPOUND, antifreeze, after draining off an appropriate quantity of water:

Temperature (degrees F)	Water (parts by volume)	COMPOUND, antifreeze (parts by volume)
+20	10	2
+10	10	3 1/3
0	10	5
-15	10	7 1/4
-30	10	10
-40	10	12

GENERATING UNIT M7

- A-ALTERNATOR
- B-TEMPERATURE GAGE
- C-OIL PRESSURE GAGE
- D-BATTERY CHARGING AMMETER
- E-125 V. BULB
- F-TACHOMETER
- G-VOLTMETER
- H-6 V. LIGHT
- J-METER SWITCH
- K-LAMP DIMMING RHEOSTAT
- L-NAMEPLATE
- M-AMMETER
- N-125 V. LIGHT SWITCH
- P-LOAD SWITCH
- Q-SWITCHBOARD APRON
- T-SLOT RECEPTACLE FOR 125 V
- R-TROUBLE LIGHT AND POWER
- U-TOOLS
- S-FIELD RHEOSTAT
- T-STARTER BUTTON
- U-CONTROL GROUP
  - 1-THROTTLE
  - 2-IGNITION SWITCH
  - 3-6 V. RECEPTACLE
  - 4-6 V. LIGHT SWITCH
  - 5-CHOKE

RA PD 64537

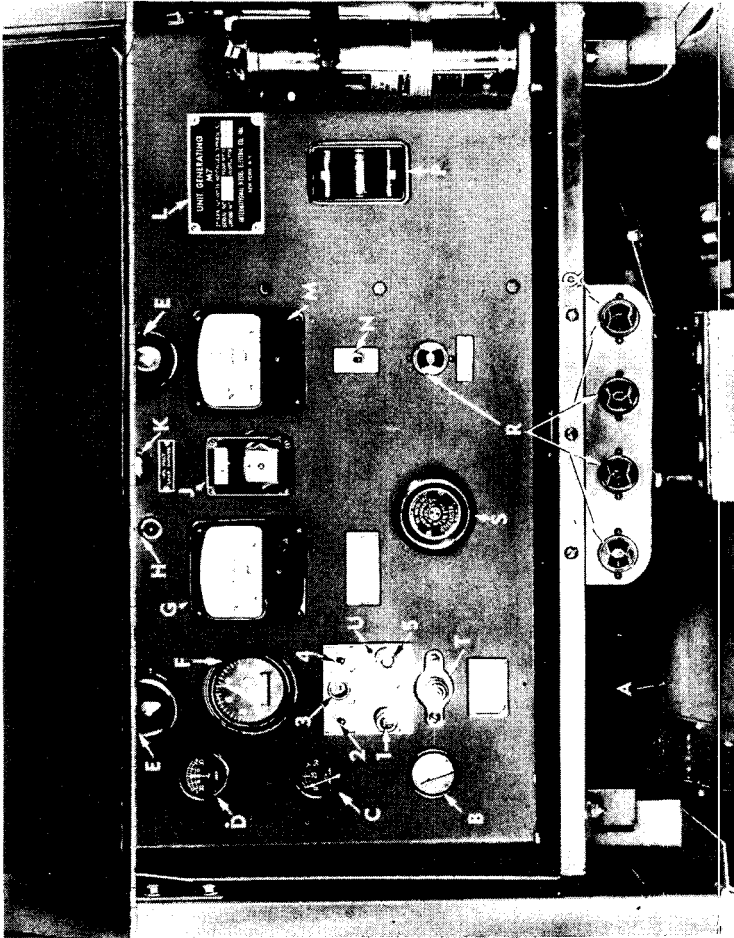


Figure 8 -- Instrument Panel

## OPERATION AND CONTROLS

**NOTE:** Immediately start the engine, and run at idling speed without load until warm, to mix thoroughly the antifreeze and water solution.

**d. Fuel.** Fill the fuel tank with 26 gallons of gasoline. Fuel consumption (72 octane fuel) will be at the rate of approximately 1 gallon per 6 kilowatt hours at rated load of 28 kilowatts. When using 80 octane fuel, the output of the generating unit is approximately 10 percent higher than when using 72 octane fuel.

### 6. ENGINE AND GENERATOR CONTROLS (fig. 8).

**a. Choke.** The use of the choke, located at lower right in the control group on the left-hand side of the instrument panel, depends mainly on the climate in which the unit is operating. In cold climates, it should be pulled all the way out, and kept in this position for the first few revolutions of the engine crankshaft. In warm climates, this is seldom necessary. The choke should always be used as sparingly as possible.

**b. Throttle.** The throttle is at the lower left in the control group on the left-hand side of the instrument panel. Its use is normally confined to the starting and stopping of the engine. The engine is started with the throttle all the way in. As soon as the engine begins to fire, the throttle is pulled out quickly, until the speed indicated on the tachometer is approximately 600 rpm. As the engine warms up sufficiently for full speed operation, the throttle is gradually pushed in. When stopping the engine, the throttle is pulled to full out position, and the engine allowed to idle for a minute before the ignition is turned off, otherwise, backfire might damage muffler.

**c. Doors.** While the unit is running, both radiator doors are usually fastened open. For quick warming up in cold weather, the doors may be kept closed until the desired engine temperature is obtained. While the unit is running, the instrument panel door is open, and fastened back, with the chain provided, or with door props during rainy weather. Other canopy doors are kept closed, unless their use is required to help adjust the temperature.

**d. Field Rheostat.** The field rheostat, located on the lower left center of the instrument panel, controls the output voltage of the generating unit. Turning the knob counterclockwise increases the voltage delivered.

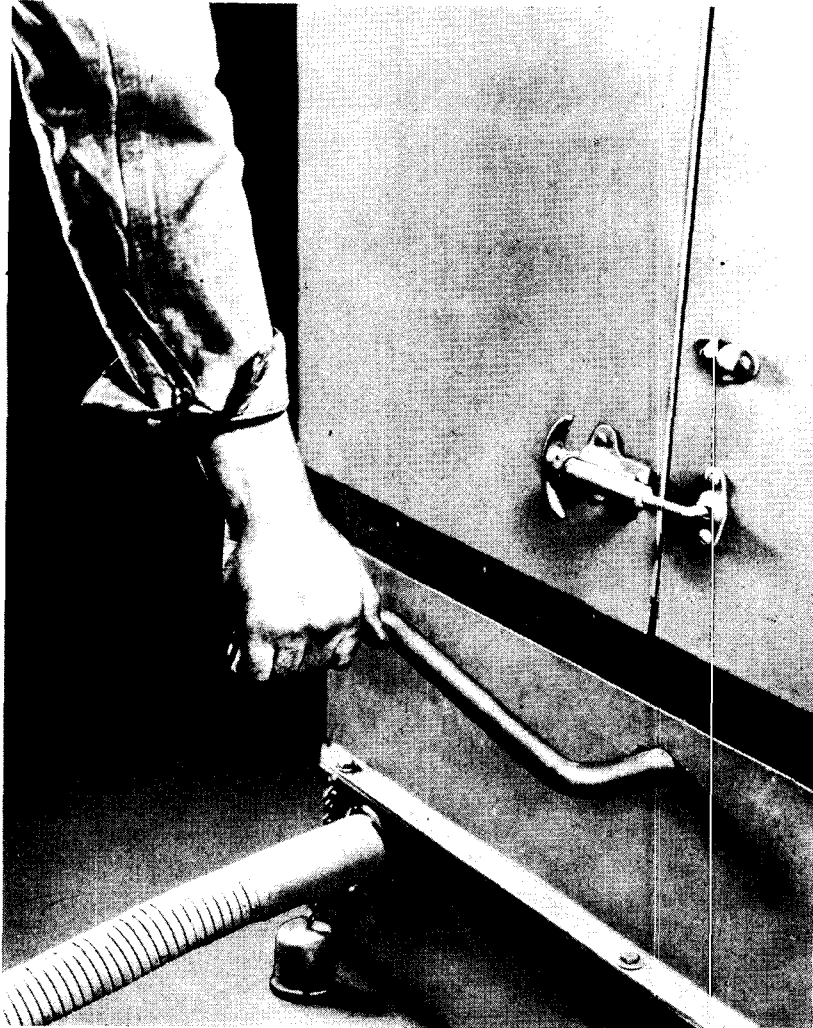
**e. Ignition Switch.** The ignition switch, which controls the 6-volt starting and ignition system, is at the upper left in the control group on the left side of the instrument panel.

**f. Starter Switch.** The starter, or cranking switch, is on the left side of the instrument panel, just below the throttle and choke controls.

**g. Meter Switch.** The meter switch used to check amperage and voltage is at upper center of the instrument panel.



## GENERATING UNIT M7



RA PD 56875

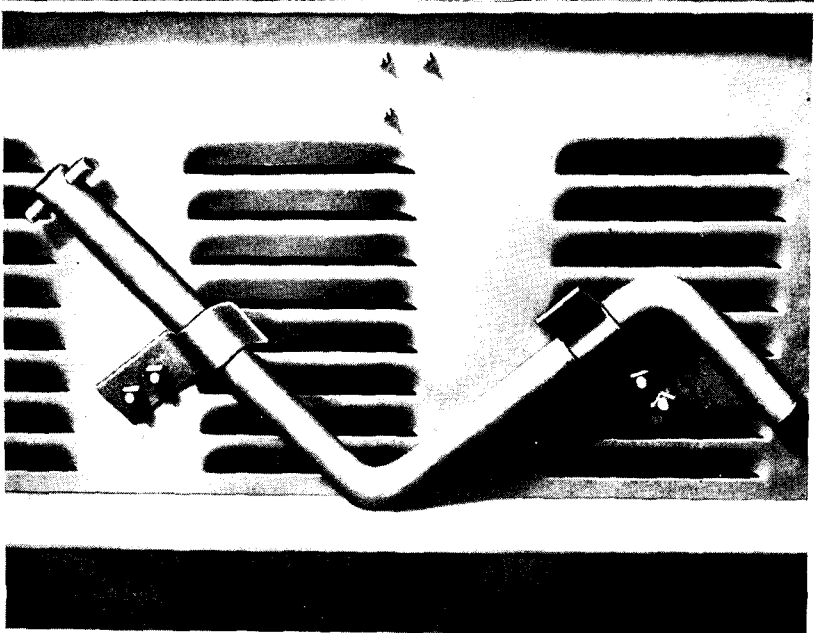
**Figure 9—Hand Cranking Engine**

**h. Voltmeter.** The voltmeter is centrally located on the instrument panel, at the left of the meter switch. This instrument indicates the voltage of the current generated, normally 125 volts.

**i. Ammeter.** The ammeter is centrally located on the instrument panel, to the right of the meter switch. This ammeter, in conjunction with the meter switch, indicates the amperage of current being delivered.

**j. Load Switch.** The switch, which starts and stops the delivery

## OPERATION AND CONTROLS



RA PD 56876

**Figure 10—Crank in Holding Clips Against Left Side Panel**

of power to the load, is on the right-hand side of the instrument panel, directly below the unit name plate.

**k. Tachometer.** The tachometer, which is just below the left-hand light on the instrument panel, indicates the number of revolutions per minute. Also on the tachometer is an odometer dial, which records the total number of revolutions.

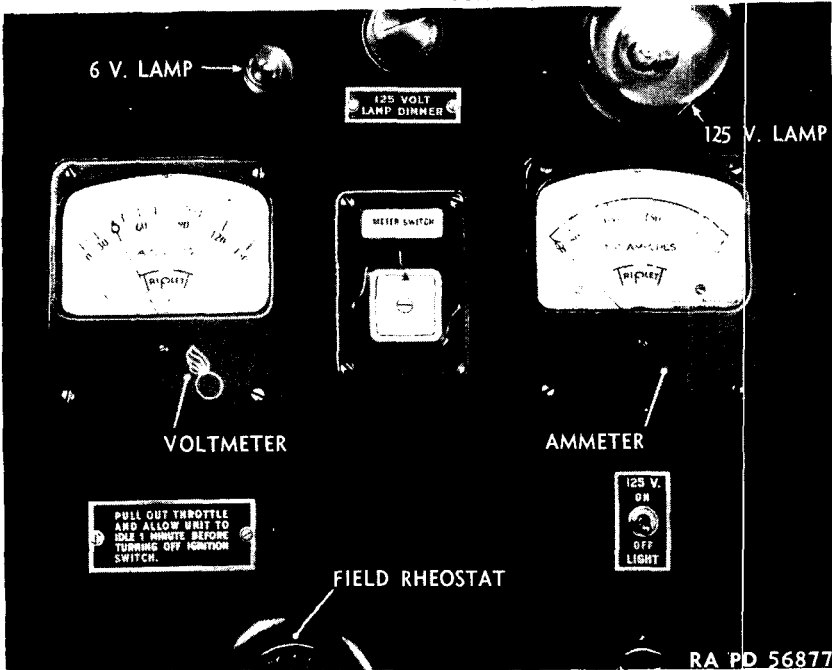
**l. Temperature Gage.** The engine temperature gage is at the lower left-hand side of the instrument panel. The engine running temperature should be between 160 degrees F and 180 degrees F.

**m. Oil Pressure Gage.** The oil pressure gage is at the extreme left center of the instrument panel. The pressure should be approximately 25 pounds at 1,200 rpm.

**n. Battery-charging Ammeter.** The battery-charging ammeter is located in the upper left-hand corner of the instrument panel.

**o. Fuel Gage.** A mechanical-type fuel gage set into the tank is used on International Diesel Electric Company, Cummings Diesel Engine Company, and Hobart units. Units manufactured by U. S. Motors Company have an electric fuel gage mounted on the instrument panel.

GENERATING UNIT M7



**Figure 11—Voltmeter and Meter Switch—Showing Correct Exciter Indication**

p. **Lamp-dimming Rheostat.** The lamp-dimming rheostat, used to dim the 125-volt lamps, is located at the top center of the panel.

q. **Frequency Meter.** Some generating units employ a vibrating reed type frequency meter in place of a tachometer to determine engine speed and a-c frequency output. Normal engine speed (1,200-rpm) and a-c frequency output (60 cycles) are indicated when the reed over the 60-line on the instrument reaches its maximum vibration, with adjacent reeds vibrating less vigorously.

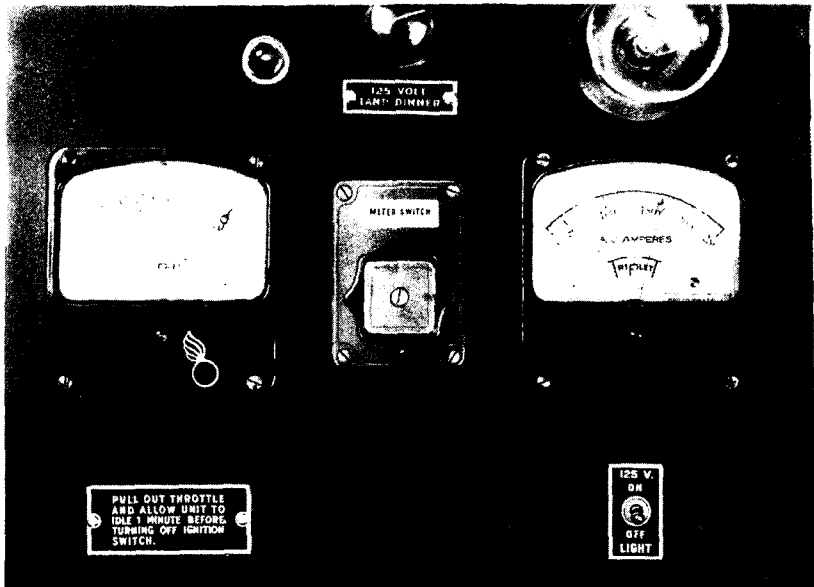
## 7. STARTING THE UNIT.

a. **First Starting.** For starting the unit for the first time, see paragraphs 5 and 12, then proceed as outlined below.

### b. Preliminary Instructions.

- (1) Make sure that the load switch handle is in the "OFF" position.
- (2) See that the fuel valve (located next to the gas tank in the fuel line) is open.
- (3) Remove exhaust pipe cap, and connect exhaust tube.
- (4) Remove power receptacle cap, and connect plug (fig. 1).

## OPERATION AND CONTROLS



RA PD 56878

**Figure 12—Voltmeter and Ammeter—Showing Correct Reading for a Circuit Phase**

(5) Be sure that the field rheostat knob has been turned clockwise as far as possible.

**c. Warming Up.**

(1) Pull out the choke, if necessary.

(2) See that the throttle is pushed in all the way.

(3) Start the engine by placing the ignition switch in the "ON" position, and pressing the starter switch until the engine fires. If starting after all previous fuel has been drained or consumed, a longer period of time will be required before fuel reaches the carburetor and the engine fires. **NOTE:** On occasion, it will be found that oil has been added to the top of each cylinder of the power plant prior to shipment, to prevent rusting. When starting for the first time, a unit which has been treated in this manner, smoking will most likely result until this oil is burned out.

(4) When the engine fires, pull out the throttle quickly until the tachometer indicates about 600 rpm. Keep the engine at that speed until it is sufficiently warmed up for full speed operation, then gradually push in the throttle.

**d. Hand Crank Starting.** To start the generating unit with the hand crank, be sure both the load and ignition switches are in the "OFF" position. Pull choke all the way out, then give the hand crank two complete turns. Readjust choke so that it is one-third out, and

**GENERATING UNIT M7**

turn ignition "ON." Give hand crank (fig. 10) a quick turn, by pulling up from the bottom (fig. 9).

**8. OPERATING THE UNIT.**

a. **Load Switch.** The first step, to begin the delivery of current from the generator to the load connected to the power outlets, is to pull the load switch handle (at extreme right on the instrument panel) to the "ON" position.

b. **Voltage Control.** To provide the requisite voltage for the power receptacle line (normally 125), slowly rotate the field rheostat control handle counterclockwise until the voltmeter indicates 125.

c. **Load Meter.** To check the voltage of the exciter, the amperage of the current being delivered to each of the three phases of the connected load, and the voltage between phases, the meter switch is provided. The four positions of the control knob, "EXC," "A," "B," and "C," are labeled on the face plate of the switch. When the indicating mark on the control knob is turned to "EXC," the exciter voltage is reflected on the voltmeter (fig. 11). As the switch turns to the "A," "B," and "C" phases of the circuit, the amperage and voltage show on the ammeter and voltmeter (fig. 12). The average of the three readings on the ammeter should not exceed 162 amperes for continuous operation, or 202 amperes over a period of operation not to exceed 2 hours. The difference in ammeter readings should not exceed 10 percent of the average. If the load is largely of the resistance type, such as lighting or heating units, so that the power factor is higher than 80 percent, the current must be limited to approximately 129 amperes normal load, and 162 amperes overload, in order not to exceed the engine's rated capacity.

**d. Panel Illumination.**

(1) Two 125-volt bulbs are located in rubber sockets at the top of the panel. The light switch is at the right of the center of the panel, and the lamp-dimming rheostat is located between the lights. In field service, the illumination should be kept at as low a level as possible.

(2) As the 125-volt current is available only when the unit is operating, an auxiliary 6-volt light is provided at the top of the panel. A snap switch to control this is immediately above the choke handle.

**e. Trouble Lights.**

(1) The 125-volt trouble light, furnished with the unit and carried in the tool box, may be plugged into the T-slot receptacle on the panel proper, or into one of the four receptacles in the apron below.

(2) The 6-volt trouble light (also in the tool box) has a receptacle provided for it above the starter switch.

f. **Power Tools.** Power tools that may be used for repair or maintenance work on the unit can be plugged into the T-slot receptacles in the panel apron.

## OPERATION AND CONTROLS

**g. Temperature Control.** The running temperature of the engine should be maintained at 160 degrees F to 180 degrees F. To maintain a correct temperature, the radiator doors, the engine side doors, and the door behind the instrument panel can be opened or closed to suit climatic conditions. All doors are provided with means for holding them in the "OPEN" position.

**h. Battery-charging Ammeter.** The battery-charging ammeter indicates in amperes the rate of charge or discharge of the 6-volt battery. It is of the automotive type.

**i. Tachometer.** When the engine is running properly, the tachometer should indicate 1,200 rpm at full load, which will produce an alternating current of 60 cycles per second as required by the load. At less than full load, the speed will be slightly higher. The speed is shown in hundreds of revolutions per minute.

### 9. STOPPING THE UNIT.

**a. Load Switch.** First operation in stopping the unit is to disconnect the load by pulling the load switch handle down to the "OFF" position. When the unit is not in operation, this switch should always be off, thus avoiding the possibility of ever starting the engine with the load on.

**b. Rheostat.** The field rheostat knob should be turned clockwise as far as possible.

**c. Throttle.** The throttle is pulled out to bring the engine down to idling speed for *the full minute of idling* required before stopping. Otherwise, there is the chance of backfiring and muffler damage. The proper idling speed is 350 to 400 rpm.

**d. Ignition.** Final operation of stopping is to snap the ignition switch to the "OFF" position.

### 10. GENERAL CARE AND PRECAUTIONS.

**a.** The generating unit should be kept clean and adequately supplied with gasoline at all times. Lubrication and servicing should be in accordance with instructions set forth in sections IV and VI.

**b.** Exercise care to see that the main switch is always open, when connecting or disconnecting the power cable and, before starting the engine.

**c.** If the unit is used in any building or enclosure, be sure that a hose or pipe is attached to the exhaust pipe and run through an opening to the outside. Exhaust fumes and gases might prove harmful to the operating personnel.

**d.** Periodic examinations should be made to see that all electrical

**THE ARMY LIBRARY**

 **WASHINGTON, D.C.**

**GENERATING UNIT M7**

connections and leads are in good order and that the electrical indicators and controls are functioning properly. When not in use, see that the receptacle cover is screwed on the outlet receptacle.

e. Do not pour gasoline into the fuel tank while the engine is running, nor while the ignition switch is turned on.

f. Never permit the oil to fall below the "2/4" mark on the bayonet gage. On the other hand, do not overfill the crankcase, as this might raise the oil level to a point where the connecting rods would dip in and throw oil on cylinder walls, causing smoke, oil pumping, excessive carbon deposits, and fouled spark plugs. Fill only to the "4/4" or "FULL" mark on the gage rod, except as indicated in section VI, for operation below zero degree F.

**Section III**

**INSPECTION**

	Paragraph
Purpose .....	11
Prestarting inspection .....	12
Inspection during operation .....	13
Inspection after short operation .....	14
Inspection after long operation .....	15
Weekly and monthly inspections .....	16

**II. PURPOSE.**

a. Inspection of the generating unit is vital. Thorough systematic inspection at regular intervals is the best insurance against an unexpected breakdown at the critical moment when maximum performance is absolutely necessary. Never let the materiel run down. Keep it in first class fighting condition by vigilant inspection and prompt maintenance.

b. Inspection is for the purpose of determining the condition of the materiel, whether repairs or adjustments are required, and the remedies necessary to insure serviceability and proper functioning. Its immediate aim is trouble prevention, which includes:

- (1) Preventive maintenance.
- (2) Discovering evidence of improper treatment of the materiel before receipt.
- (3) Determining when replacement of parts is necessary because of ordinary wear or accidents.

## INSPECTION

e. The Chief of Ordnance should be advised (through the local ordnance officer) of any chronic troubles, technical failures, or unsatisfactory operation of any parts or units. Any suggestions for the improvement of the inspection procedure or handling technique (based on actual operating experience) should likewise be forwarded so that all units may benefit.

### 12. PRESTARTING INSPECTION.

a. Check fuel supply, engine oil, water, or antifreeze solution in radiator, lubrication, and specific gravity of battery electrolyte. Inspect glass sediment cup on fuel pump; empty, if water is present.

b. Examine engine and trailer floor for leaks from radiator, fuel tank, water, fuel, or oil lines. Examine all lines for leaks.

c. Check unit for loose parts and loose electrical connections.

d. Check fuses and instrument panel lights.

e. Inspect all brushes, slip rings, and commutators for necessary servicing or replacement.

f. Check tension on exciter and radiator fan belts.

g. Examine mounting and other important bolts, and tighten, if necessary.

h. Check tools, spare parts, and fire extinguisher.

i. See that the radiator core is clear.

j. See that the exhaust hose is in place.

k. Make sure the load switch is "OFF."

l. Make sure field rheostat is turned as far as possible in clockwise direction.

### 13. INSPECTION DURING OPERATION.

a. **Constant Attention.** While the unit is running, the operator should be constantly alert to detect abnormal functioning. He should be trained to detect unusual engine noises. He should quickly be conscious of overheating or of the smell of burning insulation.

b. **Instruments.** All instruments should be inspected at regular intervals during operation. Special attention should be given to the amperage developed. Check the three phases of the circuit as described in paragraph 8 c. The battery-charging ammeter will not always indicate charging. If the battery is fully charged, the charging generator will not operate. Just after starting, however, the ammeter should indicate charging.



## GENERATING UNIT M7

### 14. INSPECTION AFTER SHORT OPERATION.

a. **General.** The inspection after a short period of operation should roughly duplicate the prestarting inspection, with the addition of a check of running parts.

b. **Leaks, etc.** Examine fuel, water, and oil lines for leaks. Fill the fuel tank. If necessary, change the engine oil, or add oil to maintain the correct level (fig. 13). Add water or antifreeze solution to radiator, if required.

c. **Running Parts.** Check all running parts for evidence of overheating. Examine electric wiring for breaks or loose connections. The best check on running parts is made after a short period of operation. Insert the hand crank for hand starting. Running parts are functioning freely if the crank can be turned without too much effort.

d. **Nuts and Bolts.** Check tightness of bolts and nuts.

### 15. INSPECTION AFTER LONG OPERATION.

a. **General.** After each lengthy period of operation, an exhaustive check should be made for any actual or incipient failure of parts or equipment. Replacements made from the spare parts supply should be listed for renewal.

b. **Lines.** All tubing and pipe lines must be examined for leaks. Joints and fittings must be tested for tightness. Gaskets must be checked, and replaced where necessary.

c. **Electrical.** Electrical equipment, including all switches and instruments, must be subjected to a thorough examination and test.

d. **Clearances.** Spark plug, distributor point, and valve tappet clearances must be checked.

e. **Lubrication.** Special attention must be given to the lubricating system. See sections IV and XIII.

f. **Tools and Fire Extinguisher.** Tools are checked against the tool list, and missing tools reported. The fire extinguisher must be examined, and the piston head leather given 1 or 2 drops of OIL, engine, SAE 10. Refill, if necessary.

g. Check battery electrolyte.

h. Examine belts for wear, or for the necessity of adjustment.

i. Check light bulbs and fuses.

j. Examine muffler for cracks.

### 16. WEEKLY AND MONTHLY INSPECTIONS.

a. Inspections at stated intervals, regardless of the amount of actual service the unit has given during the period, are valuable because they will bring to light not only operational mechanical failures, but also troubles due to deterioration which can occur even when the unit has not been in operation.

**INSPECTION**

b. Weekly inspections will at least duplicate the inspection after long operation. In these weekly inspections, the possible effects of unusual climatic conditions or conditions of terrain should be taken into consideration and checked as detailed in section VI.

c. Monthly inspections should be the most exhaustive possible. Check list is given below:

(1) **FRAME AND CANOPY.** Examine connecting nuts and bolts for tightness.

(2) **ENGINE.**

(a) Check crankcase, block, head, and head gasket for cracks or leaks. See that all bolts are tight.

(b) Remove valve covers and examine valve rods, springs, and valve clearances. Renew cover gaskets, if necessary.

(c) Run engine, and listen for piston slap, bearing knock, or carbon knock.

(d) Check oil pressure. If below normal, it may indicate loose engine bearings.

(3) **COOLING SYSTEM.**

(a) Examine radiator and connections for signs of leakage, clogging, or damage.

(b) Inspect fan and supporting bracket.

(c) Check belt for proper tension, for cracks, or for oil soaking.

(d) Examine water pump for cracks and leaks. Make sure the shaft rotates freely.

(4) **EXHAUST SYSTEM.**

(a) Examine manifold for cracks.

(b) Check manifold gaskets for leaks.

(c) Examine muffler and exhaust pipe for cracks.

(5) **FUEL SYSTEM.**

(a) Inspect fuel pump, fuel pump mounting, and connections. Empty the sediment cup, and clean the fuel filter.

(b) Examine carburetor for tightness of screws, and for worn gaskets.

(c) Inspect air cleaner. Clean element, and change oil.

(d) Check choke and throttle action, and examine linkage.

(e) Inspect fuel tank and fuel lines for signs of leaks.

(6) **LUBRICATING OIL SYSTEM.**

(a) Check oil pressure.

(b) Check all oil lines and connections to governor and to oil pressure gage.

(c) Clean oil strainer.

(7) **ENGINE ELECTRICAL SYSTEM.**

(a) Inspect all wires and terminals for damage, wear, and looseness.

**GENERATING UNIT M7**

- (b) Examine and test starter and switches.
- (c) Test battery, and check battery electrolyte.
- (d) Inspect distributor. Remove cap and examine for cracks.

Inspect breaker points, spring, rotor, and cap inserts for signs of pitting and burning. Check cam for evidence of wear.

(e) Test the action of the starting motor. Inspect commutator and brushes for dirt or signs of wear.

(f) Check battery-charging generator action for excessive arcing at the brushes. Examine for sticking or worn brushes, and burned commutator bars.

(8) **GENERATING SYSTEM.**

(a) Check amperage and voltage of current delivered. Inspect alternator brushes for signs of wear, proper spring pressure, and freedom of action in holders. Examine brush holders to see if they are clean.

(b) Check exciter brushes for signs of wear, proper spring pressure, and freedom of action in holders. Inspect condition of brush holders, brush holder rod insulating washers, and pigtail connections. Check commutator for roughness or low, loose, or high bars.

(c) Check belt tension.

(9) **INSTRUMENT PANEL.**

- (a) Check tightness of mounting bolts.
- (b) Inspect for loose wires or connections.
- (c) Check all fuses.

**Section IV**

**LUBRICATION**

	Paragraph
Introduction .....	17
Lubrication guide .....	18
Points to be serviced and/or lubricated by ordnance maintenance personnel .....	19
Reports and records .....	20

**17. INTRODUCTION.**

a. Lubrication is an essential part of preventive maintenance, determining to a great extent the serviceability of parts and assemblies. Materiel must be lubricated in accordance with the latest instructions contained in Technical Manuals and Ordnance Field Service Bulletins. Lubricating fittings are identified by a red circle  $\frac{3}{4}$  inch in diameter.

## LUBRICATION

### 18. LUBRICATION GUIDE.

a. **General.** Lubrication instructions for this materiel are consolidated in a Lubrication Guide (fig. 13). These specify the points to be lubricated, the periods of lubrication, and the lubricant to be used. **NOTE:** The Lubrication Guide and notes set forth below cover both the Generating Unit M7 and Generator Trailer M7. They agree with the Lubrication Guide packed with the materiel, which at the present time covers both of these items in one guide. TM 9-881 is the Operators Manual for the Generator Trailer M7.

b. **Notes.** The following notes apply to the Lubrication Guide (fig. 13). Any note reference in the Lubrication Guide itself is to the subparagraph below having the corresponding number. For lubrication and service below zero degree F, refer to section VI.

(1) **FITTINGS.** Clean before applying lubricant. Lubricate until new lubricant is forced from the bearing, unless otherwise specified. **CAUTION:** Lubricate trailer points after washing.

(2) **INTERVALS.** Those indicated are for normal service. For extreme conditions of speed, heat, water, sand, mud, snow, rough roads, dust, etc., reduce interval on guide by one-third or one-half or more, if conditions warrant.

(3) **CLEANING.** **SOLVENT**, dry-cleaning, or **OIL**, fuel, Diesel, will be used to clean or wash all parts. Use of gasoline for this purpose is prohibited. All parts will be thoroughly dry before relubrication.

(4) **AIR CLEANER.** Daily, check level, and refill oil reservoir to bead level with used crankcase oil or **OIL**, engine, SAE 30 above +32 degrees F, and SAE 10 from +32 degrees F to zero degree F. Below zero degree F, remove oil, and operate dry. Every 150 hours or daily, if operating in extreme dust conditions, remove entire assembly. Clean entire air cleaner and air pipes. Proper maintenance of air cleaners is essential to prolonged engine life.

(5) **CRANKCASE.** Drain only when engine is hot. Every 50 hours, drain, and refill to "FULL" mark on gage. Run engine a few minutes, and recheck oil level. **CAUTION:** Be sure pressure gage indicates oil is circulating.

(6) **OIL FILTER.** Before draining crankcase oil, remove plug on filter which covers the oil reversing valve and, with the engine running, drain 2 quarts of oil. Stop engine and drain crankcase. After draining, remove filter shell, and scrape sludge from filter felts. Clean filter shell, and reassemble. Refill crankcase to "FULL" mark on gage. Run engine a few minutes, recheck level, and add oil to "FULL" mark.

(7) **FAN.** If grease lubricated, remove plug and insert fitting to lubricate fan bearings. Replace plug. If oil lubricated, use hand oiler.

(8) **DISTRIBUTOR.** Every 200 hours, wipe distributor breaker cam

GENERATING UNIT M7

RA PD 84535

Interval • Lubricant

- 1 CG LUNETTE SWIVEL  
(Models so equipped)
- 1 CG LUNETTE SOCKET  
(Models so equipped)
- 1 CG CASTER SUPPORT SWIVEL  
AND ELEVATING WORM BRG.
- 1 CG CASTER WHEEL BEARINGS
- 1 CG HAND BRAKE SHAFT BEARING
- 1 CG HAND BRAKE SCREW BEARING
- 1 CG HAND BRAKE SHAFT BEARING

Serviced From Under Hood

KEY	
LUBRICANTS	
OE	OIL, engine
	Except crankcase
	SAE 30 (above +32°F.)
	SAE 10 (-32°F. to 0°F.)
	PL (below 0°F.)
CG	GREASE, general purpose
	No. 1 (above +32°F.)
	No. 0 (below +32°F.)
WB	GREASE, general purpose, No. 2
WP	GREASE, water pump
GL	GREASE, lubricating, special
PL	OIL, lubricating, preservative, light

CAUTION—Lubricate Dotted Arrow Points on Both Sides. Points on Opposite Side are indicated by Dotted Short-Shaft Arrows.

Lubricant • Interval

- HAND BRAKE SHAFT BEARING CG 1
- LEVELING JACK CG 1
- ROCKER ARM GIB PLATE CG 1,  
GUIDE BEARINGS
- WHEEL BEARINGS WB 6  
(Remove, clean and repack)
- SPRING HANGER GIB PLATE CG 1,  
GUIDE BEARINGS
- SPRING HANGER FULCRUM CG 1,  
PIN BEARING
- 200 GL GENERATOR SHAFT BEARING  
(Refill cup, turn 1 full turn)  
(For disassembly, Note 12)
- 200 GL EXCITER SHAFT BEARINGS  
(Some models) (Refill  
cups, turn 1 full turn)

LUBRICATION

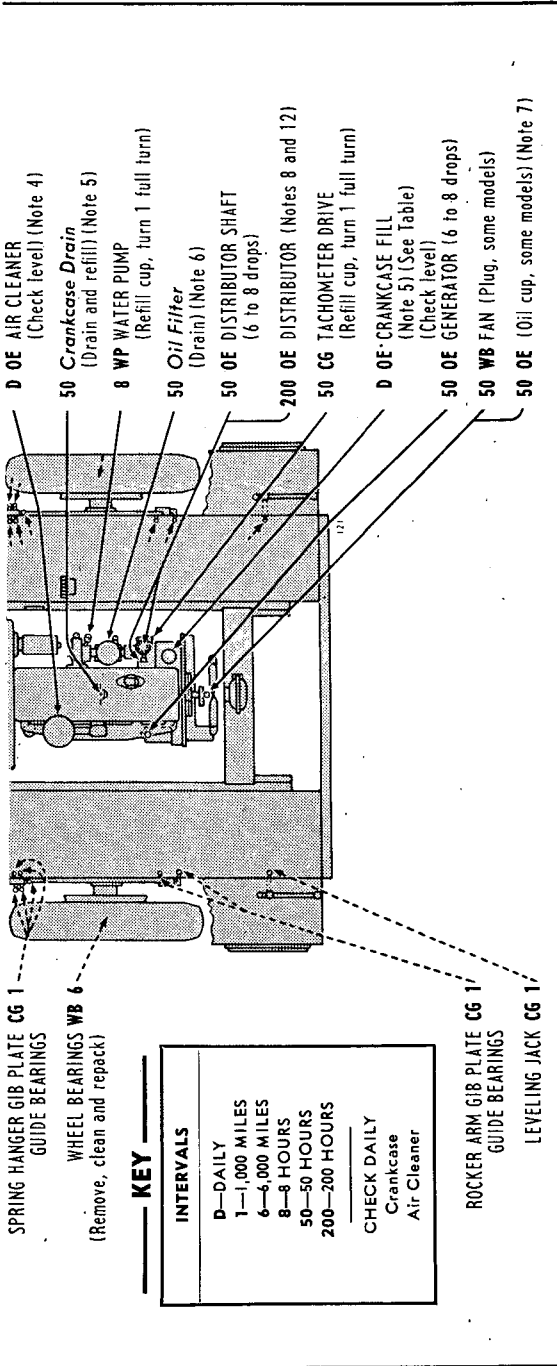


TABLE OF CAPACITIES AND LUBRICANTS TO BE USED

UNIT	CAPACITY (Approx.)	LOWEST EXPECTED AIR TEMPERATURE	
		+32° F. and above	+32° F. to 0° F.
Crankcase	7 qt.	OE SAE 30	OE SAE 10 Refer to OFSB 6-5

RA PD 84535A

Figure 13—Lubrication Guide—Generating Unit M7 and Generator Trailer M7

## GENERATING UNIT M7

lightly with GREASE, general purpose, No. 1 above +32 degrees F or No. 0 below +32 degrees F; and lubricate breaker arm pivot, wick under rotor and governor weight pivots, and slots with 1 to 2 drops of OIL, engine, SAE 30 above +32 degrees F, SAE 10 from +32 degrees F to zero degree F and OIL, lubricating, preservative, light, below zero degree F.

(9) BRAKE CABLES. Every 6,000 miles, remove inner cables, clean, and coat lightly with GREASE, general purpose, No. 0. Do not fill housings.

(10) WHEEL BEARINGS. Remove bearing cone assemblies from hub, and wash spindle and inside of hub. Inspect bearing races, and replace, if necessary. Wet the spindle and inside of hub and hub cap with wheel bearing grease to a maximum thickness of  $\frac{1}{16}$  inch only to retard rust. Wash bearing cones and grease seals. Inspect and replace, if necessary. Lubricate bearings with wheel bearing grease with a packer or by hand, kneading lubricant into all spaces in the bearing. Use extreme care to protect bearings from dirt and immediately re-assemble and replace wheel. The lubricant in the bearings is sufficient to provide lubrication until the next service period. Any excess might result in leakage into the brake drum.

(11) OILCAN POINTS. Every 50 hours or 1,000 miles, lubricate caster hanger bearing, water pump drive chain, hand brake ratchet, linkage, tail gate hinges, hood hinges, and latches with OIL, engine, SAE 30 above +32 degrees F, SAE 10 from +32 degrees F to zero degree F and OIL, lubricating, preservative, light, below zero degree F.

(12) POINTS TO BE SERVICED AND/OR LUBRICATED BY ORDNANCE MAINTENANCE PERSONNEL. Generator and exciter shaft bearings, starter, distributor (disassembly only) (par. 19).

(13) POINTS REQUIRING NO LUBRICATION SERVICE. Springs, governor, flexible coupling.

### 19. POINTS TO BE SERVICED AND/OR LUBRICATED BY ORDNANCE MAINTENANCE PERSONNEL.

a. **Generator and Exciter Shaft Bearings.** Yearly, or whenever the generator and/or exciter is disassembled, remove, clean, and re-pack the bearings with GREASE, lubricating, special.

b. **Starter.** Whenever starter is disassembled, clean and coat bearings and seats with OIL, engine, SAE 10.

c. **Distributor.** Whenever distributor is disassembled, pack pockets in governor laminated weights with GREASE, general purpose, No. 1 above +32 degrees F and No. 0 below +32 degrees F.

### 20. REPORTS AND RECORDS.

a. **Reports.** If lubrication instructions are closely followed, proper lubricants used, and satisfactory results are not obtained, a report will

**TOOLS AND EQUIPMENT**

be made to the ordnance officer responsible for the maintenance of the materiel.

**b. Records.** A complete record of seasonal changes of lubricants will be kept in the Artillery Gun Book for the materiel.

**Section V**

**TOOLS AND EQUIPMENT**

	Paragraph
Introduction .....	21
Tools .....	22
Accessories .....	23
Fire extinguisher .....	24

**21. INTRODUCTION.**

**a.** The materiel described herein includes tools and equipment for general care, maintenance, and preservation. Accessories should not be used for purposes other than as prescribed and, when not in use, should be stored in the places or receptacles provided.

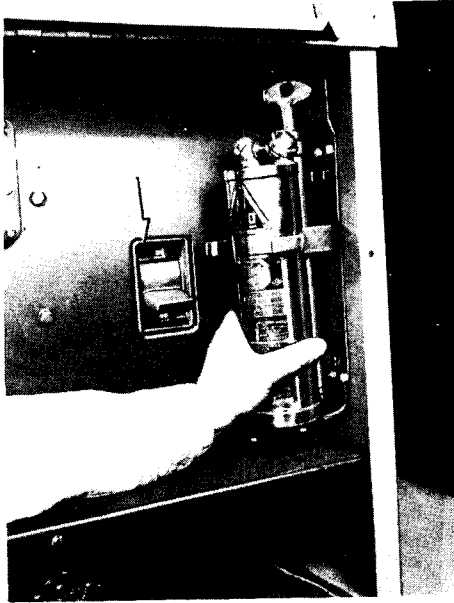
**22. TOOLS.**

**a. Service Tools Supplied with the Generating Unit.** These tools are carried in the tool box:

- Chisel, cold
- File, mill
- Hammer, ball peen
- Pliers, combination
- Punch, pin
- Screwdriver, 4-in. blade
- Screwdriver, 6-in. blade
- Screwdriver, offset
- Wrench, adjustable, 12-in.
- Wrench, and gage, distributor
- Wrench and handle, spark plug
- Wrench, double, open-end,  $\frac{3}{8}$  x  $\frac{7}{16}$  in.
- Wrench, double, open-end,  $\frac{1}{2}$  x  $\frac{9}{16}$  in.
- Wrench, double, open-end,  $\frac{5}{8}$  x  $\frac{9}{16}$  in.
- Wrench, double, open-end,  $\frac{5}{8}$  x  $\frac{3}{4}$  in.
- Wrench, double, open-end,  $\frac{7}{8}$  x  $1\frac{5}{16}$  in.
- Wrench, double, open-end,  $1\frac{5}{16}$  x  $1\frac{1}{16}$  in.
- Wrench, double, open-end,  $1\frac{1}{4}$  x  $1\frac{7}{16}$  in.
- Wrench, socket-head set screw,  $\frac{1}{8}$  in.
- Wrench, socket-head set screw,  $\frac{5}{32}$  in.
- Wrench, tappet (2)

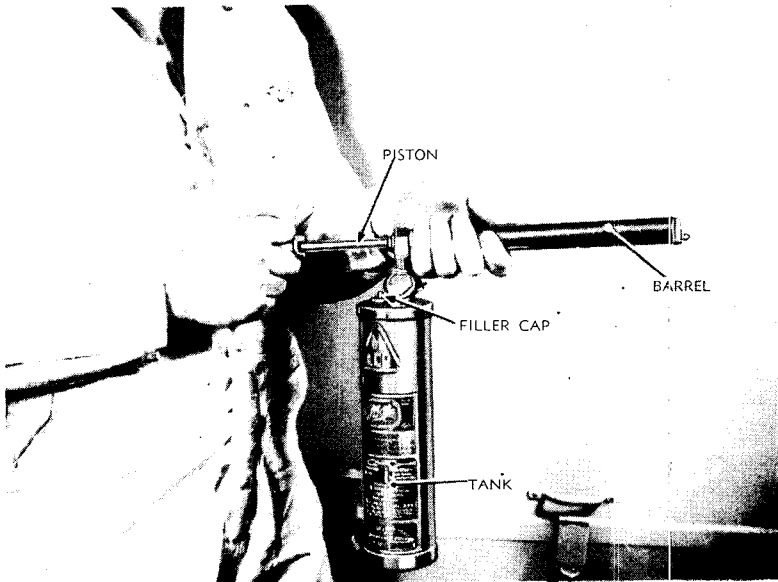


**GENERATING UNIT M7**



RA PD 56883

**Figure 14—Fire Extinguisher Removal**



RA PD 56884

**Figure 15—Fire Extinguisher in Use**

**OPERATION UNDER UNUSUAL CONDITIONS**

**23. ACCESSORIES.**

Accessories	Quantity	Where Carried
Crank	1	Left side panel
Cup, oil drain	1	Floor of trailer
Fire extinguisher, 1-quart	1	On instrument panel
Light, trouble, 6-volt	1	Tool box
Light, trouble, 125-volt	1	Tool box
Oilcan, 3-inch spout	1	Tool box
Padlocks, for trailer	2	Tool box

**24. FIRE EXTINGUISHER.**

**a. Location.** The fire extinguisher, filled with a CARBON TETRACHLORIDE solution, is located at the right of the instrument panel (fig. 14).

**b. Operation.** Lift latch on holding clip, and pull out pump. Hold plunger barrel in left hand, and let tank drop to right-angle position. Operate handle with right hand, first unlocking by a turn in either direction (fig. 15).

**c. Refilling.** Remove hexagonal filler cap, and fill to capacity. Replace cap.

**d. Maintenance.** At least once a year, the extinguisher should be partially discharged, and refilled. At this time, the pump piston should be removed, and the pump piston head inspected. If the leather is dry, apply and work in 1 or 2 drops of OIL, engine, SAE 10. To remove piston, take out round-head screw at top of barrel, and the piston can be pulled out.

**Section VI**

**OPERATION UNDER UNUSUAL CONDITIONS**

	Paragraph
Cold weather maintenance .....	25
Gasoline for low temperatures .....	26
Engine lubrication .....	27
Protection of cooling system .....	28
Protection of electrical system .....	29
General conditions .....	30
Starting and operation .....	31
Cold weather accessories .....	32
Extreme heat .....	33
Desert conditions .....	34
Flood conditions .....	35
Deep water fording .....	36

**GENERATING UNIT M7**

**25. COLD WEATHER MAINTENANCE.**

a. Operation and maintenance of the unit at low temperatures involve factors not found at normal operating temperatures, and operators must devote more time to protective maintenance. Failure to provide extra service will result in actual damage, unnecessary and unwarranted expense, and failure to start.

b. Low temperatures have been divided into two ranges: Zero degree F to —30 degrees F, and below —30 degrees F. Engines and lubricants undergo changes in their physical properties below —30 degrees F. In many cases, accessory equipment for supplying heat to engine, fuel, oil, and intake air is required.

**26. GASOLINE FOR LOW TEMPERATURES.**

a. **Selection.** Use the winter class of motor fuel procured under U. S. Army Specification 2-103, latest issue.

b. The formation of ice crystals from small quantities of water in the fuel sometimes causes considerable trouble. To keep water out of the fuel tank, observe the following precautions:

(1) Strain the gasoline through a suitable strainer. **CAUTION:** Be sure to provide a positive metallic contact between fuel container and gasoline tank, unless both fuel tank and container are independently grounded.

(2) In so far as possible, always keep the fuel tanks full. This will reduce condensation of water from the free air space above the fuel.

(3) Add ½ pint of denatured alcohol to a tank of gasoline. The alcohol will absorb the water and prevent it from freezing.

(4) Do not store fuel in old drums unless they have been thoroughly cleaned.

(5) Never pump fuel drums dry when filling vehicle fuel tanks; allow about 4 inches of fuel to remain. This residue can later be transferred to a settling tank. If time is not an urgent factor, do not pump fuel from drum to unit until it has settled for 16 hours after filling or moving the drum. Keep portable fuel pumps clean and protected from snow and frost.

(6) When a drum has been opened, be sure to cover the opening or replace the bung to keep out snow, frost, or other foreign matter. Store drums in a covered building or cover with a tarpaulin.

**27. ENGINE LUBRICATION.**

a. Engine lubrication at temperatures above zero degree F is covered in the Lubrication Guide. The following instructions supplement this information, and apply only to instances where the temperature falls below zero degree F for long periods.

b. Several methods of keeping engine oil sufficiently fluid for

**OPERATION UNDER UNUSUAL CONDITIONS**

proper lubrication at temperatures below zero degree F are listed below. Give preference to these methods in the order listed according to available facilities.

(1) Keep the unit in heated enclosure when not in operation.

(2) When engine is stopped, drain crankcase oil while it is hot, and store in a warm place until unit is to be operated again. If warm storage is not available, heat the oil before reinstalling. (Avoid overheating the oil; heat only to the point where the bare hand can be inserted without burning.) *Tag the Unit in a Conspicuous Place to Warn Personnel that Crankcase Is Empty.* Close shut-off valves to prevent flooding of the carburetor, and crankcase dilution because of the accumulation of gasoline vapor pressure in the gasoline tanks.

(3) If unit is to be kept outdoors, and if the oil cannot be drained, cover the engine with a tarpaulin. About 3 hours before engine is to be started, place fire pots under the tarpaulin. Use the Van Prag, Primus type, or other type blowtorch, or ordinary kerosene lanterns.

(4) Engine lubricating oil will be OIL, engine, SAE 10, diluted with gasoline or SOLVENT, dry-cleaning. Since the diluent will tend to evaporate when the oil becomes warm, the oil level may go down rapidly, and must be maintained by adding oil and diluent:

(5) The following procedure should be followed to provide the engine with properly diluted engine oil for cold starting.

(a) With the oil level at "FULL" mark and the engine warm, add a quantity of gasoline or dry-cleaning solvent, equal to 20 percent (one-fifth) of the normal crankcase capacity, for operation at zero degree F. With a 7-quart capacity crankcase add 1.4 quarts of diluent for zero degree F to minus 30 degrees F, or 2.1 quarts of diluent for below minus 30 degrees F.

(b) Run engine 5 to 10 minutes to mix oil and diluent thoroughly, and stop engine.

(c) After stopping, note level of crankcase oil on oil level gage stick. Level will be above normal "FULL" mark. It is advisable to mark this increased level on the gage for future reference.

**CAUTION:** Do not add diluent while engine is running. If any diluent is spilled on the engine, it must be wiped dry before starting.

(6) The following procedure should be used when operating the generator unit at sub-zero temperatures:

(a) At end of each operating period, check oil level.

(b) If oil level is below normal "FULL" mark, add necessary quantity of undiluted engine oil, SAE 10, to bring level to "FULL" mark. Then add the necessary quantity of gasoline or dry-cleaning solvent, to raise level to the mark recorded in step (5)(c), above. If oil level on stopping is at or above "FULL" mark, add enough gasoline or dry-cleaning solvent to bring level to mark recorded in step (5)(c), above.

## GENERATING UNIT M7

### 28. PROTECTION OF COOLING SYSTEM.

#### a. Antifreeze Solutions.

(1) In freezing weather, protect the cooling system by addition of an antifreeze solution, employing COMPOUND, antifreeze (ethylene glycol type).

(2) The table in paragraph 5 gives the approximate quantity of antifreeze necessary for various temperature conditions; however, check with an antifreeze solution hydrometer.

#### b. Precautions.

(1) Do not mix antifreeze solutions.

(2) Before installing antifreeze solution:

(a) Thoroughly flush the cooling system (par. 48).

(b) Check system for leaks; tighten hose connections, and replace if necessary; check thermostat and water pump. Make sure that the pump is properly lubricated.

(c) Check fan belt for adjustment or weakness. Do not use rubber fan belts at temperatures below minus 20 degrees F. Use leather, fiber, or synthetic rubber fan belts.

### 29. PROTECTION OF ELECTRICAL SYSTEM.

a. **Generator and Starter.** Inspect brushes, commutators, and bearings. See that the commutators are clean. Large surges of current, which occur when starting a cold motor, require good contact between brushes and commutators.

b. **Wiring.** Inspect and clean all connections, especially the battery terminals. Take care that no short circuits are present, or that there is no ice on the spark plugs, wiring, or other electrical equipment.

c. **Coil.** Check coil for proper functioning.

d. **Distributor.** Clean thoroughly, and clean or replace points. Check the points frequently. In cold weather, current is heavier, and the points may pit and burn more than usual.

e. **Spark Plugs.** Clean, test, and replace if necessary. If it is difficult to make the engine fire, reduce gap 0.005 inch more than that specified for normal operation. This will make sparking easier at the reduced voltages likely to prevail.

f. **Timing.** Check carefully. Take care that the spark is not unduly advanced or retarded.

#### g. Batteries.

(1) The efficiency of batteries decreases sharply with decreasing temperatures, and becomes practically nil at minus 40 degrees F. Do not attempt to start the engine with the battery when it has been exposed to temperatures below minus 30 degrees F, until the battery

### OPERATION UNDER UNUSUAL CONDITIONS

has been warmed. When operating in temperatures below zero degree F, it is best to remove the battery to a warm place, if the generating unit will not be used for a period of hours.

(2) A fully charged battery will not freeze at temperatures likely to be found even in arctic climates, while a fully discharged battery will freeze and rupture at approximately 18 degrees F. See that the battery is always fully charged with hydrometer reading between 1.275 and 1.300. If a hydrometer is not available, use ammeter and voltmeter to determine battery condition.

(a) Due to the action of the generator regulator, the ammeter reading at constant engine speed will be low when the battery is fully charged, and high when the battery is weak or discharged. To obtain an indication of battery condition, frequently check ammeter readings at approximately equal engine speeds.

(b) Voltmeter readings, taken at intervals with the same load on the battery, will provide a clue to potential battery performance.

(3) Maintain electrolyte level  $\frac{3}{8}$  inch above top of plates. If necessary to add distilled water, wait until the engine and battery have warmed up. Keep ventholes in filler plugs open. Keep terminals tight and clean. At regular intervals, apply a coating of GREASE, general purpose, No. 0, or COMPOUND, rust-preventive, light.

### 30. GENERAL CONDITIONS.

a. Make sure that no heavy grease or dirt has been left on the starter throw-out mechanism. Heavy grease or dirt may keep the gears from being meshed, or cause them to remain in mesh after the engine starts and thus ruin the starter.

b. Pull the choke control all the way out to secure the air-fuel ratio required for cold weather starting. Make sure the butterfly valve in the carburetor closes all the way and otherwise functions properly.

c. Carburetors, which give no appreciable trouble at normal temperatures, may not operate satisfactorily at low temperatures. A fuel pump, which will deliver enough gasoline at normal starting speeds of 400 rpm, may have leaky valves or a diaphragm which will prevent it from delivering a sufficient quantity of fuel at cranking speeds of 30 to 60 rpm. Another source of trouble is the float needle valve which, although a close fit, must move freely. Different expansions of the metals used in the needle valve parts may cause the needle valve to stick at extremely low temperatures.

d. At temperatures below zero degree F, do not use oil in air cleaners. The oil will congeal and prevent easy flow of air. At temperatures below minus 30 degrees F, remove the air cleaners. Ice and frost formations on the air cleaner screens may cause an abnormally high intake vacuum and an overrich mixture.

**GENERATING UNIT M7**

e. Inspect the unit frequently. Shock resistance of metals, or resistance against breaking, is greatly reduced at extremely low temperatures. Movement of units on hard, frozen ground causes strain and jolting which will loosen or break bolts and nuts.

f. Remove or bypass oil filters at temperatures below minus 30 degrees F, because the viscous oil will not flow freely through them.

g. Remove and clean gasoline strainer at frequent intervals.

**31. STARTING AND OPERATION.****a. Temperatures from Zero Degree F to Minus 30 Degrees F.**

(1) It is possible to start gasoline engines with batteries at temperatures as low as minus 30 degrees F, if the engines are properly lubricated and in good mechanical condition.

(2) To insure that the engine will start on the first attempt, proper preparation of the engine is very important. Should the engine fire a few times and stop, water vapor, which is a product of combustion, may form frost in the combustion chamber, and make it impossible to start without heating the engine to above 32 degrees F. Prolonged starting efforts wear down the battery. It is well to give the engine a few turns with the hand crank before turning on the ignition.

(3) Pull the choke lever all the way out for starting, and keep it partially pulled out until the engine has warmed up. Since only the lightest components of the gasoline vaporize in a cold engine, a very rich mixture is necessary.

(4) When attempting to start, turn the engine over as rapidly as possible. All engines have a critical cranking speed, that is, the engine must be turned over at a certain rate of speed before any start at all is possible. For engines in good mechanical condition, this critical rate of speed may vary from 40 to 70 rpm.

(5) After the engine is started, idle it at 800 to 1,000 rpm until it has warmed up enough to run smoothly. Do not place the unit in operation until its minimum operating temperature of 160 degrees F has been reached.

(6) When exercising generator units, they must be run for at least 30 minutes, and preferably for 1 hour under load. Shorter operating periods will inevitably cause the formation of moisture in the crankcase. This moisture then combines with carbon and dirt to form sludge in the crankcase which may cause bearing failures. Also the moisture will freeze and prevent circulation of oil. During these exercising periods, the radiator should be covered to give rapid warm-up, and to maintain engine and oil temperatures at normal values. After stopping, all covers should be kept in place to hold engine temperature as high as possible during the shut-down period.

## OPERATION UNDER UNUSUAL CONDITIONS

### b. Temperatures Below Minus 30 Degrees F.

(1) Cover engine with tarpaulin, tent, or portable shed. Place oil stoves, fire pots, or four or five ordinary kerosene lanterns under the covering about 3 hours prior to starting time.

(2) Keep unit in sheltered area, shielded from wind. Cold winds increase starting difficulties.

(3) Ice may collect in the fuel line. If the engine does not appear to be getting enough fuel, heat the fuel line lightly, *but be alert for fires.*

## 32. COLD WEATHER ACCESSORIES.

a. A number of the most commonly used accessories have been mentioned in the preceding sections. These, together with other accessories and attachments used successfully in northern climates, are listed below. The use of these accessories is not mandatory. They are given only as suggestions, and are to be used at the discretion of officers in charge of the materiel.

(1) Tarpaulins, tents, or collapsible sheds are useful for covering the unit.

(2) Fire pots (Primus type) or Van Prag blowtorches, ordinary blowtorches, oil stoves, or kerosene lanterns can be used for heating unit.

(3) Extra batteries and facilities for changing batteries quickly help in starting.

(4) Steel drums and suitable metal stands are useful for heating crankcase oil.

(5) Insulation for the fuel line helps prevent ice formation inside the line.

(6) Radiator covers, improvised locally, help keep the engine running at normal temperatures. In very cold weather, the radiator doors may be left closed while the engine is started. When the engine is warmed up, the doors may be adjusted in the position that experiment will prove most satisfactory.

## 33. EXTREME HEAT.

a. **Doors.** When operating in very hot climates, it is extremely important to maintain correct engine temperature. Radiator doors, of course, will be left open, and, while the engine is running, the instrument panel door shall be open. The other doors may experimentally be opened and closed, until the desired engine temperature is obtained. It will probably be found that closing all the canopy doors will create the best direct air circulating condition, with the air drawn by the action of the fan up through the frame, across the engine, and out through the radiator.



**GENERATING UNIT M7**

**b. Battery.** The specific gravity and temperature of the battery electrolyte should be maintained. In hot climates, batteries tend to self-discharge, if they are not in use.

**c. Fuel Tank.** The humidity that often accompanies extreme heat creates condensation on metal. For this reason, it is best to keep the fuel tank filled to capacity at all times. Considerable water from condensation will collect in the tank if it is allowed to remain partially empty. Water may be drained from the tank through the drain cock provided.

**d. Ignition System.** In humid atmospheres, spark plugs, ignition coil, distributor, and wire and cable terminals should be frequently wiped dry of condensation moisture.

**34. DESERT CONDITIONS.**

**a. General.** When operating in regions which approximate conditions found in a desert, the care necessary for hot climates and also precautions against sand are required. To guard against dust and sand storms, protective breaks and coverings should be rigged. All operating parts should be cleaned constantly. The utmost care should be taken to keep particles of sand and grit out of the engine, generator, exciter, instruments, etc.

**b. Fuel System.** The fuel tank cover should be kept tight at all times. The top of the cap shall be frequently taken off and the vent slots cleaned. The fuel filter must be cleaned frequently, and, if necessary, the fuel lines blown out. The air filter element must be given constant attention to ensure a regular air flow.

**c. Lubrication System.** The oil filler cap must be kept tight and the bayonet-type oil gage must be kept firmly in place. The oil filter should be cleaned often, with an air hose or by scraping the element, and by draining at the sludge plug in the filter base.

**35. FLOOD CONDITIONS.**

**a. General.** During periods of continual rainfall, and when operating in flooded regions, the principal chances for trouble lie in the generating and ignition systems. While the unit is in operation, the heat of the engine will tend to keep dry the sources of potential trouble. When the unit is not operating, it should be given every protection possible to keep water and moisture from collecting inside the canopy. Doors must be kept closed at all times and, if possible, tarpaulins or other protective coverings shall be used outside the canopy. Before starting, the generating and ignition systems and all terminals and connections should be wiped dry.

**b. Generator and Exciter.** Before starting, the generator and exciter should be dried out as thoroughly as possible. Exciter belts, pulleys, and shafts must be wiped dry. If necessary, the bell housing

## OPERATION UNDER UNUSUAL CONDITIONS

guard must be removed, and all parts within reach wiped dry. Generator and exciter brushes must be wiped dry.

**c. Ignition System.** Practically all parts of the ignition system can be damaged by water. Spark plugs should be removed and carefully dried. The distributor leads must be disconnected and dried, and all parts of the distributor must be thoroughly dried. Battery leads, ignition coil leads, and all other wiring must be dried prior to starting. The instrument panel should be wiped dry, and all connections at the rear should be inspected and dried, if necessary.

### 36. DEEP WATER FORDING.

#### a. General.

(1) These instructions are designed to protect the generating units against complete immersion during deep water fording operations or surf landings, and still permit immediate use of the units after landing. They will serve as a general guide for supplementing supervision of actual waterproofing by trained personnel. Only the significant points are covered in the detailed instructions.

(2) Necessity for extreme care in all steps cannot be overemphasized. Every seam, joint, or opening must be completely sealed. When waterproofing is completed, the units should be carefully inspected to make sure all openings and parts have been properly treated.

#### b. Servicing Prior to Waterproofing.

(1) Clean housing thoroughly.

(2) Lubricate all points ordinarily lubricated, daily, and after 8-, 50-, and 200-hour operations, in accordance with the lubrication instructions in section IV of this manual.

(3) Tighten bolts and nuts in all covers and openings, such as electric receptacle bodies, housing screws, etc.

(4) Remove all oil and grease from points to which waterproofing compound or materials are to be applied.

#### c. Waterproofing (Units Mounted in Trailers).

(1) Cut wood blocks to fit between skids at both front and rear of unit. Drive these blocks in the openings between the unit and the trailer floor. Seal the openings around these blocks with asbestos grease.

(2) Drive wood pegs in holes in floor of trailer, and seal with asbestos grease.

(3) Close all doors, and seal edges with waterproofing tape. Close and seal radiator doors with waterproof tape.

(4) Cover all seams and cracks in unit with tape, and seal all bolts with asbestos grease.

(5) Cover electric brake breakaway switch with asbestos grease.

**GENERATING UNIT M7**

Disconnect the chain during travel in water. Remove electric brake cable, and seal cable socket with asbestos grease. Disconnect brakes during travel in water.

(6) Seal gas tank filler opening and gas gage with waterproof tape. Seal all cracks around gas tank cover with asbestos grease.

(7) Seal all junction boxes and cable connections on trailer and in trailer side compartments with asbestos grease.

(8) Screw power receptacles tight, and seal with asbestos grease.

(9) Place exhaust cover on pipe, and seal with asbestos grease.

(10) Seal lenses and all cracks around guide. Remove and seal all stop lamps with asbestos grease.

**d. Waterproofing (Units Mounted on Skids).** Use the same procedure as directed for units mounted in trailer (subpar. c, above) with the following exceptions:

(1) Drive wood blocks in between unit and floor of the truck which is carrying the unit.

(2) Apply a heavy coat of asbestos grease to all contact points between unit and truck floor, so the joints will remain sealed, despite small movement caused by uneven terrain.

**e. Material Required.**

**GREASE**, asbestos . . . . . 7½ lbs

Substitutes are **GREASE**, water pump, and **COMPOUND**, rust-preventive, heavy.

**TAPE**, adhesive, non-hygroscopic, 6 in. wide, 4 in. wide . . . . . ½ roll

**SOLVENT**, dry-cleaning . . . . . As required

**f. Preparation for Operating Unit.**

(1) **IMMEDIATE ACTION.**

(a) Remove all waterproofing material from doors, and open doors.

(b) Clean all electric receptacles and plugs to insure good connection.

(c) Start gasoline engine, allow engine to warm up, and check for normal operation.

(d) Connect cables in normal manner, and check main generator output.

(2) **COMPLETE DEWATERPROOFING AS SOON AS TIME AND FACILITIES ALLOW.**

(a) Remove all waterproofing material.

(b) Clean the asbestos grease from all the surfaces with **SOLVENT**, dry-cleaning.

(c) Remove wheels, clean and relubricate wheel bearings.

(d) Clean and lubricate, in accordance with the lubrication instructions in section IV of this manual, all points to be covered at all intervals.

## PART TWO—ORGANIZATIONAL MAINTENANCE INSTRUCTIONS

### Section VII MAINTENANCE ALLOCATION

	Paragraph
Scope .....	37
Allocation of maintenance .....	38

#### 37. SCOPE.

a. The scope of maintenance and repair by the crew and other units of the using arms is determined by the availability of suitable tools, availability of necessary parts, capabilities of the mechanics, time available, and the tactical situation. All of these are variable and no exact system of procedure can be prescribed.

#### 38. ALLOCATION OF MAINTENANCE.

a. The outline below assigns specifically to each echelon its duties and functions in the proper care and maintenance of the generating unit. All echelons of maintenance should be capable of performing all lower echelons of maintenance. Maintenance in the field is necessarily a flexible matter. In a combat zone, where there is immediate danger of enemy attack, the organizational specialist, if qualified, would be perfectly correct in performing emergency third echelon repairs if no maintenance company is available. When, under field conditions, both the using arms and the ordnance maintenance troops must use their discretion as to how best to accomplish their maintenance mission. However, extreme care must be exercised if a lower echelon attempts the work of a higher one. Attempts at repair work that belong in higher echelons of maintenance may result in damage to the materiel.

##### b. Echelons are Defined as Follows:

(1) **FIRST ECHELON.** This consists of the personnel actually using the materiel (e. g., the gun crew). Proper care of the materiel, cleaning, lubrication, and a limited number of minor repairs are performed by this echelon. Preventive maintenance is the keynote here.

(2) **SECOND ECHELON.** This consists of the maintenance personnel in the company, battalion, regiment, or corresponding units in the using arm or services, and it performs limited unit replacement, lubrication, and minor repairs.

(3) **THIRD ECHELON.** Maintenance is normally performed by ordnance medium maintenance or antiaircraft maintenance companies using standard issue mobile equipment. Some activities of this echelon are replacement of unit assemblies, overhaul of accessory unit assem-

**GENERATING UNIT M7**

blies and subassemblies, recovery of materiel, and evacuation. This maintenance is performed by ordnance personnel of ordnance medium maintenance units for the organizations they serve. The supply of spare parts to lower echelons is also a function of these medium maintenance companies.

(4) **FOURTH ECHELON.** Normally consists of ordnance heavy maintenance companies or post ordnance shops (other than base shops) having facilities for performing major disassemblies and heavy maintenance.

(5) **FIFTH ECHELON.** Normally consists of personnel of arsenals and authorized base shops with facilities for performing complete overhaul.

**c. Maintenance Allocations.****(1) FIRST ECHELON.**

Maintain oil level in crankcase.

Maintain gas in tank.

Maintain air pressure in tires, and make tire repairs.

Maintain battery water level.

Maintain radiator water level.

Adjust louvers for proper operating temperature.

Renew fuze links.

Clean gasoline pump sediment bowl.

Replace lamps.

**(2) SECOND ECHELON.**

Grease, oil, and lubricate.

Clean or replace air and oil filters.

Adjust "rate of charge" of battery-charging generator.

Adjust engine governor.

Clean and adjust distributor points.

Clean and flush radiator and cooling system.

Repack water pump.

Adjust or replace fan or generator belts.

Clean spark plugs, and adjust gaps.

Adjust or replace exciter belts.

Replace battery.

Check and tighten all electrical terminals.

Adjust oil pump pressure.

Adjust spring tension, or replace brushes on starter motor, battery-charging generator, exciter, and/or alternator.

Replace the following engine and generator accessories:

Spark plugs and ignition wiring.

Spark coil.

Intake and exhaust manifolds.

## MAINTENANCE ALLOCATION

Fan assembly.  
Starter.  
Starter bendix spring.  
Battery-charging generator.  
Battery-charging voltage regulator generator.  
Water-cooling system hose.  
Water-cooling system thermostat.  
Water pump.  
Oil gage.  
Oil lines and fittings.  
Oil strainer.  
Battery cables.  
Lighting switch.  
Starting switch.  
Tachometer.  
Muffler.  
Exhaust pipe.  
Carburetor.  
Throttle box.  
Distributor rotor.  
Condenser.  
Distributor points.  
Ammeter.  
Battery-charging ammeter.  
Fuel pump.  
Fuel gage.  
Light receptacles.  
Field rheostat.  
Switches.  
Throttle control.  
Choke control.

### (3) THIRD AND FOURTH ECHELONS.

General repair, including valve grinding, carburetor repair, distributor repairs and adjustments, etc., but not including rebores, piston, bearing, or rod work.

Replace electrical or mechanical parts or assemblies.

Replace wheels, repair brakes, etc., on Generator Trailer M7.

### (4) FIFTH ECHELON.

Perform all necessary repairs or replacements which cannot properly be done by lower echelons.

**GENERATING UNIT M7**

**Section VIII**

**FRAME**

	Paragraph
Description .....	39
Trouble shooting .....	40
Maintenance .....	41

**39. DESCRIPTION.**

a. **Construction.** The base frame is of all-welded steel construction. Seven-inch steel channels, running the length of the unit, are the main members. Bolting holes allow the maximum clearance for proper alinement of the components of the unit.

b. **Functioning.** The frame brings engine, generator, accessories, and canopy together as a complete, self-contained unit to be set upon and affixed to the trailer floor or to the wood skids.

**40. TROUBLE SHOOTING.**

a. Any change of alinement of the frame members, due to shock or undue strain, will be almost certain to throw the generating unit out of alinement, and cause great damage when the unit is put into operation. After any shock to the frame through accident or other cause, frame alinement should be carefully checked.

**41. MAINTENANCE.**

a. As the frame members are welded together, with no loose parts or accessories, maintenance is merely a matter of inspection to make sure the welds are holding securely, and that shocks have not been severe enough to throw the frame out of alinement.

**Section IX**

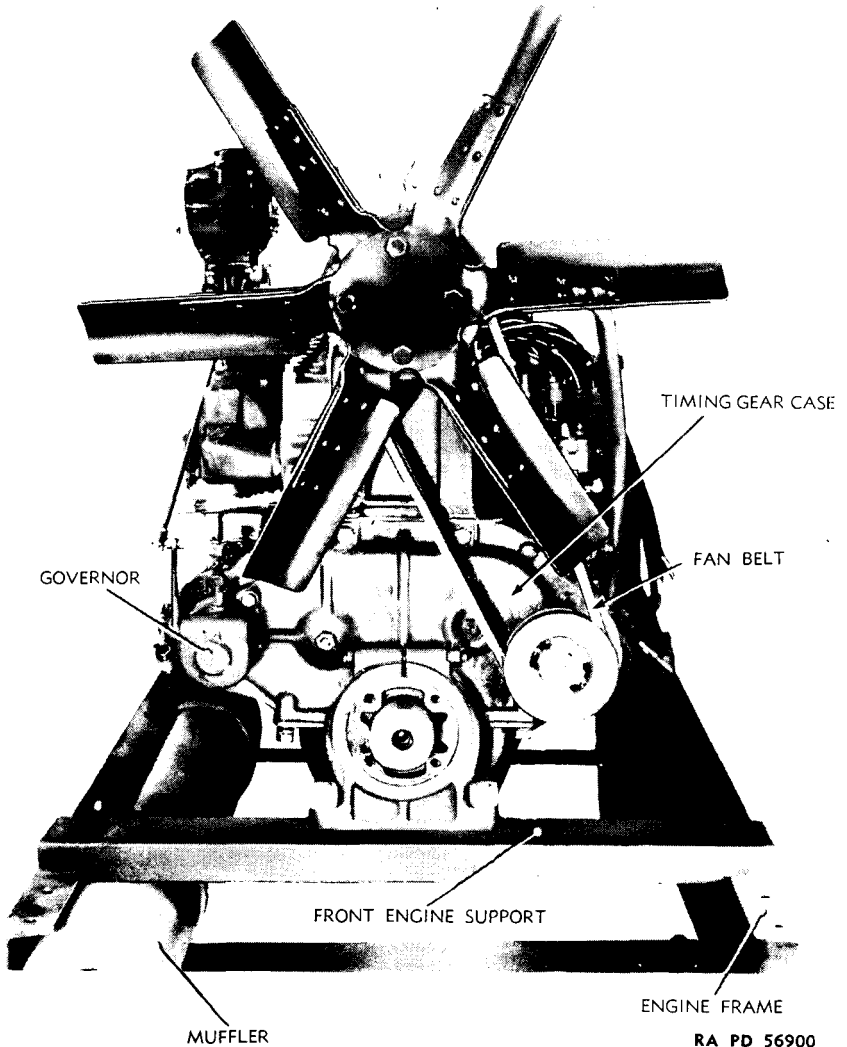
**ENGINE**

	Paragraph
Description .....	42
Trouble shooting .....	43
Maintenance .....	44
Tune-up .....	45

**42. DESCRIPTION.**

a. **Construction.** The gasoline engine (figs. 16, 17 and 18) is a 6-cylinder, L-head type, with aluminum pistons. The cylinder block and crankcase are cast in one piece, and the water jacket extends the

ENGINE



RA PD 56900

**Figure 16—Engine—With Radiator and Canopy Removed—  
Front View**

full length of the cylinder bore. The cylinder head is made of cast iron, and is easily removable to permit service operations.

**b. Accessories.**

(1) **WATER PUMP.** The water pump is attached to the left side of the engine block on the accessory drive (fig. 17).

(2) **FUEL PUMP.** The fuel pump is on the right side of the engine, back of the exhaust pipe (fig. 41).



GENERATING UNIT M7

- A — BAYONET OIL GAGE
- B — OIL FILTER SLUDGE PLUG
- C — WATER PUMP DRIVE COUPLING
- D — ACCESSORY DRIVE
- E — TACHOMETER DRIVE
- F — OIL FILLER CAP
- G — DISTRIBUTOR
- H — RADIATOR
- J — THERMOSTAT HOUSING
- K — OIL FILTER
- L — CARBURETOR
- M — AIR FILTER
- N — IGNITION COIL
- P — BYPASS PIPE
- Q — TACHOMETER DRIVE SHAFT
- R — ENGINE NAMEPLATE
- S — WATER PUMP
- T — STARTING MOTOR

RA PD 56901

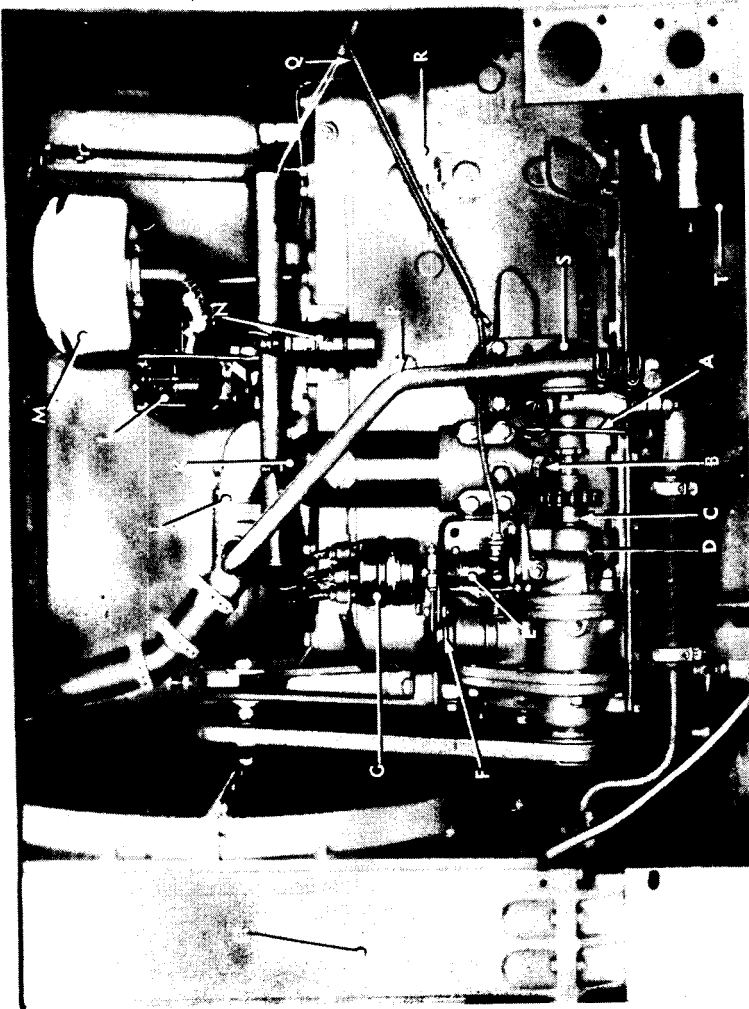


Figure 17—Engine—Left Side

ENGINE

- A — VALVE COVER
- B — CRANKCASE BREATHER TUBE
- C — INTAKE MANIFOLD
- D — EXHAUST MANIFOLD
- E — BATTERY CHARGING GENERATOR
- F — GOVERNOR
- G — THROTTLE BOX
- H — MANIFOLD LEVER
- J — GOVERNOR LINKAGE
- K — 2-CHARGE REGULATOR

RA PD 84539

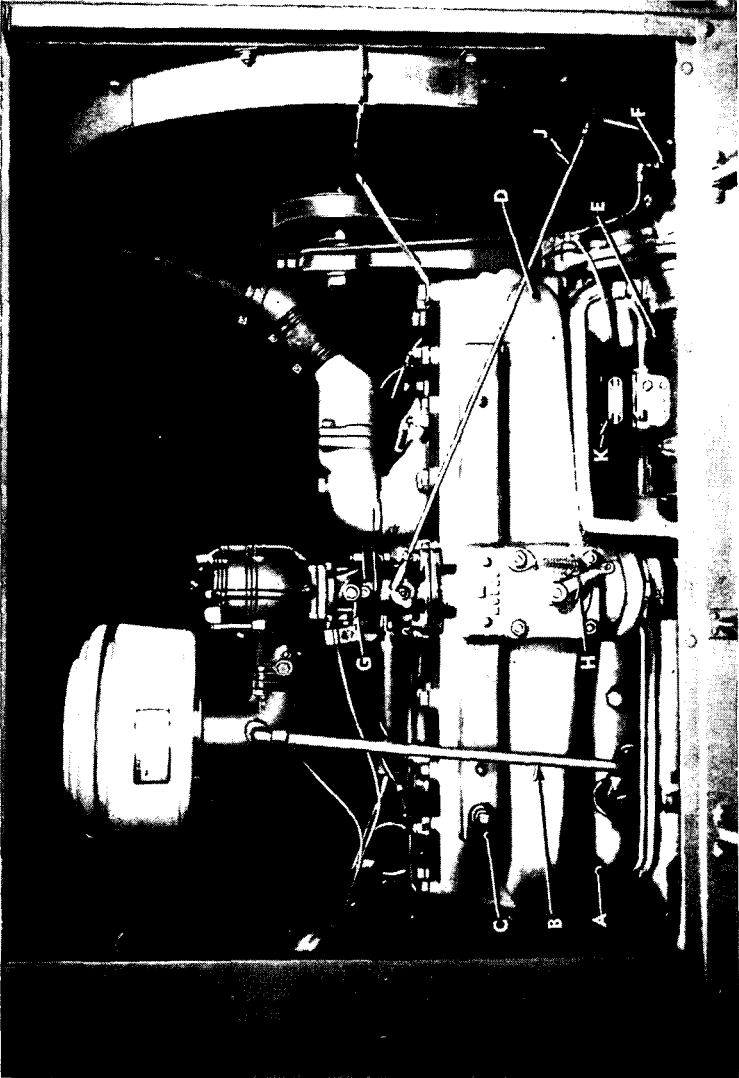


Figure 18 — Engine — Right Side

**GENERATING UNIT M7**

(3) **MANIFOLD.** The combination exhaust and intake manifold is on the right side of the engine block (fig. 18).

(4) **MUFFLER.** The muffler is strapped to the frame at the right of the engine (fig. 35).

(5) **OIL FILTER.** The oil filter is on the left side of the engine, above the accessory drive (fig. 17).

(6) **THERMOSTAT.** The thermostat is in the water outlet line to the radiator on top of the engine (fig. 30).

(7) **THROTTLE BOX.** The throttle box is mounted on the intake section of the manifold at right of engine (fig. 18).

(8) **CARBURETOR.** The carburetor is mounted on the throttle box at right of engine (fig. 45).

(9) **AIR FILTER.** The air filter is mounted on the carburetor elbow above the manifold (fig. 46).

(10) **BATTERY-CHARGING GENERATOR.** The battery-charging generator is located under the manifold at the right side of engine (fig. 61).

(11) **GOVERNOR.** The governor is at the right side of the engine, in front of the battery-charging generator (fig. 61).

(12) **TACHOMETER DRIVE.** The tachometer drive is mounted on a flange above the accessory drive on the left side of the engine (fig. 17).

(13) **DISTRIBUTOR.** The distributor is mounted on the tachometer drive on the left side of engine (fig. 17).

(14) **IGNITION COIL.** The ignition coil is mounted on a bracket held down by an engine cylinder cap screw head on the left side of engine (fig. 17).

(15) **STARTING MOTOR.** The starting motor is at the left of the engine block mounted on the bell housing (fig. 17).

**c. Functioning.** The engine is of the internal combustion, 4-stroke cycle, automotive type. Fuel is drawn into the fuel pump from the fuel tank, and then forced through to the carburetor to be mixed with the right quantity of air. The mixture goes into the intake section of the manifold, where it is drawn into each cylinder at the proper time by the down, or intake, stroke of the piston. It is then compressed by the upward, or compression, stroke, and ignited by a spark as the piston reaches the top point of travel. The expansion of the burning gases forces the piston down for the power stroke. Before the piston reaches bottom, the exhaust valve opens, and as the piston returns in the exhaust stroke, it forces the burned gases through, into the exhaust section of the manifold, and out by way of the muffler. The complete cycle of four piston strokes results in two revolutions of the crankshaft. Successive firing in the six cylinders results in a steady impelling force on the crankshaft.

**ENGINE**

**d. Specifications.**

Make .....	Hercules gasoline
Model .....	WXLC-3
Type .....	L-head
Number of cylinders .....	6
Bore .....	4¼ in.
Stroke .....	4¾ in.
Piston displacement' .....	404 cu. in.
Compression ratio .....	6.35 to 1
Firing order .....	1-5-3-6-2-4
Maximum horsepower at rated speed .....	67 hp at 1,200 rpm
Crankcase capacity .....	7 qt
Cooling system capacity .....	36 qt
Weight (with accessories) .....	945 lb

**43. TROUBLE SHOOTING.**

**a. Engine Fails To Start.**

Possible Cause	Possible Remedy
Lack of fuel.	Supply fuel.
Clogged fuel line.	Clean fuel line.
No spark.	Check distributor points, condenser, and ignition coil.

**b. Engine Stops.**

Too heavy load on cold engine.	Remove load, and warm up engine.
Lack of fuel.	Supply fuel.
Clogged fuel line.	Clean fuel line.
Fuel leak.	Check fuel line.
No spark.	Check distributor points, condenser, and ignition coil.

**c. Engine Runs Irregularly or Misfires.**

Dirt or water in fuel line.	Clean fuel line, strainer, and sediment cup.
Cylinder or cylinders not firing.	Replace spark plugs.
Spark plugs defective.	
Too rich mixture.	Adjust idling speed mixture adjusting screw.
Manifold air leak.	Replace gasket or manifold.
Faulty governor adjustment.	Adjust governor.

**d. Overheating.**

Clogged oil line.	Clean out oil line.
Thermostat stuck closed.	Service, or replace thermostat.

**e. Popping, Spitting, or Spark Knock.**

Excessive carbon deposits.	Report to ordnance personnel.
Spark plug gaps too wide.	Close gaps to 0.025 inch.
Dirt on spark plug porcelain.	Wipe clean.

GENERATING UNIT M7

f. Poor Compression.

Possible Cause	Possible Remedy
Loose spark plugs.	Tighten plugs in head, or replace.
Cylinder head loose.	Tighten head.
Cylinder head gasket leaking.	Report to ordnance personnel.

g. Lack of Power.

Low or poor compression.	See step f, above.
Air cleaner restricted.	Clean mesh element.
Overheating. Thermostat stuck closed.	Service, or replace.
Improper mixture.	Adjust carburetor screw.

44. MAINTENANCE.

a. **Inspection and Adjustments.** Section III covers general inspections which include the engine. Under "Trouble Shooting," paragraph 43, are given specific checks for various sorts of engine faults.

45. TUNE-UP.

a. Procedure.

(1) One of the most important operations in the maintenance of the engine is proper engine tune-up. This operation, more than any other, determines whether or not the engine delivers the maximum in performance and economy. Only by accurately making the following checks and adjustments can the maximum performance of the engine be obtained.

(2) COMPRESSION.

(a) Before making any checks on the engine, it should be run for several minutes to warm it up, and lubricate the valve mechanism. The compression of the engine should be checked first when tuning, because an engine with uneven compression cannot be tuned successfully.

(b) Remove all spark plugs. The ignition should be turned off, with the governor throttle valve in the "OPEN" position.

(c) Insert the compression gage in a spark plug hole, and hold it tightly. Crank the engine with the starting motor until the gage reaches its highest reading, which requires only a few turns. Repeat the same test on all cylinders, and make a note of the compression on each.

(d) The compression on all cylinders should be 110 pounds per square inch or better, and all cylinders should read approximately the same, within 5 to 10 pounds, for satisfactory engine performance.

(e) Should one or more cylinders register low compression readings, notify ordnance maintenance, as a mechanical defect has developed beyond the using arms scope of repair.

**ENGINE**

(3) **SPARK PLUGS.** Remove, clean, and adjust all spark plugs (par. 79).

(4) **BATTERY TEST.**

(a) Connect the negative terminal of a voltmeter to the starting switch terminal, and the positive terminal of the voltmeter to a good ground.

(b) Rotate the engine with the starting motor for 15 seconds. If the starting motor turns the engine over at a good rate of speed with the voltmeter reading 5 volts or better, it indicates a satisfactory starting circuit, which includes the condition of the battery, terminals, and cables. However, if it turns over slowly, or the voltmeter reading is under 5 volts, the starting motor, battery, and battery cable terminals should be checked individually to locate the source of the trouble (sec. XIV).

(5) **DISTRIBUTOR.**

(a) Remove the spark plug wires from the distributor cap, and examine the terminals for corrosion. The wires should also be checked for damaged insulation and for being oil-soaked.

(b) Remove the distributor cap, and check the cap and distributor rotor for cracks or burned contacts.

(c) Check the automatic advance mechanism, by turning the distributor cam in a clockwise direction as far as possible, and releasing the cam to see if the springs return it to its retarded position. If the cam does not return readily, report to ordnance personnel.

(d) Examine the distributor points. Dirty points should be cleaned, and pitted or worn points should be replaced. Check the points for alinement, and aline them, if necessary.

(e) Hand crank the engine until cam follower rests on a peak of the cam. Adjust the point gap to between 0.019 and 0.021 inch, using feeler gage. This operation must be performed very accurately. Hand crank engine until the cam follower is located between the cam peaks. Hook the end of a point scale over the movable point, and pull steadily on the spring scale until the points just start to open. Correct spring tension is between 18 and 21 ounces.

(f) Install distributor cap and spark plug wires. Make sure that the terminals of the primary wire from the ignition coil to the distributor are clean and tight.

(6) **FUEL PUMP.** Remove the sediment cup and screen and wash them thoroughly in SOLVENT, dry-cleaning. When assembling, make sure that the cork gasket is in good condition, and properly seated. Tighten all fuel pump connections.

(7) **AIR FILTER.**

(a) Remove the air filter from the carburetor. Remove the wing nut from the top of the filter and take off the cover.

GENERATING UNIT M7



**Figure 19—Timing Hole in Engine Bell Housing**

(b) Empty the oil out of the filter, and clean out all oil and accumulated dirt. Wash body with SOLVENT, dry-cleaning and wipe dry. Wash filter element by slushing up and down in SOLVENT, dry-cleaning. Dry thoroughly, either with an air hose or by letting it stand until dry. Fill the body of the filter to bend level with OIL, engine (seasonal grade).

(c) Install the filter on the carburetor elbow. Tighten clamp.

(8) CARBURETOR. The only carburetor adjustment that should be attempted by using arms is with the idling speed mixture adjusting screw. This controls the fuel mixture to the engine while the engine is operating at idle speed only (fig. 45).

(9) IGNITION TIMING. NOTE: Timing should be checked under the supervision of ordnance personnel. Attach one wire of the neon timing light to No. 1 spark plug, and the other wire to the No. 1 spark plug wire. Start the engine and run it at idling speed. Loosen distributor clamp and slightly rotate distributor body clockwise or counterclockwise until the entire white dot on the flywheel (fig. 19) is visible through the timing hole in the flywheel housing each time the light goes on.

(10) COOLING SYSTEM. Tighten all hose connections, and examine for any indications of water leaks. Check the fan and exciter belts for cracks, oil soaking, and for proper tension.

**Section X**  
**COOLING SYSTEM**

	<b>Paragraph</b>
Description .....	46
Trouble shooting .....	47
Cleaning .....	48
Radiator .....	49
Fan .....	50
Fan belt .....	51
Water pump .....	52
Thermostat .....	53

**46. DESCRIPTION (fig. 20).**

a. **Construction.** The water-cooling system consists of the radiator (fig. 22), thermostat (fig. 30), fan assembly, centrifugal water pump, and the connecting lines and hose. The water capacity is 36 quarts. The system may be drained by opening a drain cock located in the water outlet pipe connected to the bottom of the radiator (fig. 21). The fill cap is in the usual position at the top of the radiator.

b. **Functioning.** The pump circulates cooled water from the bottom of the radiator through the channels in the water jacket and cylinder head. The water heated in the water jacket is forced through the radiator inlet into the upper radiator tank, flows down the radiator tubes for cooling, and is redrawn into the pump to complete the cycle. Air, drawn through louvers and up through the frame, passes across the engine, and is forced out of the unit through the radiator fins by the action of the fan, thereby cooling the water. On the top of the engine, at the point where the water returns to the radiator, is a thermostat whose function is to keep cool water from entering the radiator, by forcing it to return directly to the pump through the bypass tube until the engine is warmed up.

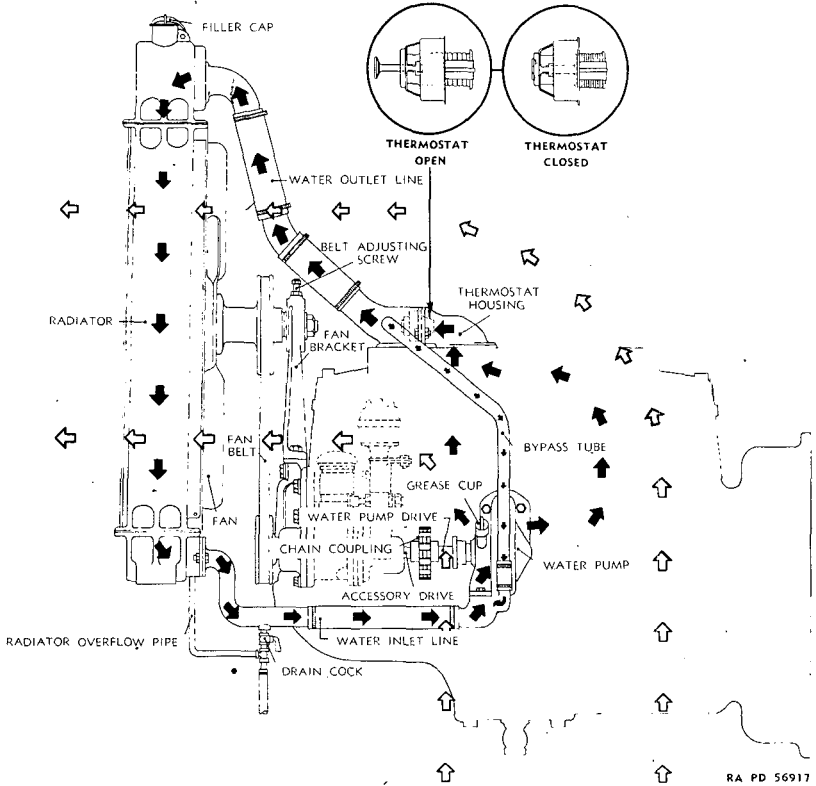
**47. TROUBLE SHOOTING.**

a. **Overheating.**

<b>Possible Cause</b>	<b>Possible Remedy</b>
Leaks in system.	Service or replace faulty hose, clips, gaskets, or pipe.
Radiator dirty inside or out.	Clean radiator thoroughly.
Dirty water.	Drain, and refill with clean water.
Clogged system.	Flush system, from top of engine down.
Clogged radiator.	Service, or report to ordnance personnel for replacement.
Leaky radiator.	Report to ordnance personnel.
Thermostat stuck closed.	Service, or replace.



**GENERATING UNIT M7**



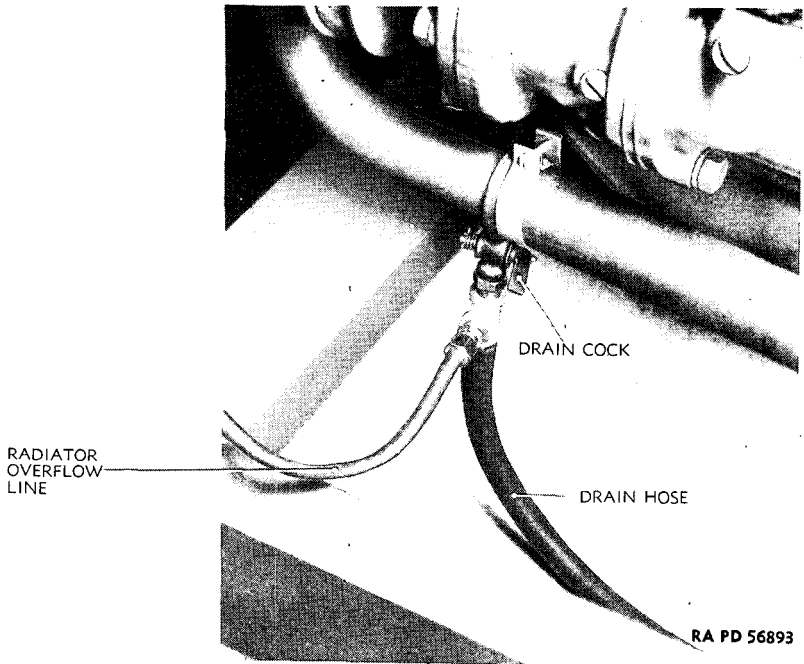
**Figure 20—Cooling System Diagram**

Possible Cause	Possible Remedy
Loose fan belt.	Adjust.
Broken fan belt.	Replace.
Pump does not function.	Report to ordnance personnel.
<b>b. Overcooling.</b>	
Thermostat stuck open.	Service, or replace.

**48. CLEANING.**

**a. General.** The cooling system should be cleaned at least twice a year. It should be cleaned before the COMPOUND, antifreeze (ethylene glycol type) is put into the system, and again after it is removed. If the cooling system is very dirty or clogged, so that overheating occurs, ordnance personnel should be notified. The entire system should be examined for leaks both before and after cleaning and flushing. The cleaning solution should never be mixed with anti-freeze solutions or inhibitors.

## COOLING SYSTEM



**Figure 21—Radiator Drain Line**

### **b. Cleaning.**

(1) Run the engine until the temperature is within operating range. Stop the engine, remove the radiator cap, and drain the system by opening the drain cock. If necessary, use a wire to keep the drain hole open if it tends to become clogged. Coolants containing ethylene glycol must be saved or discarded as outlined in W.D. Circular 137, V, 16 June 1943.

(2) Allow the engine to cool. Close the drain cocks, start the engine at idling speed, and start immediately to pour water slowly into the radiator, until it is nearly full. Add the Compound, cleaning (federal stock no. 51-C-1568-500) in the proportion of one container of cleaner to every 4 gallons of cooling system capacity. Then fill the system with water. Never mix the water and the cleaning compound before putting them into the system.

(3) Place a clean drain pan to collect overflow, and use it to maintain the level in the radiator when necessary.

(4) Replace the radiator cap and run the engine at moderate speed, covering the radiator if necessary, until the coolant reaches a

**GENERATING UNIT M7**

temperature above 180 degrees F but not over 200 degrees F. Do not allow the level in the radiator to drop low enough to interfere with the circulation.

(5) Stop the engine after it has run for 30 minutes within the 180-degrees F to 200-degrees F range. Then, remove the radiator cap, and drain the system completely.

**c. Neutralizing.**

(1) Allow the engine to cool. Close the drain cock, run the engine at idling speed, and commence immediately to pour water slowly into the radiator. Pour until it is nearly full. Add the neutralizer compound (federal stock no. 51-C-1568-500) in the proportion of one container of neutralizer to every 4 gallons of cooling system capacity. Then fill the system with water.

(2) With the radiator covered, run the engine for at least 5 minutes at operating temperature. Then stop the engine.

(3) Drain the system completely by removing the radiator cap and opening the drain cock.

**d. Flushing.**

(1) Allow the engine to cool. Close the drain cock, start the engine, and fill the system with water immediately.

(2) Run the engine until the coolant is heated to operating temperature.

(3) Drain the system by removing the radiator cap and opening the drain cock. Repeat the flushing operation until the drain water is clean.

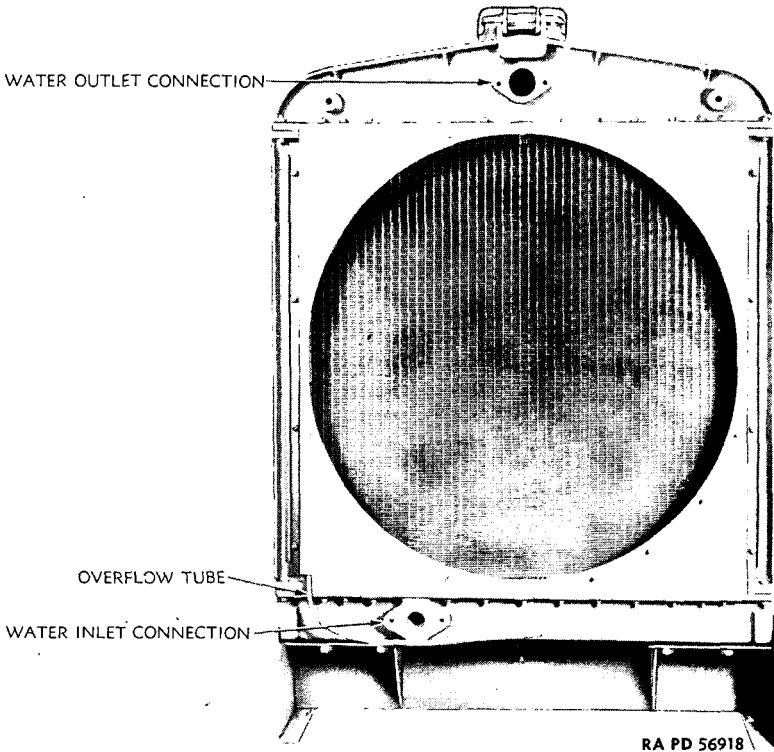
(4) Clean all sediment from the radiator cap valves and the overflow pipe. Blow insects and dirt from radiator core air passages with compressed air, blowing from the rear. Use water, if necessary, to soften obstructions.

**e. Leaks.** After completing flushing operation and before pouring appropriate coolant into cooling system, allow engine to cool. Start the engine, and immediately fill the system with coolant. Stop the engine when the cooling system is completely full. Then examine the entire cooling system for leaks. The cleaning solution often uncovers leaks which already exist but are plugged with rust or corrosion.

**f. Coolant Service.**

(1) When servicing the vehicle for summer, nearly fill the system with clean water. Add Compound, inhibitor, corrosion (federal stock no. 51-C-1600) in the proportion of one container of inhibitor to each 4 gallons of cooling system capacity. Then fill the system with water.

## COOLING SYSTEM



RA PD 56918

**Figure 22—Radiator and Support—Rear View**

(2) When servicing for winter, fill the system about one-quarter full of clean water. Add sufficient COMPOUND, antifreeze (ethylene glycol type) for protection against the lowest temperature likely to be encountered. Nearly fill the system with water, and run the engine until normal operating temperature is reached. Then add sufficient water to fill the system to the proper height (par. 28).

### 49. RADIATOR (fig. 22).

a. **Description.** The radiator is of the 3-piece, heavy-duty tractor type, and is mounted on the frame in front of the engine where it acts as front support for the canopy roof.

#### b. Trouble Shooting.

##### (1) OVERHEATING.

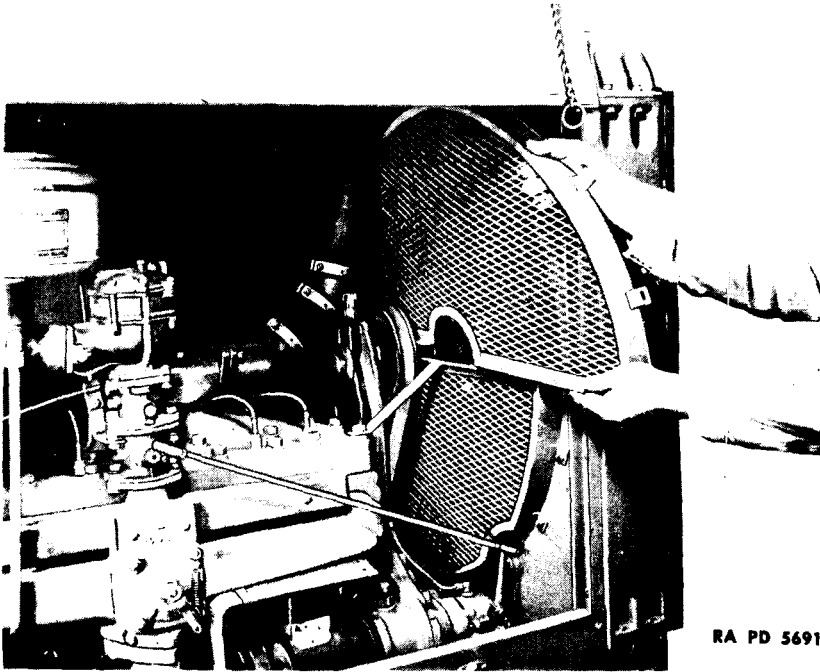
###### Possible Cause

Leaky radiator.  
Clogged radiator.  
Radiator dirty, inside or out.

###### Possible Remedy

Report to ordnance personnel.  
Clean, or report to ordnance personnel for replacement.  
Clean radiator.

GENERATING UNIT M7



RA PD 56919

**Figure 23—Fan Guard Removal**

c. **Maintenance.** Radiator and all connections should be frequently inspected for leaks.

**50. FAN.**

a. **Description.** The fan assembly is made up of the fan, the fan shaft, a pulley, and an adjustable mounting bracket. The fan belt is  $\frac{7}{8}$  inch wide, and 54 inches long.

**b. Trouble Shooting.**

(1) **FAN STOPS.**

Possible Cause

Broken belt.

(2) **BELT SLIPS.**

Loose belt.

(3) **EXCESSIVE NOISE.**

Defective bearing.

Possible Remedy

Replace.

Tighten with lifting screw.

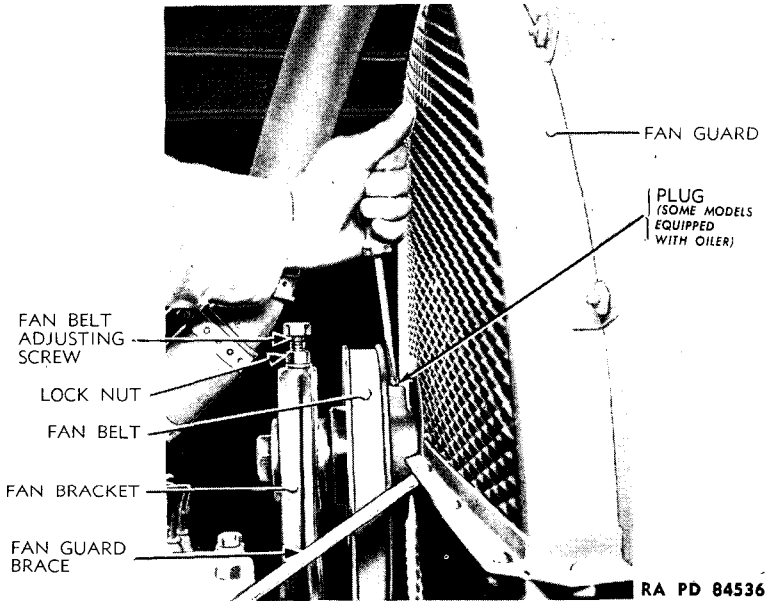
Replace fan assembly.

c. **Maintenance.** The fan does not need special attention. Screws should be kept tight, and the whole assembly kept clean and properly lubricated (fig. 24).

**d. Removal.**

(1) **REMOVE FAN BELT FROM PULLEY.** Loosen lock nut on

**COOLING SYSTEM**



**Figure 24—Fan Hub Screw Plug Grease Fitting**

mounting bracket screw. Turn screw until fan belt is loose enough to be slipped off top pulley.

(2) **REMOVE FAN GUARD** (fig. 23). Take out screws, nuts, and lock washers holding the two sections of the guard together. Take off nuts and lock washers attaching the two guard sections to the shroud, and lift out guard.

(3) **REMOVE FAN AND BRACKET**. Take out base cap screws and lock washers holding bracket to engine, and lift off fan assembly.

**e. Installation.**

(1) **ATTACH FAN AND BRACKET**. Attach fan bracket to engine with cap screws provided.

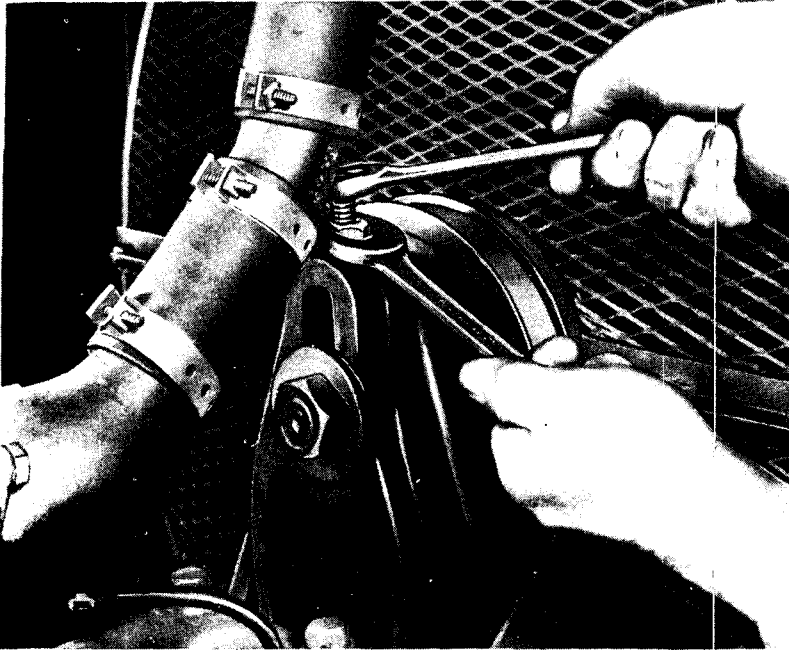
(2) **INSTALL FAN BELT**. Bring fan belt up over fan onto fan pulley (fig. 26), then onto pulley at end of accessory drive. Turn adjusting screw (fig. 25) until the amount the fan belt can be deflected at a center point between pulleys measures from  $\frac{1}{2}$  to  $\frac{3}{4}$  inch. Tighten lock nut against bracket.

(3) **ATTACH FAN GUARD**. Place guard sections in position, and secure to fan shroud with lock washers and nuts on the projecting bolts. Fasten sections together with machine screws, lock washers, and square nuts.

**51. FAN BELT.**

**a. General.** For best results, the fan belt should be kept free of

GENERATING UNIT M7



RA PD 56920

**Figure 25—Adjusting Fan Belt**

dirt, grease, and oil. Its adjustment should be checked frequently. Fan belt is properly adjusted when it can be deflected from  $\frac{1}{2}$  to  $\frac{3}{4}$  inch at a center point between pulleys (fig. 25).

**b. Removal.**

- (1) REMOVE FAN BELT FROM PULLEY (par. 50 d (1)).
- (2) REMOVE FAN GUARD (par. 50 d (2)).
- (3) REMOVE BELT. Take belt off lower pulley, and remove it by bringing it down over fan.

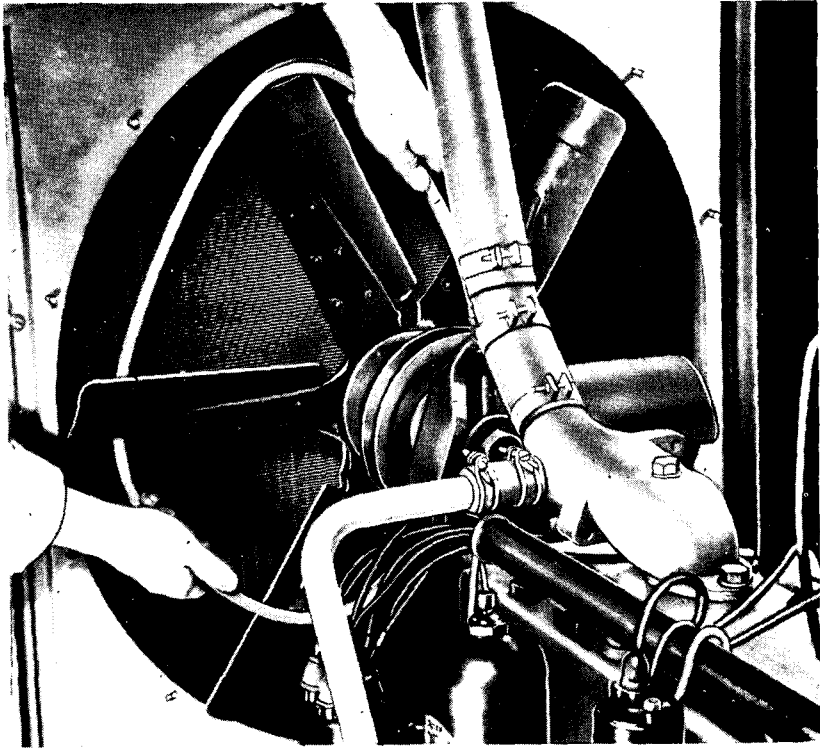
**c. Installation.** For instructions on installing fan belt, see paragraph 50 e, (2) and (3).

**52. WATER PUMP.**

**a. Construction.** The centrifugal water pump is mounted on the left side of the engine. It is driven by the accessory drive to which it is attached by a chain coupling. Four packing rings (split-ring type), tightened by a packing nut against a gland, seal the water pump at the shaft end.

**b. Functioning.** The impelling force of the water pump circulates the cooled water from the bottom of the radiator through the entire cooling system (fig. 20).

## COOLING SYSTEM



RA PD 56952

**Figure 26—Fan Belt Installation**

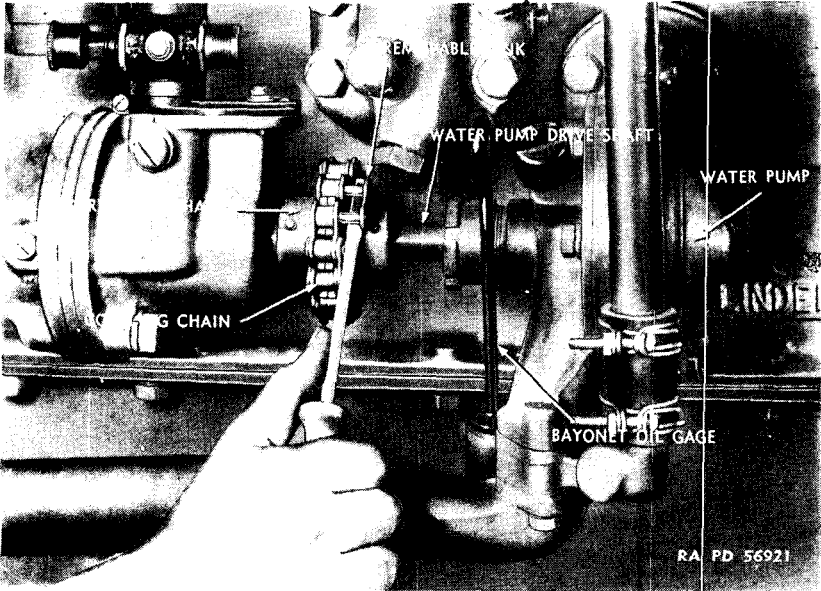
c. **Maintenance.** The water pump should be lubricated as specified in section IV. A leak developing at the water pump packing nut can be stopped by tightening the nut; however, care must be taken not to tighten the nut with considerable force. Water pump must be repacked if packing nut is turned up its full thread and leaking continues. New packing will not stop the leak at the shaft if the shaft is worn. The pump must be replaced. Any other trouble with the water pump necessitates replacement of the complete unit.

**d. Repacking.**

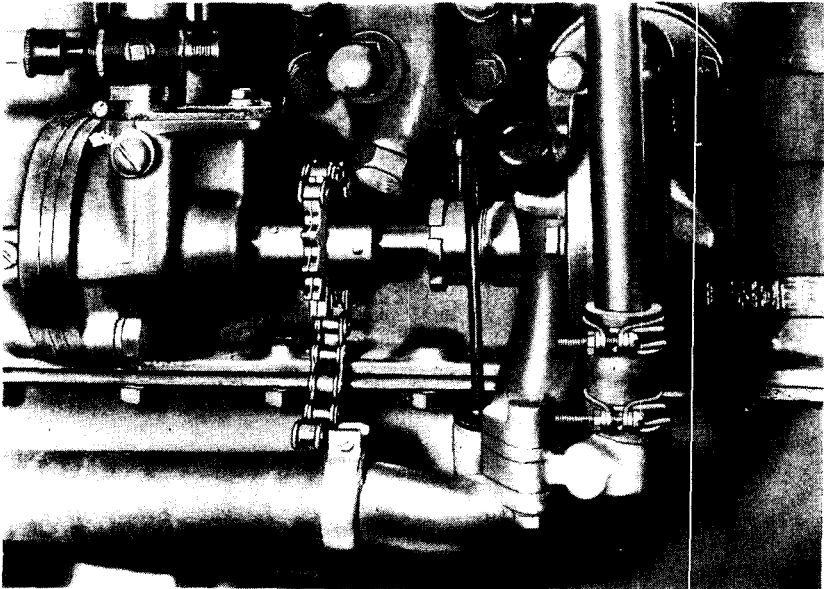
- (1) Drain cooling system.
- (2) Unscrew packing nut, pry out packing gland, and remove old packing. The four packing rings are removed by prying them out of the housing.
- (3) Place a new split-ring packing on the shaft, and, using the packing gland, push it into the pump housing. Continue this procedure until four packing rings are inserted in the pump housing.
- (4) Push packing gland into position over packing in pump hous-



GENERATING UNIT M7



**Figure 27—Removing Link from Accessory Drive Water Pump Shaft Coupling Chain**



**Figure 28—Accessory Drive Chain Coupling Removal**

## COOLING SYSTEM

ing, and screw packing nut over gland onto pump body. Do not tighten nut with any considerable force.

(5) Refill cooling system, start engine, and check for a leak at the pump. If a leak exists, tighten packing nut while engine is running.

### e. Removal.

(1) DRAIN COOLING SYSTEM (par. 53 c(1)).

(2) REMOVE WATER PUMP ELBOW. Loosen clamp screw holding hose section to water pump elbow. Take out cap screws fitting water pump elbow to water pump.

(3) REMOVE BYPASS PIPE. Loosen clamp screws holding top and bottom hose sections to bypass pipe, and remove pipe.

(4) SEPARATE CONNECTION WITH ACCESSORY DRIVE. Separate coupling chain attaching pump drive to accessory drive by forcing out removable link (figs. 27 and 28).

(5) REMOVE PUMP. Take out cap screws and lock washers holding water pump and gasket to engine block.

### f. Installation.

(1) INSTALL PUMP. Attach pump and gasket in position on side of engine block with the three cap screws and lock washers provided.

(2) CONNECT WITH ACCESSORY DRIVE. Bring coupling chain around coupling sections, and lock in place by inserting removable link.

(3) INSTALL BYPASS PIPE. Connect top of bypass pipe to thermostat housing with the rubber hose. Tighten clamp screws, connect bottom of bypass pipe to the water pump connection by the hose section, and tighten clamp screws.

(4) INSTALL WATER PUMP ELBOW. Insert pipe end of elbow in rubber hose in bottom water line. Bring flanged end to water pump, and install cap screws and lock washers provided. Tighten strap screw holding hose to pipe.

## 53. THERMOSTAT.

a. Construction. The thermostat is a plug-type, temperature-relief fitting, set in a split elbow housing in the upper radiator line to the engine.

b. Functioning. Until the water in the engine reaches a temperature of 150 degrees F, the thermostat keeps this water from circulating through the radiator, thus decreasing the "warming up" period. At 150 degrees F, the thermostat begins to open; at 180 degrees F it is fully open. While the thermostat is closed, the water circulated through the engine by the pump is shunted off through the bypass line back to the pump.

GENERATING UNIT M7

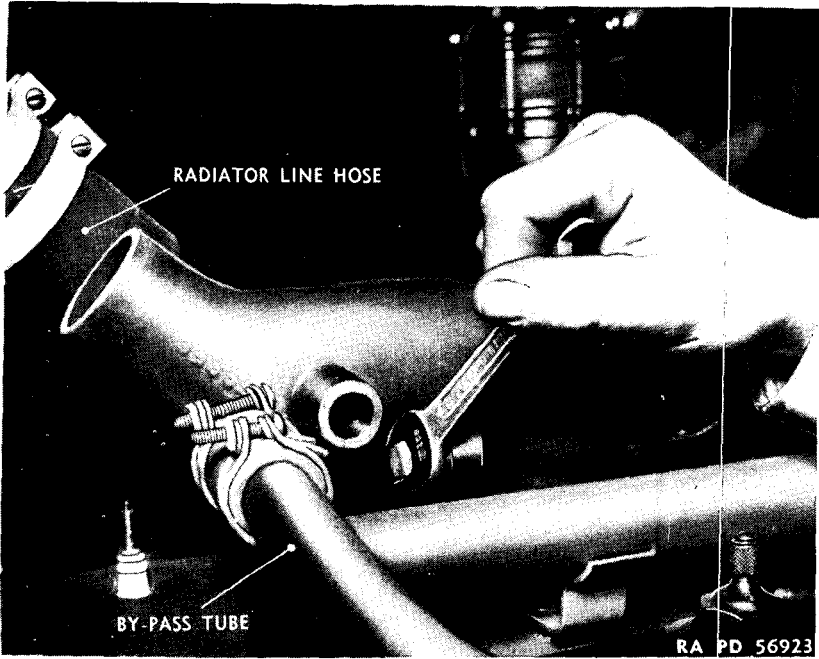


Figure 29—Taking Apart Thermostat Housing

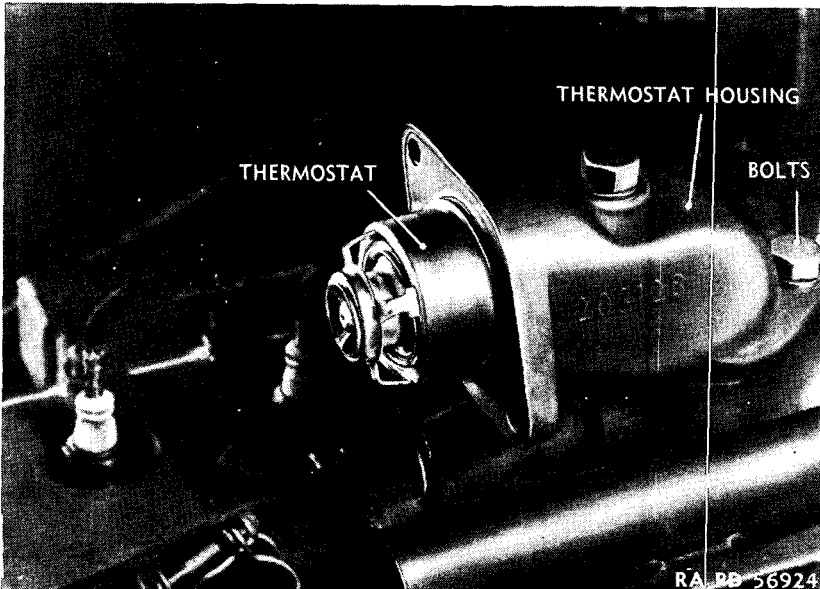


Figure 30—Thermostat—Section of Housing Removed

**EXHAUST SYSTEM**

**c. Removal.**

(1) **DRAIN WATER LINES.** Open drain cock in radiator outlet pipe (fig. 21). This will drain engine, radiator, and water lines.

(2) **DISCONNECT BYPASS PIPE.** Loosen screws on wire clamps holding hose to thermostat housing, and disconnect bypass pipe.

(3) **SEPARATE RADIATOR CONNECTION TO THERMOSTAT HOUSING.** Loosen screws holding clamps on hose, and remove hose.

(4) **SEPARATE THERMOSTAT HOUSING** (fig. 29). Take out the cap screws and lock washers through the flanges of the thermostat housing. The thermostat may now be removed from the free half of the housing (fig. 30).

**d. Maintenance.** The thermostat is entirely enclosed, and ordinarily needs no attention. To find out if the thermostat is functioning properly, place it with a thermometer in a pan of water, and begin to heat the water. The thermostat should begin to open when the thermometer indicates 150 degrees F, and should be fully opened at 180 degrees F.

**e. Installation.**

(1) **INSTALL THERMOSTAT IN HOUSING.** Insert thermostat in the half of thermostat housing closest to the radiator, in the flanged end, with the coil showing.

(2) **CONNECT HOUSING WITH WATER LINES AND BRING SECTIONS TOGETHER.** Insert small end of free section of thermostat housing into rubber hose connecting to top of radiator, and bring flanged ends of housing halves together, first putting gasket in place. Bolt together with cap screws and lock washers. Tighten bolt on strap holding hose to thermostat housing. Bring hose at end of bypass line over nipple on thermostat housing, and tighten clamp bolt.

**Section XI**

**EXHAUST SYSTEM**

	Paragraph
Description .....	54
Trouble shooting .....	55
Manifold .....	56
Exhaust pipe .....	57
Muffler .....	58
Flexible tube .....	59

**54. DESCRIPTION.**

**a. Construction.** The exhaust system (fig. 31) is made up of the exhaust section of the manifold, the pipe connection between muffler and manifold, the muffler (fig. 36), and the flexible tube that is attached to the outside end of the muffler when the unit is in operation.

GENERATING UNIT M7

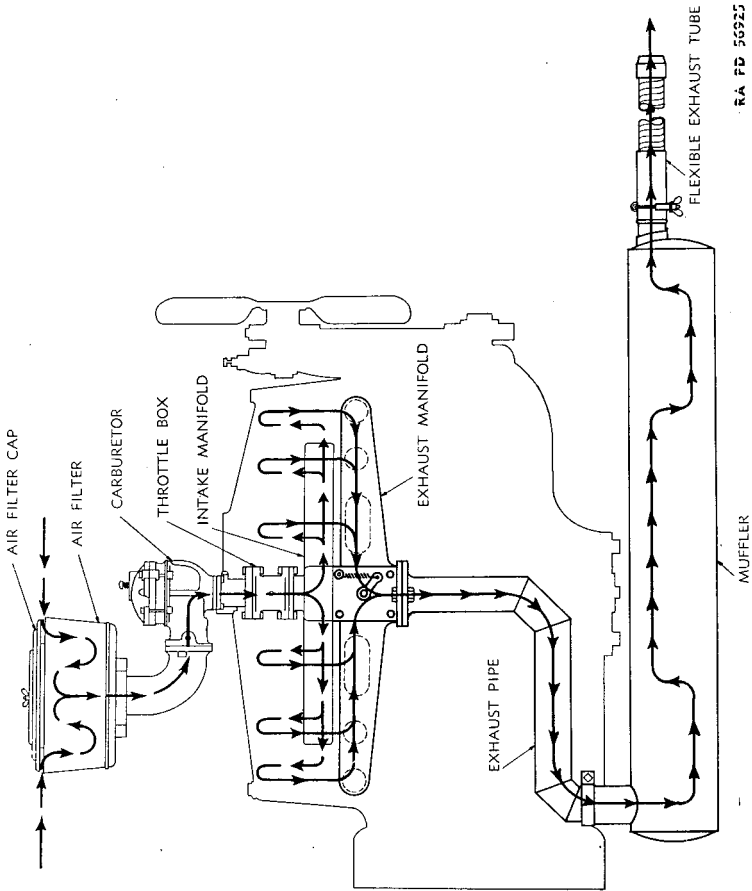


Figure 31—Intake and Exhaust System Diagram (Broken Arrows, Intake Air—Solid Arrows, Exhaust Gas)

## EXHAUST SYSTEM

**b. Functioning.** The burned gases resulting from the ignition of the mixture of gasoline and air in the cylinders are forced by the exhaust stroke of the pistons out of the cylinders, into the manifold, and away from the unit by way of the exhaust pipe, the muffler, and the exhaust tube.

### 55. TROUBLE SHOOTING.

#### a. Popping, Spitting, Spark Knock.

Possible Cause	Possible Remedy
Manifold heat control defective.	Adjust (under supervision).

#### b. Exhaust Fumes.

Leaking manifold gasket.	Tighten or replace.
Blown-out manifold gasket.	Replace.
Burnt-out muffler.	Replace muffler.

#### c. Excessive Noise.

Crack between intake and exhaust manifolds.	Replace manifold.
Burnt-out muffler.	Replace muffler.

### 56. MANIFOLD.

**a. Description.** The intake and exhaust manifold, along the right-hand side of the engine block, is of 1-piece construction. The top section is the intake, where the mixture of gasoline and air enters the cylinders. Preheating of the mixture is accomplished by an opening that allows the hot exhaust gases to strike the intake manifold wall. The size of this opening can be adjusted by a lever on the face of the manifold (fig. 32). A spring holds this lever in its correct position, and the setting should not be changed except by permission of higher authority.

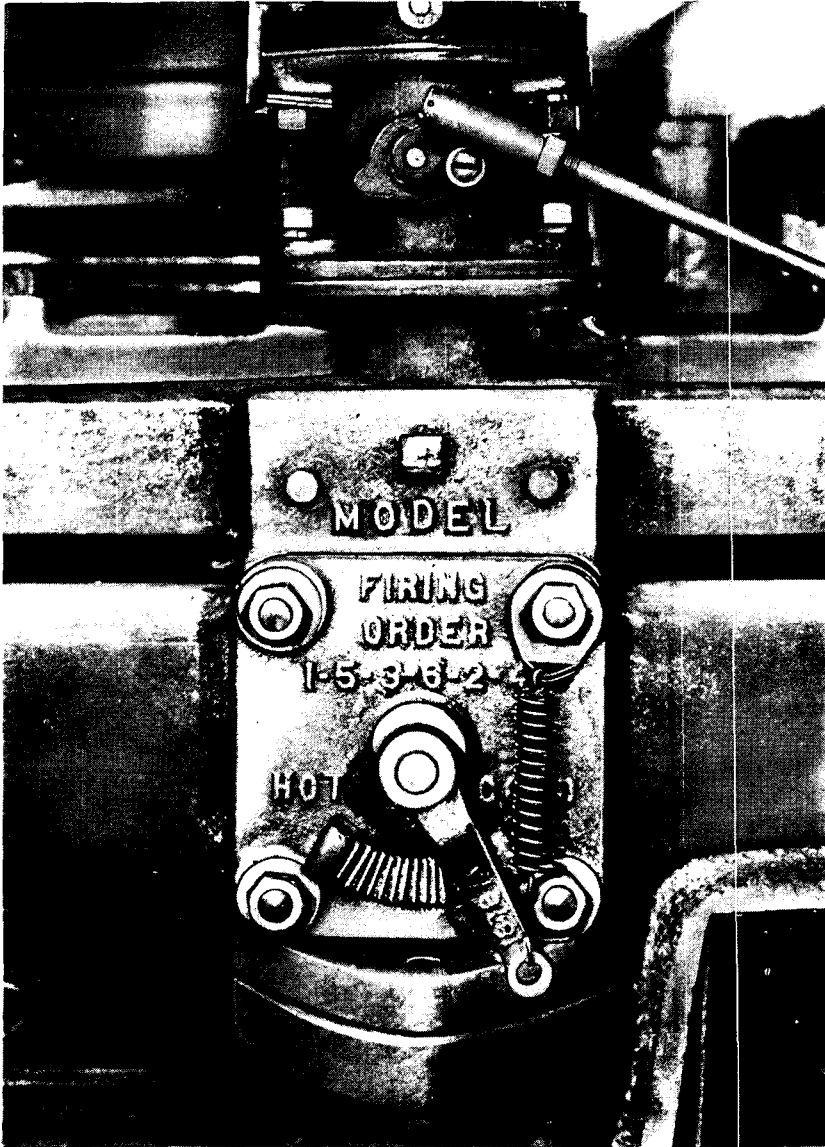
**b. Maintenance.** The manifold should be frequently inspected for cracks. When engine troubles develop that might have been caused by manifold cracks which are not apparent, the manifold should be taken off and thoroughly inspected. Check bolts for tightness. Check collar gasket. When replacing, use new gasket. Thoroughly scrape off old gasket.

#### c. Removal.

(1) **LOOSEN CHARGING GENERATOR** (fig. 62). Loosen lock nut on set screw holding charging generator. Loosen set screw, and turn charging generator until the regulator at top is at right angles to its former position. Tighten lock nut.

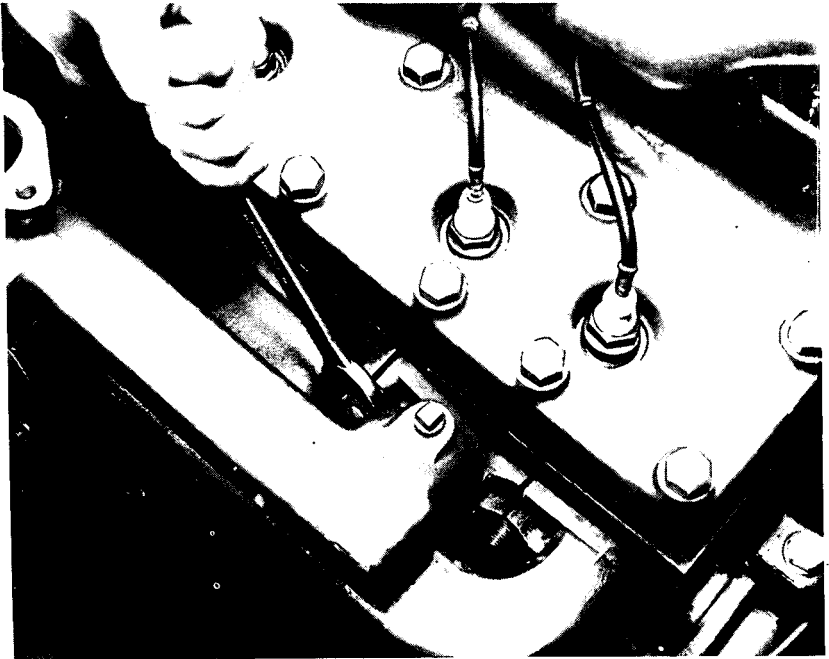
(2) **REMOVING CHARGING GENERATOR GUARD** (fig. 63). Take out cap screws holding asbestos lined charging generator guard in place, and remove guard.

GENERATING UNIT M7



RA PD 56926

*Figure 32—Manifold Lever and Holding Spring*

**EXHAUST SYSTEM**

RA PD 56927

**Figure 33—Manifold Removal**

(3) **DISCONNECT BREATHER PIPE.** Take out cap screw and lock washer holding breather pipe connection to valve cover.

(4) **UNCOUPLE GOVERNOR LINKAGE ROD.** Take off nut fastening governor linkage rod to governor arm. *Do not disconnect at the throttle box.*

(5) **REMOVE CARBURETOR AND THROTTLE BOX.** Take out the two cap screws and lock washer holding the throttle box to the manifold flange, and remove carburetor, throttle box, and air cleaner as one unit.

(6) **LOOSEN EXHAUST PIPE FROM MANIFOLD.** Take out the three cap screws and lock washers holding together the two lower manifold flanges. Loosen lock bolt through manifold flange.

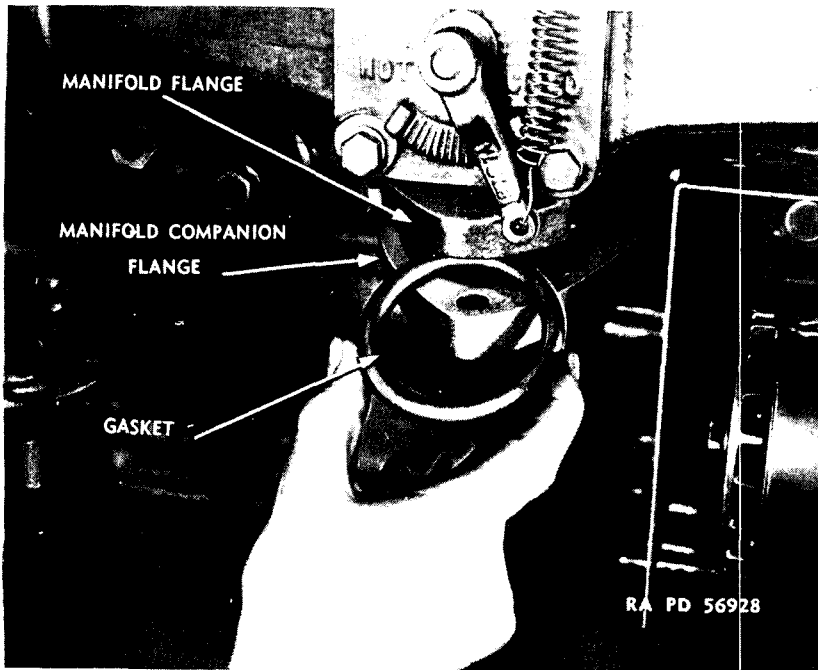
(7) **REMOVE MANIFOLD** (fig. 33). Take the nuts from the 10 studs that hold the manifold to the engine block, and remove manifold and gaskets.

**d. Installation.**

(1) **ATTACH MANIFOLD TO ENGINE.** Bring manifold, with new gaskets affixed, into position against the engine wall with the engine studs in place through the manifold slots. Bring the lower flange or collar of the manifold down over the exhaust pipe. Make sure the



GENERATING UNIT M7



**Figure 34—Manifold Flange Gasket Installation**

pipe reaches up into the top flange. Tighten the bolts that attach the flanges together with the ring gasket (fig. 34) set between. Tighten lock bolt through the upper flange. Place lock washers and nuts on the manifold attaching studs.

(2) **ATTACH CARBURETOR.** Bring assembly of air cleaner, carburetor, and throttle down in place on the manifold flange, with gasket between. Attach with the two cap screws holding throttle box to manifold flange.

(3) **CONNECT BREATHER PIPE.** Attach fitting at end of breather pipe to valve cover with cap screw and lock washer.

(4) **CONNECT GOVERNOR LINKAGE.** Bring governor linkage rod to governor arm, and attach nut, coupling them together.

(5) **ATTACH CHARGING GENERATOR GUARD.** Replace guard, and install cap screws holding it in place.

(6) **TURN CHARGING GENERATOR.** Loosen lock nut holding charging generator set screw. Turn generator so the regulator on top is in position under the guard on a center line with generator housing set screw. Tighten set screws and lock nut.

**57. EXHAUST PIPE.**

a. **Description.** A Z-shaped exhaust pipe carries the exhaust gases from manifold to exhaust muffler. One end of this pipe fits through

## EXHAUST SYSTEM

the manifold companion flange, through a ring gasket, and into the manifold lower flange. A horizontal hexagonal-head set screw through the manifold flange holds the pipe firmly in place. The companion flange bolts to the manifold flange. The pipe fits into the muffler through a collar provided with a tightening strap that holds the two securely together. The two long sections of the pipe are covered with woven asbestos sheeting, held in place by metal straps.

**b. Maintenance.** Examine exhaust pipe regularly for cracks. Take particular note of welded joints. Test regularly for tightness of connections with muffler and manifold. Clean out at regular intervals.

**c. Removal.**

(1) **REMOVE EXHAUST GUARD TRAY.** Loosen the four screws attaching expanded metal exhaust guard tray to tabs, and remove tray.

(2) **DISCONNECT EXHAUST PIPE FROM MANIFOLD.** Loosen manifold companion flange cap screws. Remove manifold upper flange retaining screw. Remove exhaust pipe from manifold flanges. If pipe will not come free, the next operation will automatically release it.

(3) **REMOVE MUFFLER AND EXHAUST PIPE.** Unscrew nuts at both ends of muffler strap screws, and remove straps and muffler.

**d. Installation.**

(1) **CONNECT EXHAUST PIPE TO MANIFOLD** (fig. 35). Loosen manifold companion flange cap screws. Loosen manifold flange retaining screw. Slide exhaust pipe into place through manifold flanges. Tighten lower flange cap screws.

(2) **INSTALL EXHAUST GUARD TRAY.** Attach exhaust guard tray to engine by loosening the side cap screws attaching oil pan to engine over the exhaust pipe, and sliding the four metal tabs attached to the guard under the cap screw heads. Tighten cap screws.

## 58. MUFFLER.

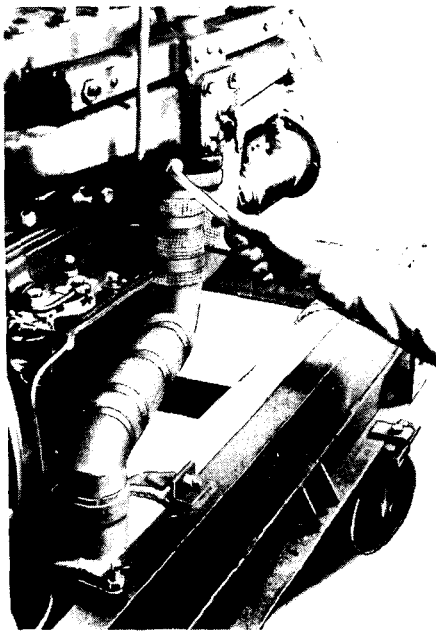
**a. Construction.** The exhaust muffler (fig. 36), a long steel cylinder, is strapped to the frame at the right of the engine. One end has a right-angle pipe connection fitted with an adjustable strap collar for holding to the exhaust pipe. The other end is fitted with a 2-inch pipe extending beyond the muffler to receive the flexible exhaust tube.

**b. Functioning.** The muffler deadens the sound and shock of the exhaust by means of an arrangement of baffles, tubes, and passages.

**c. Maintenance.** The only requirements for muffler maintenance are inspection for cracks or evidence of burning out and checking for tightness of connections. Troubles or defects call for immediate replacement.

**d. Removal.** For instructions on removing muffler, see paragraph 57 c.

GENERATING UNIT M7



RA PD 56929

**Figure 35—Exhaust Pipe Installation—Tightening Companion Flange Screw**

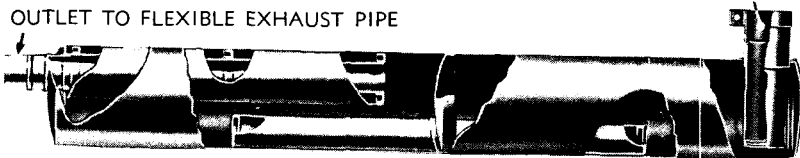
e. **Installation.** Put bolt ends of muffler straps through holes provided in bottom flange of frame side channel, and attach nut. Slide small end of muffler through aperture in radiator support panel. Bring muffler straps up around muffler, and bolt to angle flanges welded to frame.

**59. FLEXIBLE TUBE.**

a. **Description.** A 2-inch flexible steel tube, 52 inches long, is carried in clips on the right-hand side of the unit to be used in carrying away exhaust gases when the unit is in operation. One end of the tube is fitted with an adjustable sleeve of steel for clamping over the muffler extension that projects through the front apron. The other end is finished off with a narrow steel ferrule.

INLET FROM EXHAUST PIPE

OUTLET TO FLEXIBLE EXHAUST PIPE



RA PD 56930

**Figure 36—Exhaust Muffler—Showing Construction**

Section XII

FUEL SYSTEM

	Paragraph
Description .....	60
Trouble shooting .....	61
Fuel tank .....	62
Fuel pump .....	63
Carburetor .....	64
Air cleaner .....	65
Governor .....	66
Throttle box .....	67

60. DESCRIPTION (fig. 37).

a. **Construction.** The fuel system consists of the fuel tank with a flame-proof filler cap and screen (fig. 38), and a mechanical, float-type fuel gage (fig. 39), the fuel pump, the carburetor, the air cleaner, the intake section of the manifold, the governor, the throttle box, linkage between governor and throttle box, a  $\frac{5}{16}$ -inch fuel line (fig. 40), and a  $\frac{1}{4}$ -inch drain line. The capacity of the fuel tank is 26 gallons.

b. **Functioning.** Suction action of the fuel pump brings the fuel from the tank to the pump, which then forces it to the top of the carburetor, where it is sprayed into the air intake to form an air and fuel vapor mixture. The suction of the engine pistons pulls the air through the air cleaner into the carburetor where it picks up fuel vapor. The mixture is then drawn through the throttle box to the intake section of the manifold. The governor (fig. 47), operated from the timing gear, is set to hold the engine at a predetermined speed. The choke, operated manually from the instrument panel, regulates the air supply, and thereby makes the fuel mixture lean or rich. The throttle, also operated manually from the instrument panel, reduces the amount of mixture supplied to the engine.

61. TROUBLE SHOOTING.

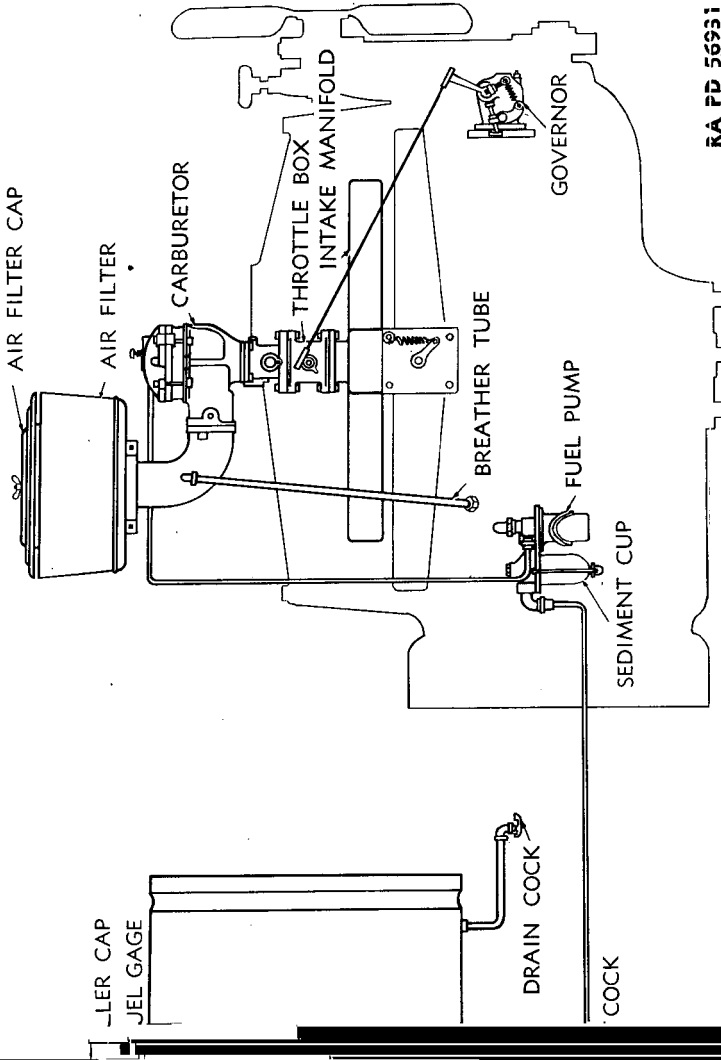
a. Many symptoms which might be attributed to the fuel system are in reality due to faulty ignition. Before attempting any but the obviously required adjustments, check the ignition system thoroughly (par. 45).

b. Engine Will Not Start.

**Possible Cause**  
Dirt or water in system.

**Possibly Remedy**  
Clean sediment cup. Clean fuel pump strainer. Disconnect fuel lines, and blow them out with air.

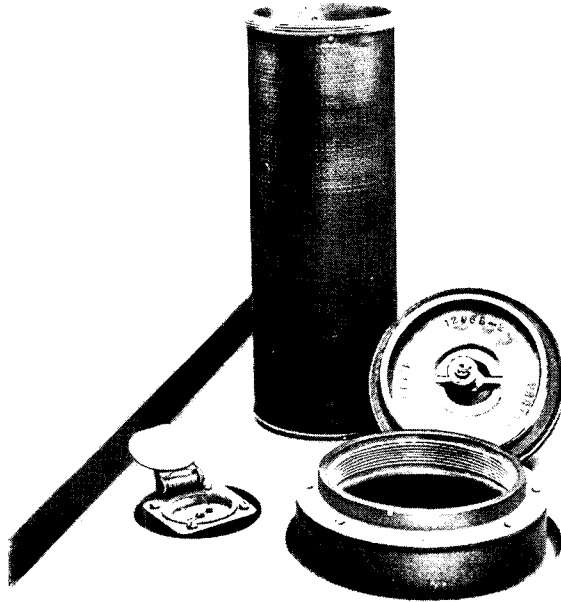
GENERATING UNIT M7



RA FD 56931

Figure 37—Fuel System Diagram

**FUEL SYSTEM**

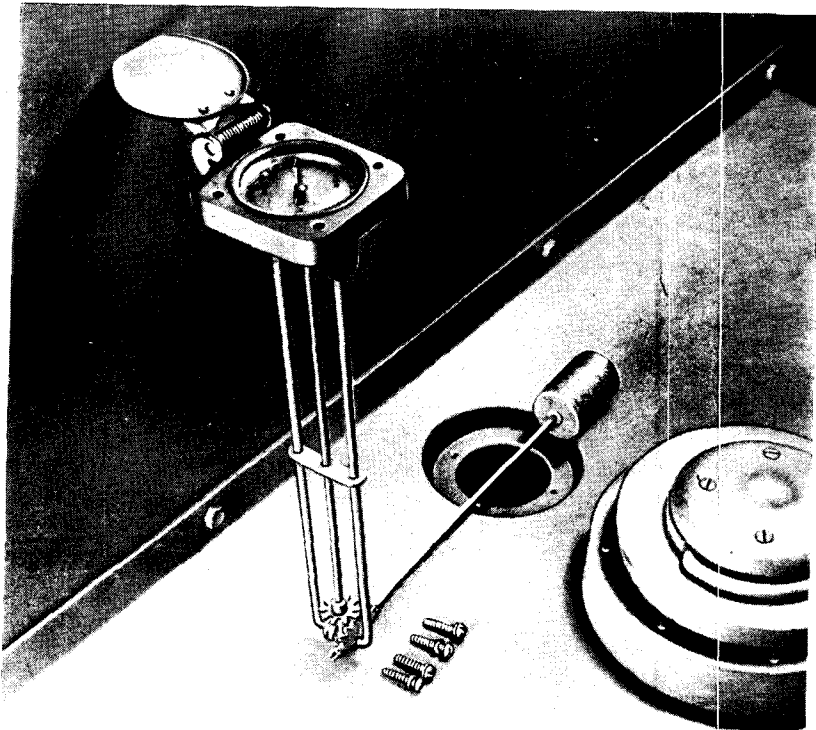


RA PD 56933

**Figure 38—Fuel Tank Filler Cap and Screen**

<b>Possible Cause</b>	<b>Possible Remedy</b>
Flooded engine.	Pull throttle knob out. Crank engine for 10 seconds. When engine starts, push throttle knob part way in.
Lack of fuel or fuel gage defective.	Test tank supply with gage stick. Fill tank or replace gage.
Leaks in line or loose connections.	Replace line or tighten connections.
Defective fuel pump.	Replace.
<b>c. Engine Runs Irregularly at Idling Speed.</b>	
Carburetor mixture too rich.	Turn carburetor idling adjusting screw counterclockwise to obtain a leaner mixture.
<b>d. Black Smoke in Exhaust and Muffler Backfires.</b>	
Carburetor mixture too rich.	Turn carburetor idling adjusting screw counterclockwise to obtain a leaner mixture.
<b>e. Loss of Power.</b>	
Dirty air cleaner.	Service cleaner.
Dirty fuel lines.	Blow out lines.

GENERATING UNIT M7



RA PD 56934

**Figure 39—Fuel Gage—Mechanical Type**

**f. Engine Surges, then Dies or Goes at Low Speed.**

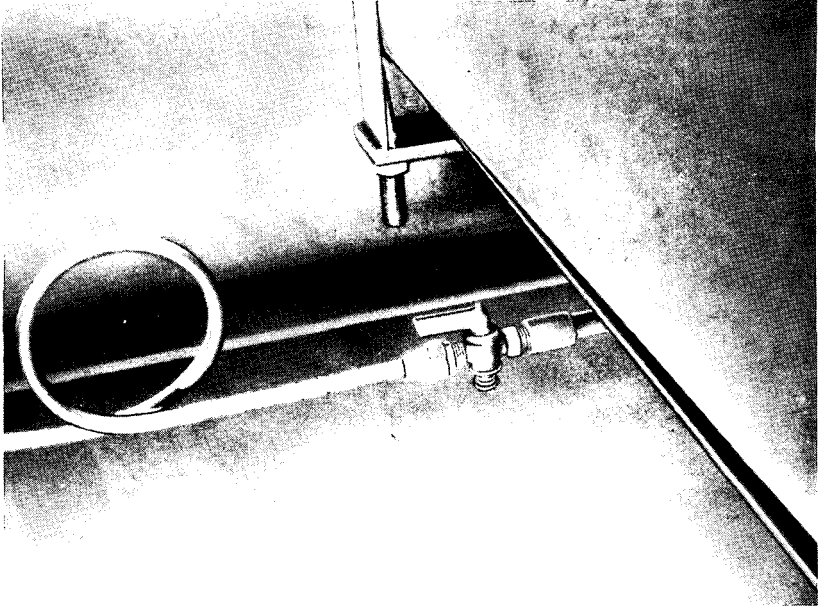
Possible Cause	Possible Remedy
Broken butterfly valve.	Replace throttle box.
Faulty governor.	Report to ordnance personnel.

**62. FUEL TANK (fig. 6).**

**a. Construction.** The fuel tank is located at the rear of the unit, enclosed by a sheet metal guard. The fuel line feeds from a bottom pipe tap on the right-hand side. A short drain line ending with a drain cock is placed opposite. The filler cap is provided with a special flame-arrester screen (fig. 38).

**b. Maintenance.** The platform underneath the fuel tank should be inspected frequently for signs of leaks. Fuel tank connections should also be inspected and tested frequently. The fuel gage should be checked frequently. Its accuracy can be determined by the indications before and after filling.

**FUEL SYSTEM**



RA PD 56936

**Figure 40—Fuel Line at Tank—Showing Shut-off Cock**

**63. FUEL PUMP.**

**a. Description.** The fuel pump (fig. 41) is a mechanical, diaphragm-type, which is attached to the crankcase and operated by an eccentric on the engine camshaft. The vacuum created by the pump draws the fuel from the tank to the pump. The diaphragm then forces the fuel from the pump to the carburetor. Before the fuel reaches the pump proper, it flows through a strainer into a removable glass sediment cup where water and impurities fall to the bottom. The fuel flow passes across the top of this cup.

**b. Trouble Shooting.**

**(1) FUEL LEAKS.**

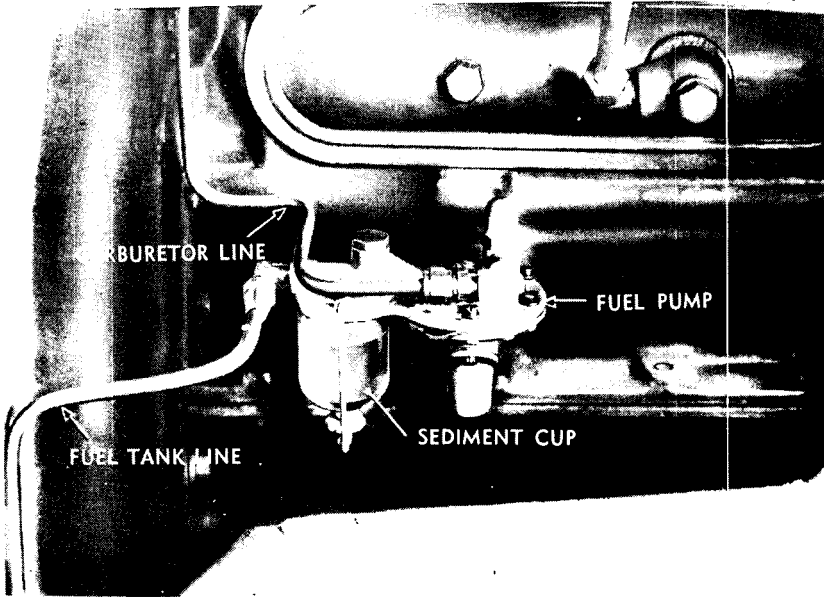
<b>Possible Cause</b>	<b>Possible Remedy</b>
Loose fuel sediment cup.	Tighten cup thumb screw. Replace gasket, if necessary.
Loose fuel line fitting.	Tighten inlet and outlet fittings. Replace, if fittings are stripped.
Loose fuel pump cover.	Tighten cover screw.

**(2) LOW FUEL PRESSURE.**

Air leaks in system.	Tighten connections.
Clogged strainer.	Service strainer.

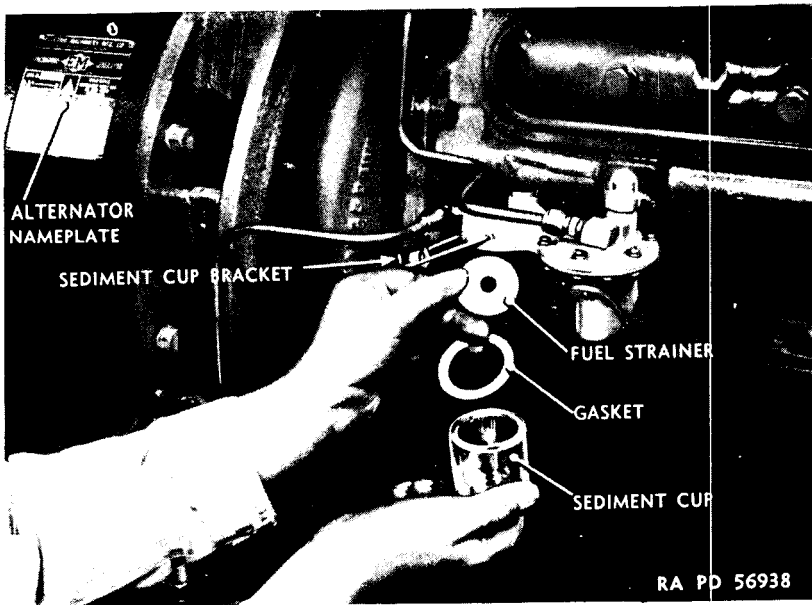


GENERATING UNIT M7



RA PD 56937

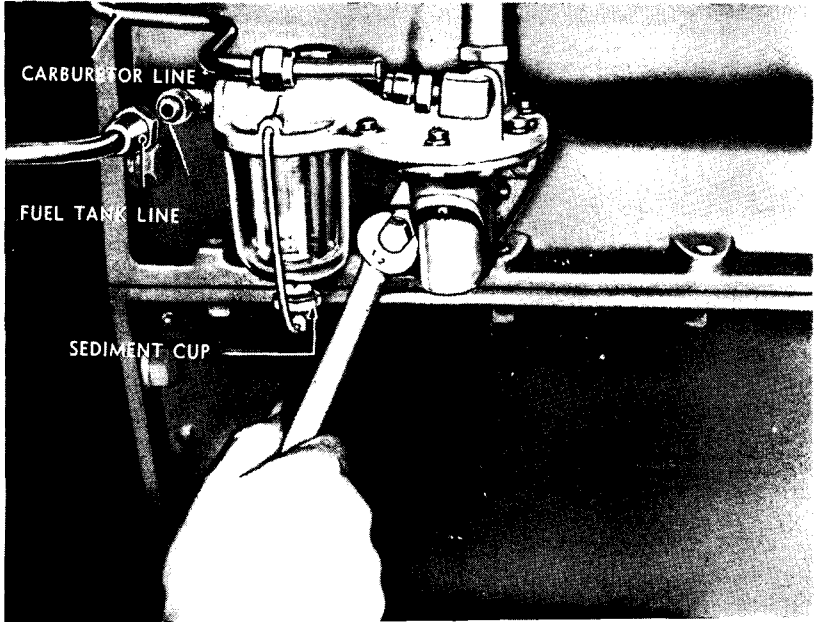
Figure 41—Fuel Pump



RA PD 56938

Figure 42—Sediment Cup and Fuel Strainer Removal

FUEL SYSTEM



RA PD 56939

**Figure 43—Fuel Pump Removal (1)**

**(3) NO FUEL PRESSURE.**

Possible Cause	Possibly Remedy
Defective pump diaphragm.	Replace pump.

c. **Maintenance.** The glass sediment cup should be examined daily, and emptied whenever water is found at the bottom. The cup and the wire mesh strainer above it (fig. 42) should be cleaned frequently by washing in SOLVENT, dry-cleaning.

**d. Removal.**

(1) **DISCONNECT FUEL LINES FROM PUMP.** Disconnect fuel tank line and carburetor line at fuel pump.

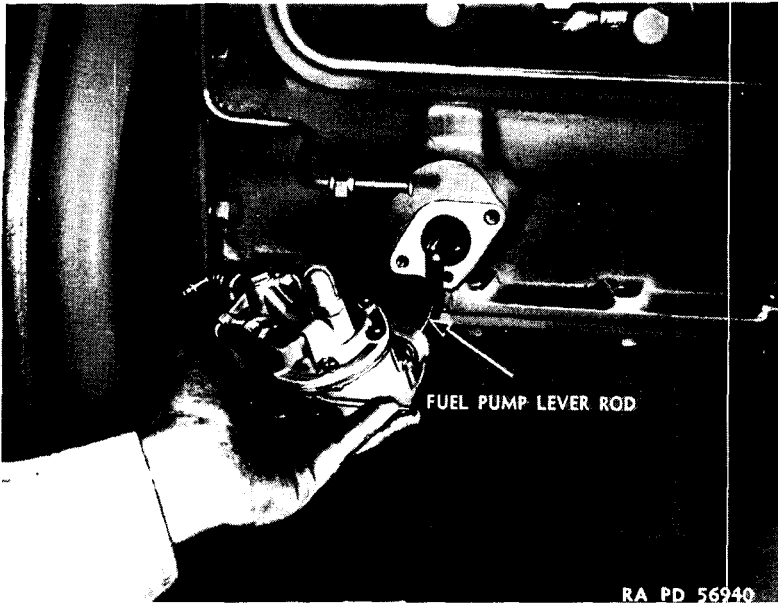
(2) **REMOVE PUMP.** Take out the two cap screws and lock washers that hold the pump to the engine, and remove pump (fig. 44).

**e. Installation.**

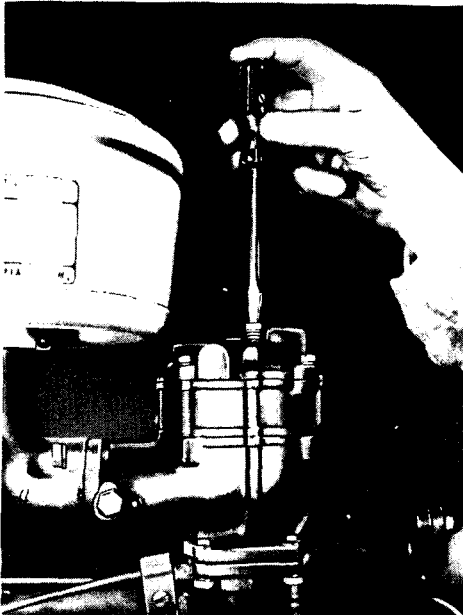
(1) **INSTALL PUMP.** Install pump at slight upward angle to get pump lever rod into its proper position on the camshaft. If some resistance is not met against the lever pressure, the lever rod is not riding against the cam, and the angle should be altered slightly and tried again. When the pump is correctly positioned, secure to engine with cap screws and lock washers. Use new gasket when installing pump.

(2) **CONNECT FUEL LINES TO PUMP.** Connect fuel tank line and carburetor line to fuel pump.

GENERATING UNIT M7



**Figure 44—Fuel Pump Removal (2)**



**Figure 45—Idling Speed Mixture Adjusting Screw**

**FUEL SYSTEM**

**64. CARBURETOR.**

**a. Description.** The carburetor (fig. 45) is a downdraft-type, located over the intake section of the manifold above the throttle box. It is connected by a cast-iron elbow to the air filter. The fuel intake is controlled by a float-regulated needle valve that maintains a constant fuel level in the chamber as the suction of the pistons draws the mixture down to the intake manifold. At the top of the carburetor is an adjusting screw which controls the amount of air drawn in to the idling jet. This controls richness of the air and fuel mixture for idling speed only. The idling fuel vapor section of the carburetor is inoperative as soon as the main throttle is opened, and the engine has reached high speed. Throttle and choke adjustment levers on the carburetor have linkage connections to instrument panel knobs that adjust the amount of air and fuel taken into the carburetor during starting and stopping.

**b. Trouble Shooting.**

**(1) ENGINE SPUTTER, REGULAR OR INTERMITTENT.**

Possible Cause	Possible Remedy
Carburetor check valve stuck or defective.	Replace carburetor.

**(2) CHOKES AT IDLING SPEED.**

Flooded carburetor resulting from stuck or defective check valve.	Replace carburetor.
---	---------------------

**(3) BLACK SMOKE IN EXHAUST AND MUFFLER BACKFIRES.**

Carburetor mixture too rich.	Turn carburetor adjusting screw counterclockwise for leaner mixture.
------------------------------	--

**(4) LOSS OF POWER.**

Dirty air cleaner.	Service cleaner.
--------------------	------------------

**(5) ENGINE SURGES, THEN DIES OR GOES AT LOW SPEED.**

Broken butterfly valve.	Replace throttle box.
Faulty governor.	Report to ordnance personnel.

**(6) STICKING CONTROLS.**

Carburetor choke.	Free valve shaft and linkage, and lubricate.
Carburetor throttle.	Adjust choke control. Free shaft and linkage, and lubricate.

**(7) TOO RICH MIXTURE.**

Carburetor choke not fully opening.	Free valve shaft, and lubricate. Adjust choke control.
-------------------------------------	--

**(8) ENGINE DIES.**

Engine will not idle.	Adjust idling screw.
-----------------------	----------------------

**(9) FAST IDLING.**

Improper control adjustment.	Adjust throttle control button and throttle stop screw.
------------------------------	---

## GENERATING UNIT M7

Possible Cause	Possible Remedy
Carburetor throttle stuck.	Free shaft and linkage, and lubricate.
Bent or kinked tubing.	Straighten, or replace tubing.
Stopped up filter element.	Clean or replace.
Faulty fuel pump.	Replace pump.
Dirty fuel filter element.	Clean and blow out filter element.
Dirty air cleaner.	Clean.
Fuel leaks at fuel filter.	Tighten filter bowl. Replace bowl gasket. Tighten lines.
Fuel leaks at carburetor.	Tighten cover body screw. Report to ordnance personnel if condition continues.

### c. Maintenance.

(1) **INSPECTION.** The carburetor needs very little attention if properly installed. Inspect for air leaks, and check for worn or faulty gaskets.

(2) **ADJUSTMENT.** When necessary, adjust mixture adjusting screw at top of carburetor. Turning clockwise makes richer mixture; counterclockwise, leaner mixture (fig. 45).

### d. Removal.

(1) **DISCONNECT FUEL LINE FROM CARBURETOR.** Loosen nut on compression fitting at back of carburetor, and remove fuel line from carburetor.

(2) **DISCONNECT AIR CLEANER ELBOW.** Remove bolts holding air cleaner elbow to carburetor. Breather pipe will hold air cleaner and air cleaner elbow in place.

(3) **REMOVE CHOKE AND THROTTLE LINKAGE.** Loosen screws securing choke, and throttle wire to carburetor, and remove wires.

(4) **REMOVE CARBURETOR.** Take out cap screws, lock washers, and nuts holding carburetor to throttle box, and remove carburetor.

### e. Installation.

(1) **INSTALL CARBURETOR ON THROTTLE BOX.** With gaskets in place, install cap screws, lock washers, and nuts that attach carburetor to throttle box.

(2) **CONNECT AIR CLEANER ELBOW AND CARBURETOR.** Install cap screws to connect air cleaner elbow and carburetor.

(3) **ATTACH CHOKE AND THROTTLE LINKAGES.** Attach throttle wire to throttle lever and choke wire to choke lever on carburetor.

(4) **CONNECT FUEL LINE.** Carry compression fitting nut over the end of the fuel line, bring fuel line into fitting, and tighten nut to produce a firm joint.

## 65. AIR CLEANER (fig. 46).

a. **Construction.** The air cleaner is located above the rear of the engine and is connected to the carburetor by a cast-iron elbow. It has

**FUEL SYSTEM**

a removable cap fitted with a ring-type, steel-wire filter element. A center stud fitted with a wing nut holds the cap in place with about an inch of space left all around for air to be drawn in.

**b. Functioning.** Air is drawn into the cleaner through the aperture between cap and base, and is filtered through the steel-wire ring.

**c. Trouble Shooting.**

(1) **LOSS OF POWER.**

Possible Cause	Possible Remedy
Air cleaner restricted.	Service cleaner.

**d. Maintenance.** Inspect air cleaner to determine if filter element and oil bath are clogged. If so, proceed to clean as follows:

(1) Remove the air filter from the carburetor after loosening clamp screws that hold filter pan to elbow. Remove the wing nut from the top of the filter, and take off the cover.

(2) Empty the oil out of the filter, and clean out all oil and accumulated dirt. Wash body with SOLVENT, dry-cleaning, and wipe dry. Wash filter element by slushing up and down in SOLVENT, dry-cleaning. Dry thoroughly, either with an air hose or by letting it stand until dry. Fill the body of the filter to bead level with used crankcase oil or OIL, engine, temperature grade, above zero degree F. Operate dry below zero degree F.

(3) Replace cover and install the filter on the carburetor elbow. Tighten clamp.

**66. GOVERNOR.**

**a. Construction.** The governor is a gear-driven, spring-loaded, flyball-type unit mounted on the right front side of the timing gear cover. It is connected through linkage with the throttle box valve.

**b. Functioning.** The governor, driven from the camshaft gear, controls the amount of opening in the throttle box valve. It has a calibrated spring control held at a predetermined setting, which should not be changed without permission of higher authority.

**c. Trouble Shooting.**

(1) **SURGING.**

Possible Cause	Possible Remedy
Faulty adjustment.	Adjust, under supervision, or report to ordnance personnel.

**d. Adjustment.** As put in service, the governor is adjusted to keep the engine running at 1,200 rpm, full load, and 1,230 rpm, no load. This adjustment should be carefully maintained. The following information will aid in minor adjustment. Other adjustments should be made only under supervision of higher authority.

(1) To increase speed, increase the spring tension by screwing in adjusting screw "A" (fig. 47). To decrease speed, decrease the spring tension. Be sure to tighten the lock nut after making an adjustment.

GENERATING UNIT M7

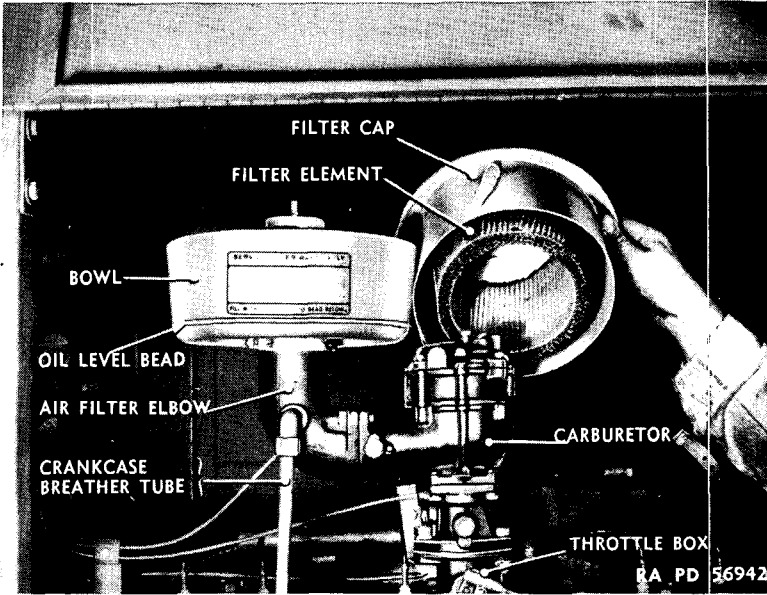


Figure 46—Air Filter and Cap

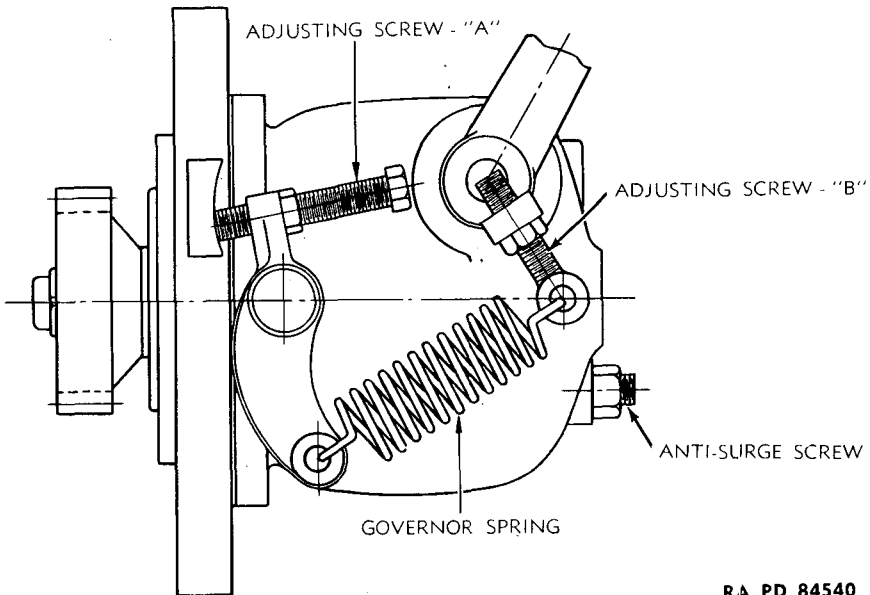


Figure 47—Governor Diagram

**ENGINE LUBRICATION SYSTEM**

**NOTE:** Do not change the adjustment of adjusting screw "B" without permission from higher authority.

(2) The linkage, or rod, connecting the governor arm to the throttle arm must be of the correct length, and the throttle arm must be set so that it is at right angles to the rod when it is in the middle of its travel, thus giving free movement from an "OPEN" to a "CLOSED" position. Also, the throttle and joints of the rod must be absolutely free during the full travel of the parts. The rod is adjustable as to length and must be adjusted so that, with unit at rest and governor and throttle in their normal "WIDE-OPEN" positions, it will hold the throttle arm about  $\frac{1}{64}$  inch away from its "WIDE-OPEN" position. There will usually be some tension on the spring when the unit is at rest. If there is no tension, when checking for length of rod as outlined above, be sure the governor arm is all the way back in the direction the spring would pull it.

**67. THROTTLE BOX.**

**a. Removal.**

(1) **DISCONNECT GOVERNOR LINKAGE ROD AT GOVERNOR ARM.** Hold nut and take out screw fastening governor linkage to governor arm. *Do not disconnect at throttle box.*

(2) **TAKE OUT THROTTLE BOX** (fig. 48). Remove cap screws, lock washers, and nuts holding throttle box and gasket to bottom of carburetor. Remove screws and lock washers connecting the throttle box to intake manifold flange. Remove throttle box and gasket. Carburetor will be held up by breather pipe (fig. 49).

**b. Installation.**

(1) **INSTALL THROTTLE BOX.** With gaskets in place at top and bottom, set throttle box between carburetor and intake manifold. Install cap screws and lock washers to connect throttle box to manifold flange, and cap screws, lock washers, and nuts to connect to carburetor.

(2) **CONNECT LINKAGE ROD.** Hold nut and install screw attaching governor arm to linkage.

**Section XIII**

**ENGINE LUBRICATION SYSTEM**

	Paragraph
Description .....	68
Trouble shooting .....	69
Filter .....	70
Strainer .....	71
Oil pump .....	72



**GENERATING UNIT M7**

**68. DESCRIPTION (fig. 50).**

a. The engine oil system provides continuous lubrication by means of a submerged-type gear pump driven from the camshaft. From the oil sump at the bottom of the crankcase, the pump draws oil through a strainer screen (fig. 57) and forces it to the main oil gallery, drilled in the cylinder block on the side opposite the camshaft. From here the oil is forced to the main and connecting rod bearings, front camshaft bearing, and governor. The rear and center camshaft bearings, cylinder walls, pistons, and valve tappets are all lubricated by oil thrown from ends of main and connecting rod bearings.

b. A certain amount of the oil forced to the gallery is taken off through a bypass, sent through the oil filter (fig. 53) and back to the sump. A pressure regulating valve on the gallery operates to allow oil to flow directly back to the sump when the oil pressure becomes too great. The pressure regulating valve is adjustable by means of a screw (fig. 55) in the base of the oil filter. This valve is adjusted at the factory when the unit is regulated and must not be disturbed except under supervision of higher authority.

c. The oil filler pipe (fig. 51), which also functions as a breather, is located on the left side of the unit. The filler pipe cap is painted red. Other oilers and grease fittings are identified by a red circle  $\frac{3}{4}$  inch in diameter. Approximately 7 quarts of oil are needed for the oil pan, an additional quantity being required for the oil filter. From a tapped hole in the base of the oil filter, a copper tubing oil gage line leads to the oil gage on the instrument panel. The oil pressure should be approximately 25 pounds at 1,200 rpm, with the unit fully warmed up. When it is first started, the pressure will be slightly higher.

**69. TROUBLE SHOOTING.**

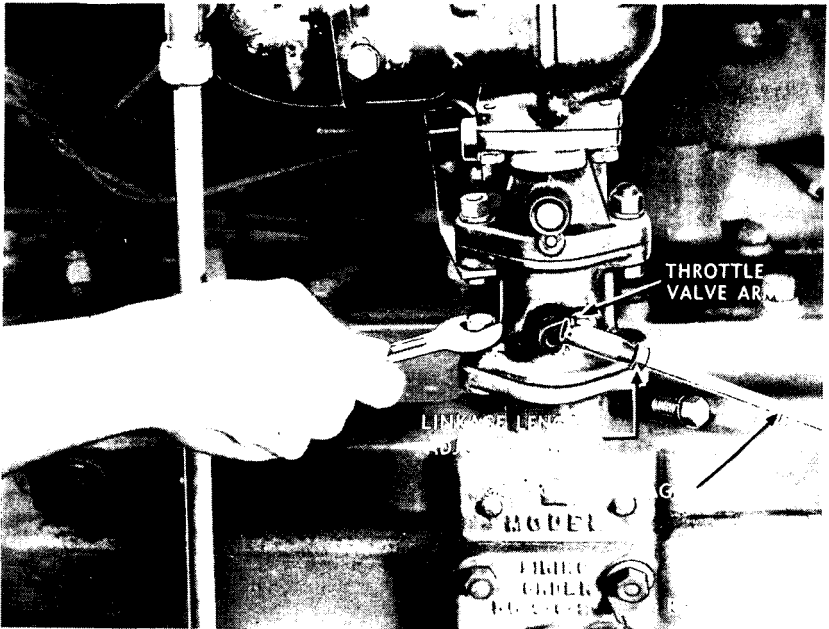
**a. Excessive Oil Consumption.**

Possible Cause	Possible Remedy
Improper grade of oil.	Use oil as recommended in section IV.
Oil level too high.	Drain to proper level.
Excessive oil pressure.	Report to ordnance personnel.
Oil leaks.	Tighten gaskets and oil line fittings.

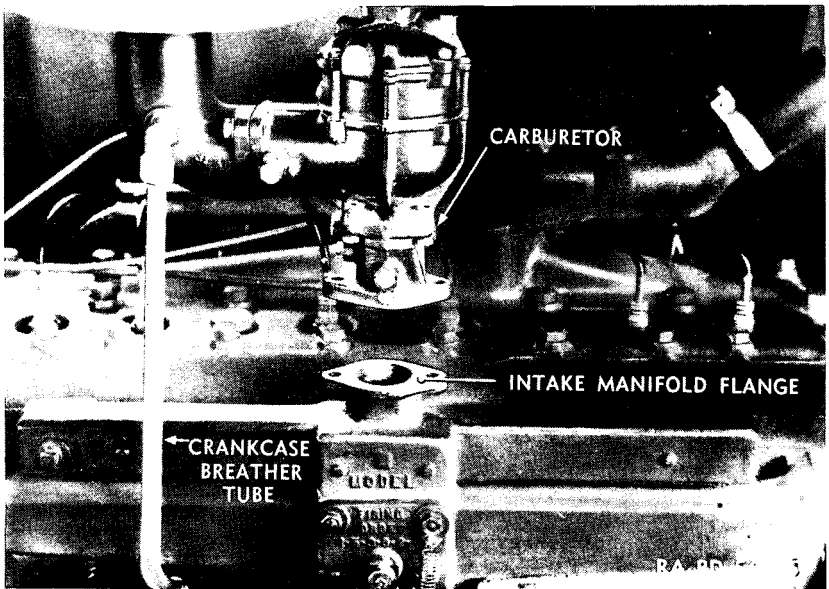
**b. Low Oil Pressure.**

Improper grade of oil.	Use oil as recommended in figure 13.
Lack of oil in crankcase.	Fill crankcase to proper level.
Relief valve stuck.	Report to ordnance personnel.
Oil pump screen clogged.	Remove and clean.
Oil pump worn.	Report to ordnance personnel.

**ENGINE LUBRICATION SYSTEM**



**Figure 48—Throttle Box Removal**



**Figure 49—Throttle Box Removed**

GENERATING UNIT M7

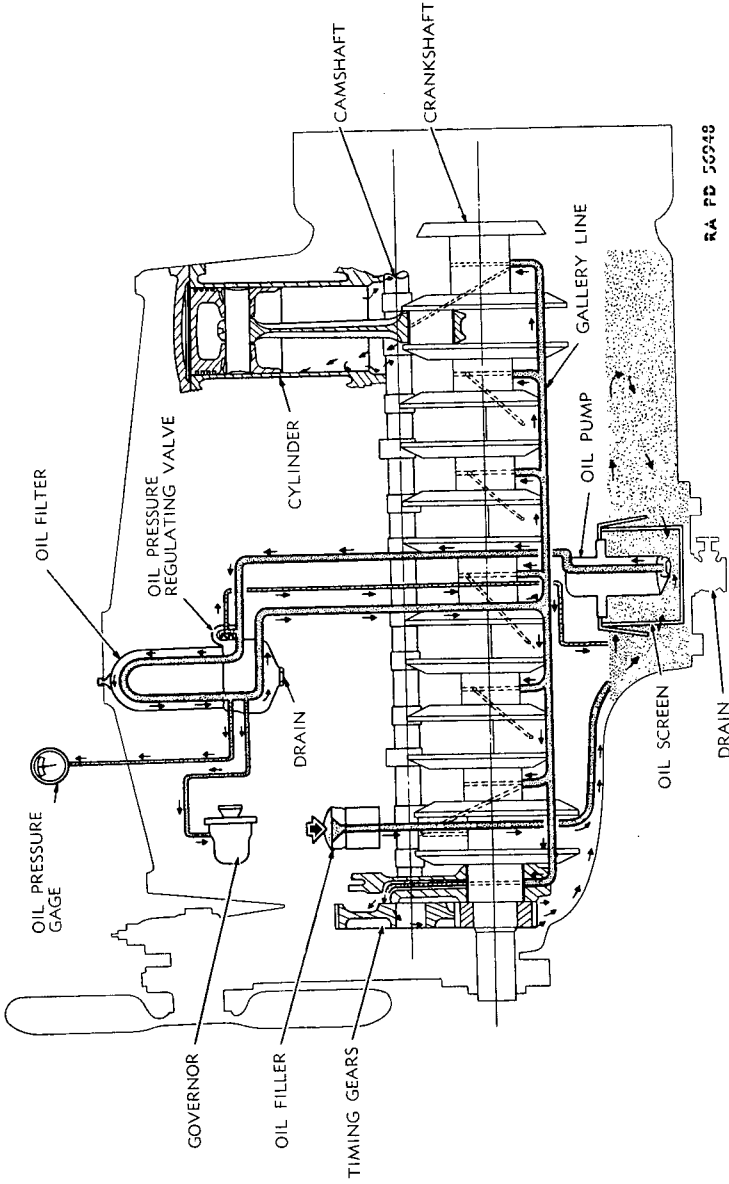
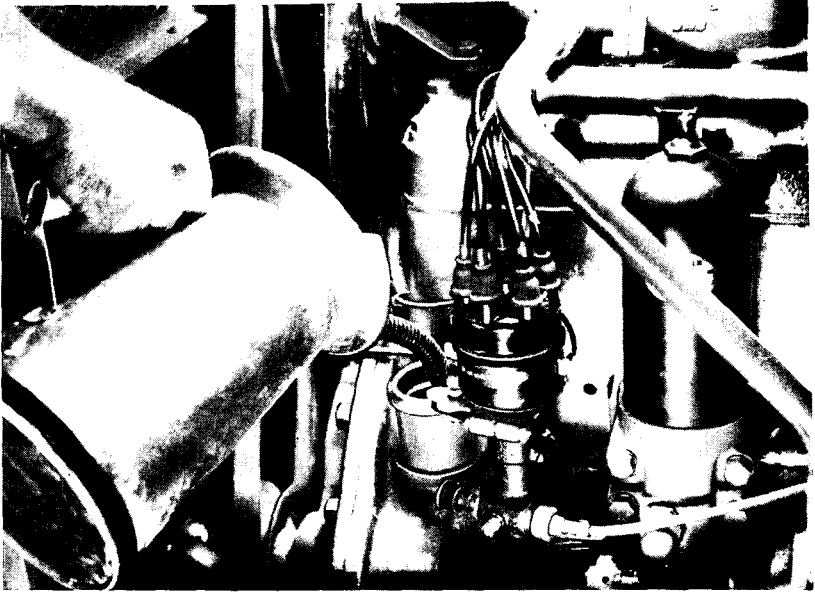


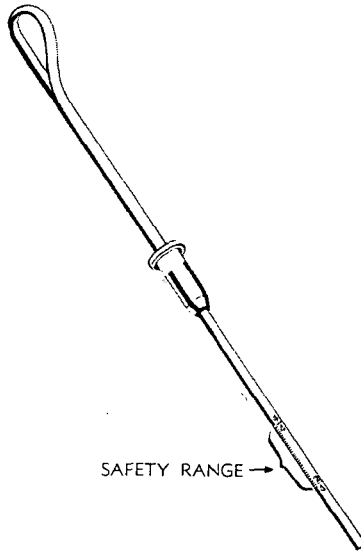
Figure 50—Engine Lubrication System

**ENGINE LUBRICATION SYSTEM**



RA PD 56949

**Figure 51—Filling Crankcase**



RA PD 56950

**Figure 52—Oil Level Gage**

GENERATING UNIT M7

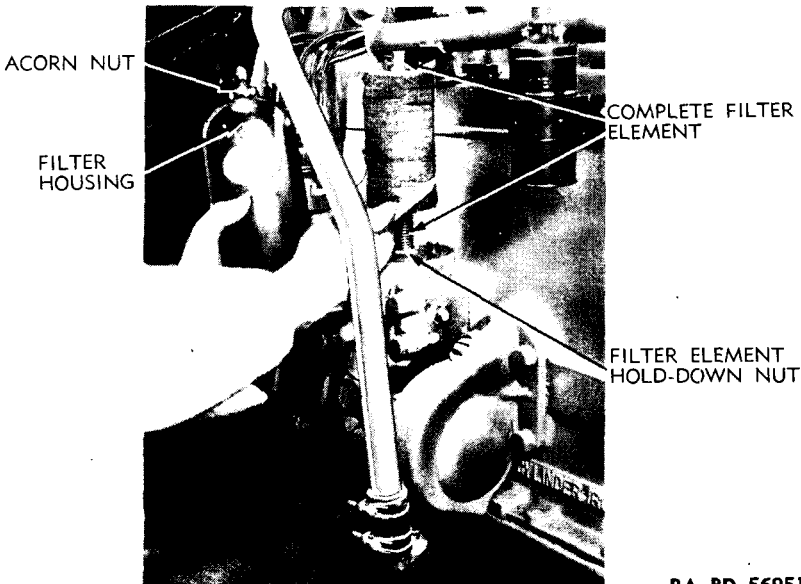


Figure 53—Servicing Oil Filter

RA PD 56951

c. **Discolored Oil.**

Possible Cause	Possible Remedy
Clogged oil filter.	Service or replace filter.
Sludge in oil lines.	Remove and clean lines.
Sludge in oil pan.	Report to ordnance personnel.

70. **FILTER.**

a. **Construction.** The oil filter (fig. 53), on the left side of the engine next to the distributor, has a heavy-gage steel, dome-shaped casing over a filter element of round felt pads about a center tube.

b. **Functioning.** The oil is pumped, under pressure, up through the filter tube; it comes out at the top and flows down over the filter element, leaving dirt and other foreign substances on the surface of the element. A sludge plug (fig. 54) in the filter base allows sludge to be drained. An acorn nut at the top of the casing can be taken off and, with the sludge plug removed, the filter may be blown out.

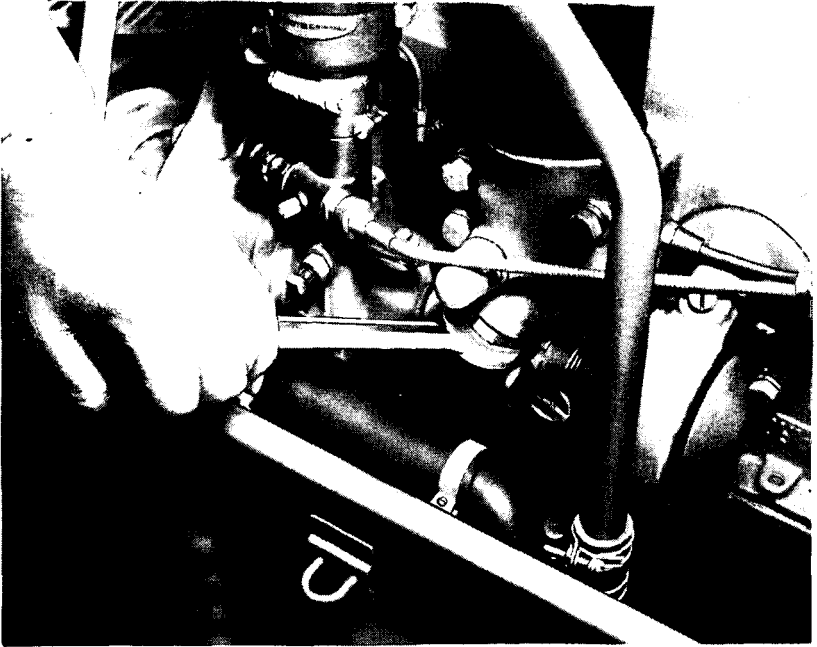
c. **Maintenance.** The oil filter should be cleaned (par. 18 b(6)) either by blowing out with air, or by scraping the element at frequent intervals, or whenever the oil becomes discolored. For further cleaning, the element should be washed in SOLVENT, dry-cleaning.

d. **Removal.**

(1) **REMOVE CASING.** Unscrew hexagonal nut on top of casing, remove gasket, and take off casing.

(2) **REMOVE ELEMENT.** Unscrew element pipe at base, and lift out element.

## ENGINE LUBRICATION SYSTEM



RA PD 56953

**Figure 54—Removing Sludge Plug from Oil Filter Base**

### e. Installation.

- (1) **INSTALL ELEMENT.** Attach element pipe by screwing down over base nipple.
- (2) **ATTACH CASING.** Install cover and secure with nut over gasket.

## 71. STRAINER.

a. **Description.** The oil strainer (fig. 57) is of wire mesh on a steel frame attached to a removable cap at the bottom of the crankcase. The oil pump draws the oil through the strainer mesh.

b. **Maintenance.** The oil strainer should be removed periodically, and cleaned thoroughly with **SOLVENT**, dry-cleaning. This should be done at least every time the crankcase is drained.

### c. Removal.

- (1) **REMOVE CAP** (fig. 56). Take out cap screws and lock washers attaching cap and gasket to crankcase, and lift off oil strainer cap.

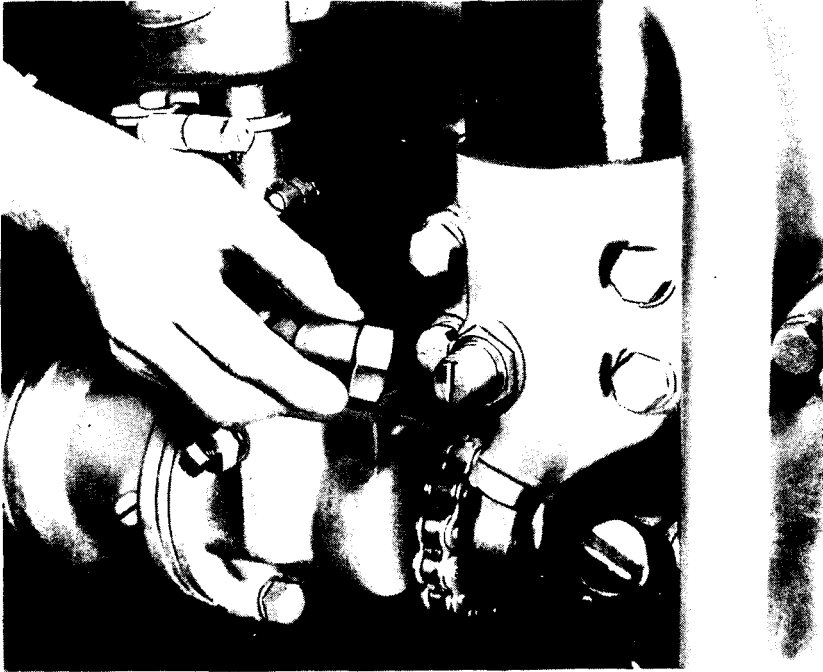
### d. Installation.

- (1) **INSTALL STRAINER.** Place gasket over cap flange, bring cap into position at the bottom of the crankcase, and install with cap screws and lock washers.

## 72. OIL PUMP.

- a. **Description.** The oil pump is of the submerged-type, gear

## GENERATING UNIT M7



RA PD 56954

**Figure 55—Oil Pressure Regulating Valve Screw**

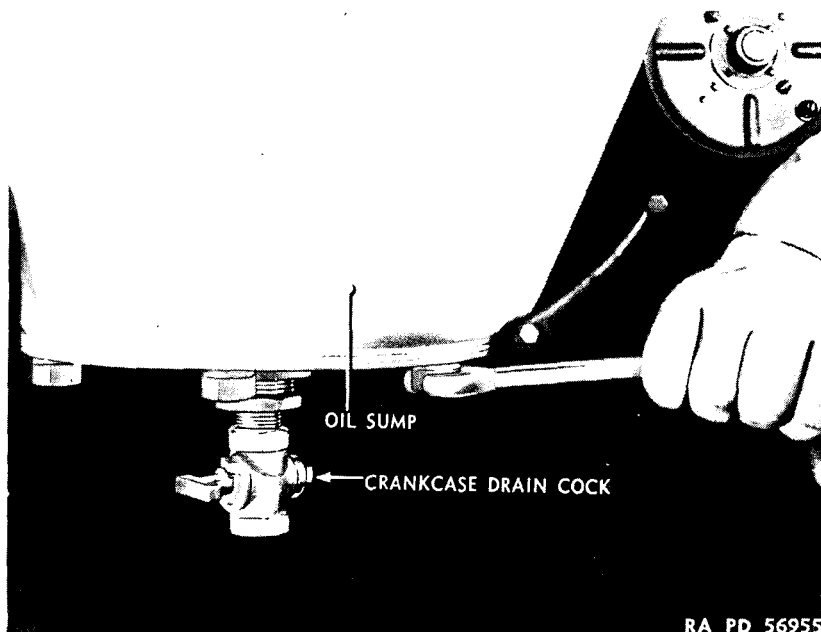
driven from the camshaft. The pump forces oil from the oil sump at the bottom of the crankcase to the points to be lubricated.

**b. Maintenance.** The oil pump requires no maintenance when working properly. Repairs are not within the scope of this manual. Oil pressure can be adjusted by the pressure regulating valve (fig. 55) but this may be done only under supervision of higher authority. To adjust oil pressure proceed as follows:

(1) **REMOVE ACORN NUT AND LOOSEN LOCK NUT.** Take off acorn nut and gasket. Loosen lock nut holding adjusting screw.

(2) **ADJUST VALVE.** The adjusting screw should be turned until the oil pressure gage on the instrument panel registers 25-pound pressure at 1,200 rpm. Tightening the screw increases the pressure, loosening the screw decreases pressure. **NOTE:** The oil pressure should not be changed or judged to be too high or too low until it is known that the proper weight of oil is being used, and the engine is being warmed up to normal operating temperature. As the bearings become worn, more oil will escape around the bearings into the case, lowering the pressure slightly. It is not advisable to try to correct this slight loss of pressure by an adjustment of the pressure regulator because the extra amount of oil being thrown off by the worn bearings is already over-oiling the cylinder walls.

**ENGINE LUBRICATION SYSTEM**



**Figure 56—Oil Strainer Cap Removal**



**Figure 57—Oil Strainer Cap Removed**

RA PD 56956



GENERATING UNIT M7

Section XIV

ENGINE ELECTRICAL SYSTEM

	Paragraph
Description .....	73
Trouble shooting .....	74
Battery .....	75
Battery-charging generator .....	76
Ignition coil .....	77
Distributor .....	78
Spark plugs .....	79
Starting motor .....	80

**73. DESCRIPTION (fig. 58).**

a. The starting and ignition system consists of a 6-volt battery located in a tray bolted to frame cross members on the right-hand side of the unit, opposite the instrument panel; a battery-charging generator (fig. 61), on the right side of the unit under the manifold; a starting motor (fig. 71), on the left side of the engine, projecting through the bell housing; a distributor (fig. 66) mounted on a tachometer drive above the accessory drive; an ignition coil (fig. 65) bolted to the left side of the engine head, and the spark plugs. On the instrument panel are the ignition switch, the starter switch, and the tachometer head.

**b. Functioning.**

(1) **STARTING.** The ignition switch on the instrument panel throws on the 6-volt current in the ignition line. The starter switch on the panel makes the connection to the starting motor which turns over the engine.

(2) **IGNITION.** The battery circuit furnishes the electric spark that ignites the mixture in the cylinders. The ignition switch connects the battery line to the ignition coil, which transforms the 6-volt current to the high voltage required to produce the hot spark necessary for cylinder ignition. The distributor makes the succession of momentary contacts that pass the high-voltage current to the spark plugs in the proper firing order.

(3) **LIGHTING.** The battery line provides an auxiliary lighting circuit for use when the generator is not functioning. A 6-volt pilot light is located on the instrument panel, and a 6-volt receptacle is also provided there to receive the 6-volt trouble light carried in the tool box.

**ENGINE ELECTRICAL SYSTEM**

**74. TROUBLE SHOOTING.**

**a. Engine Fails to Start—Ammeter Showing Pulsating Discharge.**

Possible Cause	Possible Remedy
No spark.	Replace coil-distributor wire.
Weak spark.	Clean and adjust distributor points, or replace condenser.
Weak spark after replacing condenser.	Replace coil.
Distributor cap cracked.	Replace distributor cap.
Grounded distributor rotor.	Replace rotor.
Defective spark plug cable.	Replace cable.
Defective spark plugs.	Service or replace.

**b. Ammeter Indicates Constant Normal Discharge when Engine Is Being Cranked.**

Faulty distributor.	Report to ordnance personnel.
Defective or grounded coil-distributor wire.	Eliminate ground or replace wire.
Defective coil.	Replace coil.

**c. Ammeter Shows No Discharge.**

Distributor faulty.	Report to ordnance personnel.
Defective wire, shorted connection, etc.	Eliminate ground, or replace defective wire.

**d. Engine Fails To Crank.**

Fully discharged battery.	Charge battery.
Starting motor burned out.	Replace motor.
Starting switch faulty.	Replace switch.
Loose connections.	Tighten connections.
Corroded battery terminals.	Replace terminals.

**75. BATTERY (figs. 59 and 60).**

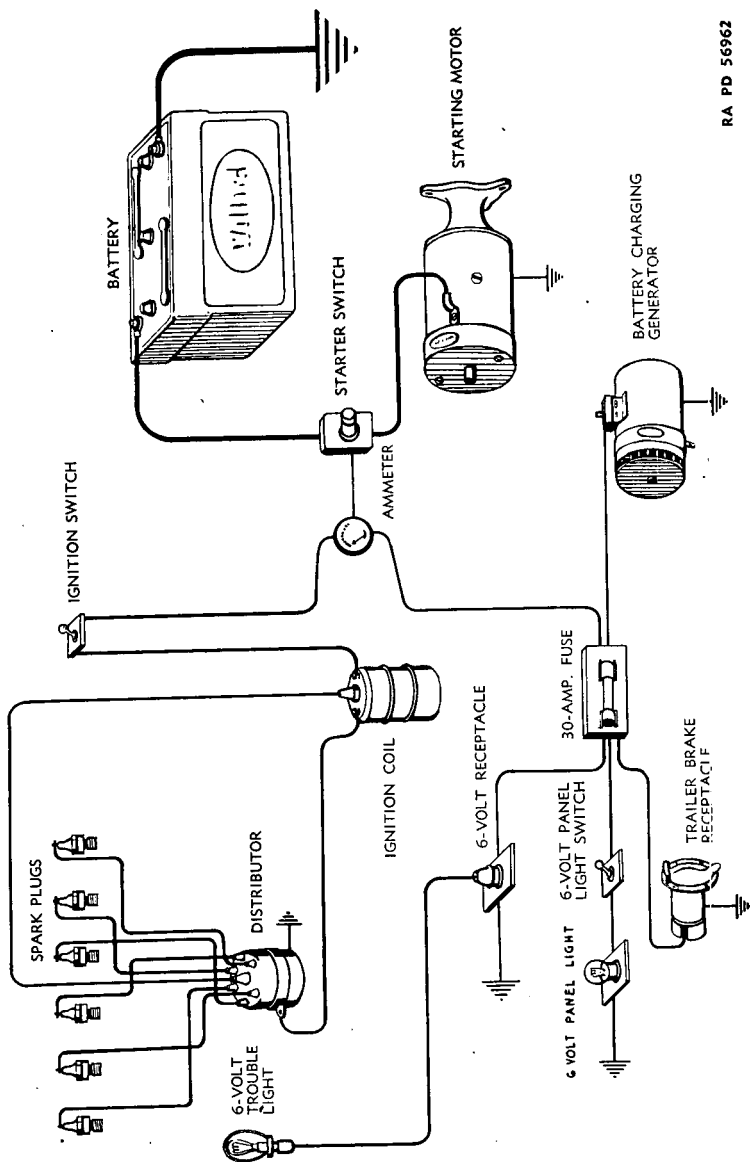
**a. Description.** The battery is located on the right-hand side of the unit, opposite the instrument panel, alongside the center upright of the housing, to which its negative terminal is grounded. The positive terminal is connected to the starter button. Battery capacity is 160 ampere-hours at 20-hour rate.

**b. Trouble Shooting.**

**(1) BATTERY DOES NOT FUNCTION.**

Possible Cause	Possible Remedy
Battery discharged.	Charge battery.
Battery connections corroded.	Clean with file and wire brush and coat with GREASE, general purpose (seasonal grade).
Battery will not charge.	Replace.

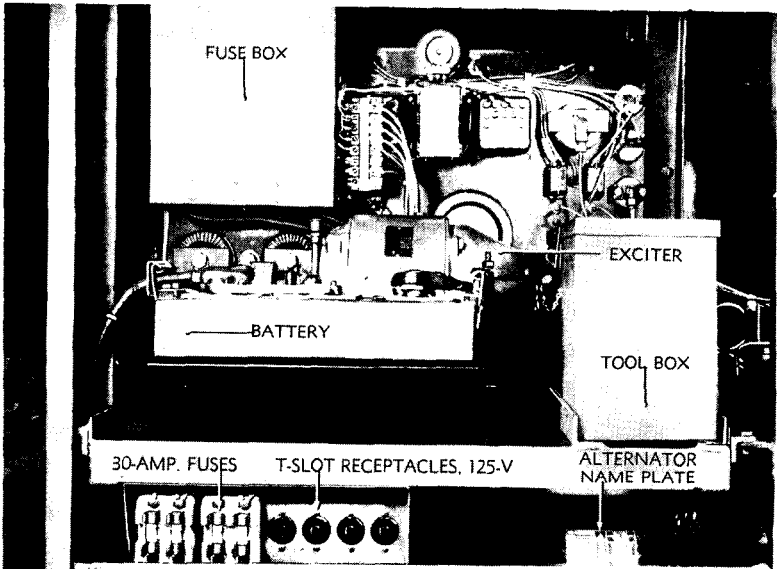
GENERATING UNIT M7



RA PD 56962

Figure 58—Engine Electrical System

**ENGINE ELECTRICAL SYSTEM**



RA PD 56963

**Figure 59—Instrument Panel—U. S. M. Co. Unit—Rear**

**c. Maintenance.**

(1) The battery should always be kept filled with distilled water if available, otherwise with drinking water, to a point approximately  $\frac{3}{8}$  inch above the separators. If the unit is used regularly, the battery should stay in proper charged condition. An idle battery loses its charge. If battery has been discharged, it should be charged by a standard auxiliary battery charger. If this is impossible, it can be charged by the battery-charging generator on the unit. The engine must be started by hand cranking, and complete charging will take upward of 20 hours.

(2) The battery and battery compartment must be kept clean and dry, and the vent plugs tight, although the breather holes in the latter must be kept open.

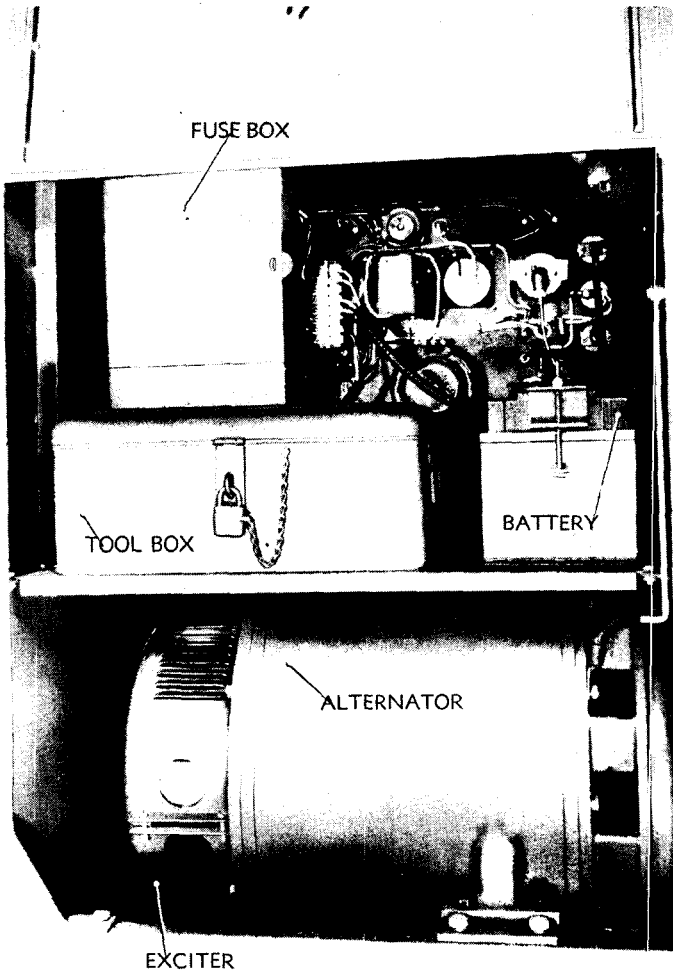
(3) Cables and terminals should be kept tight or the proper connections cannot be maintained. Scrape clean with a coarse wire brush, and then wash surface with hot water and soap. Coat terminals with **GREASE**, general purpose (seasonal grade).

(4) For care of battery in hot and cold climates, see section VI.

**d. Removal.**

(1) **DISCONNECT BATTERY.** Disconnect cable lugs from battery terminals, holding square head of bolt with pliers, and unscrewing nut with open-end wrench.

GENERATING UNIT M7



RA PD 56965

**Figure 60—Instrument Panel—H. B. Co. Unit—Rear**

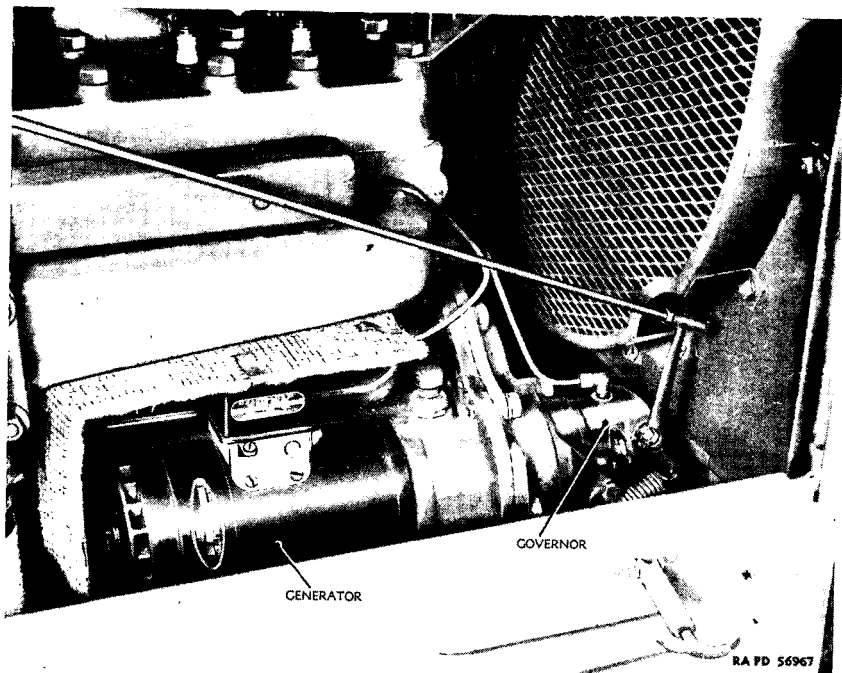
(2) REMOVE HOLD-DOWN CLAMPS AND BATTERY. Loosen nut on battery hold-down clamps, and remove clamps and battery.

**e. Installation.**

(1) INSTALL BATTERY. Place battery in battery tray with the negative pole closest to the center housing upright.

(2) CONNECT TERMINALS. Connect lead grounded on upright to the negative pole of battery. Connect lead from starter button to positive pole of battery.

ENGINE ELECTRICAL SYSTEM



**Figure 61—Battery-Charging Generator**

(3) **INSTALL HOLD-DOWN CLAMPS.** Adjust hold-down clamps at each end of battery, and fasten nuts and lock washers to hold clamps securely.

**76. BATTERY-CHARGING GENERATOR (fig. 61).**

**a. Construction.** The battery-charging generator is a 2-pole, shunt-wound, third-brush regulated, ventilated unit with a capacity of 6 volts. A 2-charge voltage regulator is mounted on the generator frame, and combines the cut-out with the regulator. A 5-ampere fuse (fig. 64) is mounted in the regulator.

**b. Functioning.** The generator produces current for charging the battery. The regulator allows the generator to charge at its high rate until the battery is nearly charged, and has reached a predetermined voltage, at which time a resistance is cut into the field circuit of the generator, reducing the charging rate approximately one-half. The cut-out acts as an automatic switch between the generator and the battery, closing the circuit when the generator is producing sufficient output to charge the battery, and opening the circuit when the generator is not charging, so as to prevent the battery from discharging back through the generator.

## GENERATING UNIT M7

### c. Trouble Shooting.

#### (1) BURNT-OUT FUSE.

Possible Cause	Possible Remedy
Stuck relay creates short from overcharging.	Replace relay and fuse.

#### (2) GENERATOR FAILS TO CHARGE.

Brushes burned out or worn out. Replace brushes.

#### (3) LOW CURRENT OR NO CURRENT.

Open circuit in brush connections. Replace brushes.

Brush sticks in holder. Loosen and place on commutator.

Open circuit due to dirty commutator. Clean commutator.

#### (4) NOISE AT ENGINE IDLING SPEED.

Noisy bearing. Notify ordnance personnel.

Loose pulley. Tighten pulley.

Loose pole piece. Tighten pole piece.

### d. Maintenance.

(1) To inspect the battery-charging generator, remove the cover at the commutator end. If the commutator is discolored or dirty, it can be polished by holding a piece of PAPER, flint, class B, grade No. 2/0, against it while the generator is running slowly.

#### (2) BRUSHES.

(a) If brushes are badly worn, new brushes should be installed. The brushes should be fitted to have at least 80 percent brush surface contact with the commutator. To seat the brushes, clean the commutator (step (1), above), then wrap around the commutator a piece of PAPER, flint, class B, grade No. 2/0, of the same width as the commutator, and move it back and forth along the commutator with sanded face against brushes. Turn the commutator clockwise from drive end until brushes seat properly. Blow the generator out with compressed air to remove all particles of abrasive. Use only PAPER, flint, class B, grade 40, to seat brushes.

(b) Brush spring tension can be tested by hooking a scale in the hole at the end of the brush arm, and taking a reading as the arm leaves the brush. The tension for all three brushes, when new, should not be more than 53 ounces maximum.

(c) The charging rate of the generator is controlled by a third brush that is adjustable. Advance or retard the third brush as required. Moving the brush in direction of rotation increases the charging rate, while moving it against armature rotation decreases the charging rate.

#### (3) BATTERY-CHARGING GENERATOR BRUSH REPLACEMENT.

(a) *Remove Cover Strip.* Unscrew bolt holding cover strip in place, and remove strip.

ENGINE ELECTRICAL SYSTEM

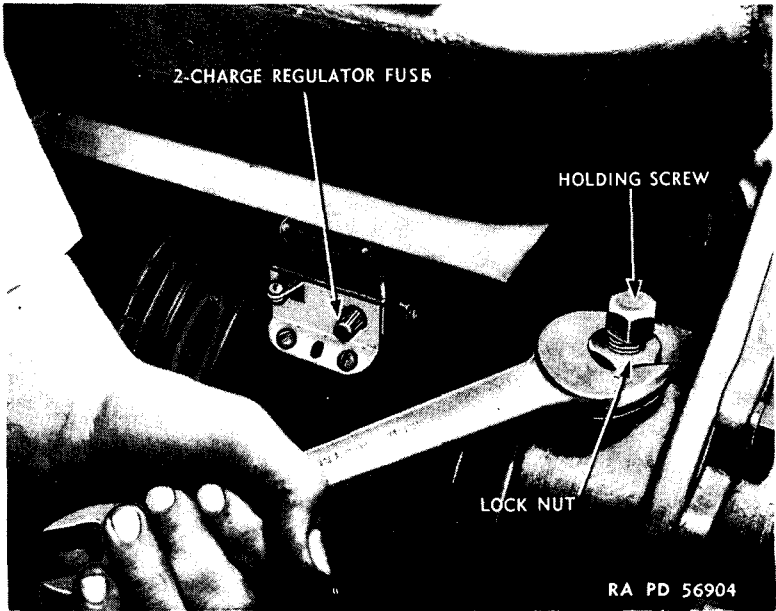


Figure 62—Loosening Battery-Charging Generator Holding Screw

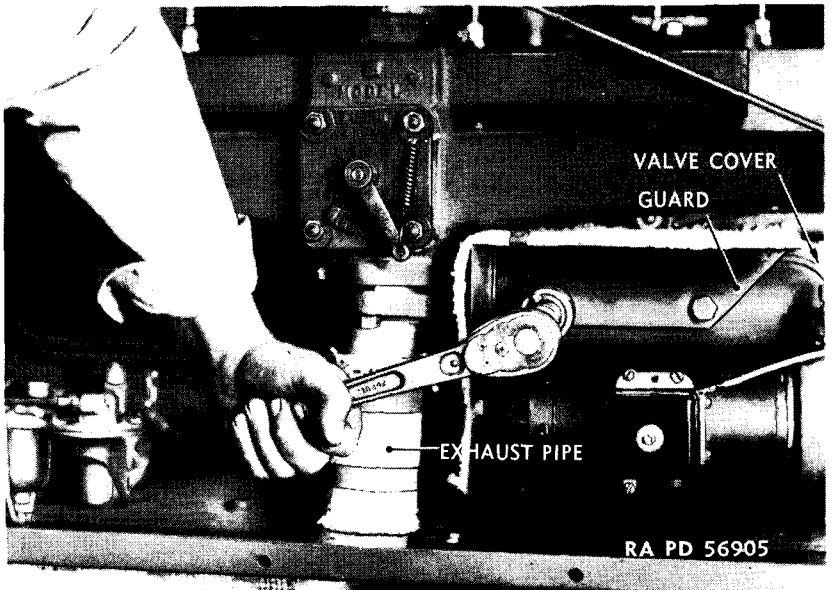
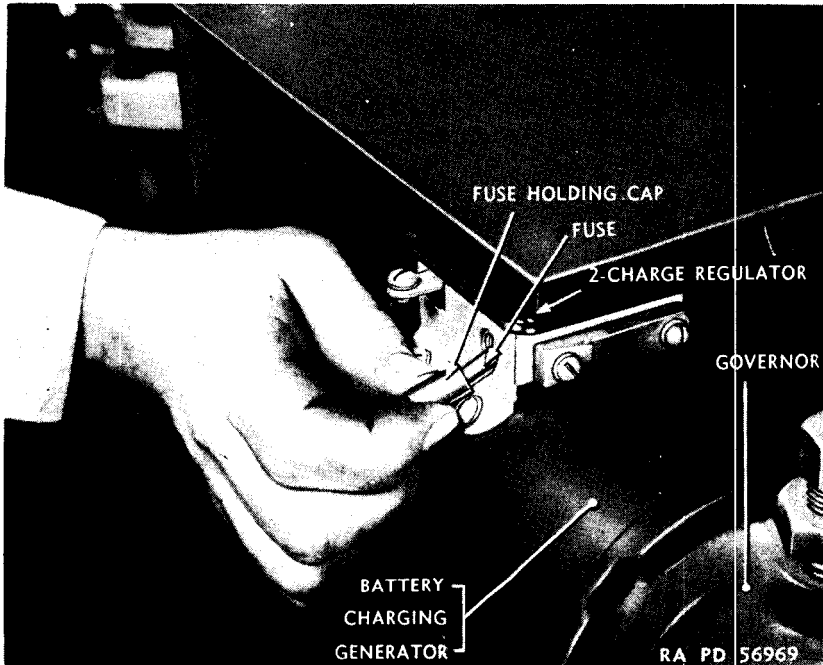


Figure 63—Battery-Charging Generator Guard Removal



GENERATING UNIT M7



**Figure 64—Voltage Regulator Fuse**

(b) **Remove Brushes and Replace.** Take out screws attaching brush leads. Hold back spring clips and remove brushes. Put new brushes in position under clips, attach leads, and replace cover strip.

**e. Removal.**

(1) **REMOVE GUARD PLATE** (fig. 47). Loosen lock nut on holding cap screw (fig. 62) that goes through generator housing to secure generator in place. Loosen cap screw. Turn generator until the regulator is at the front, and the cap screws holding the metal guard are accessible. Remove cap screws attaching guard to cylinder chamber cover plate and the engine.

(2) **REMOVE GENERATOR.** Take out screw that holds lead to the 2-charge regulator. The loosened generator will now be removed.

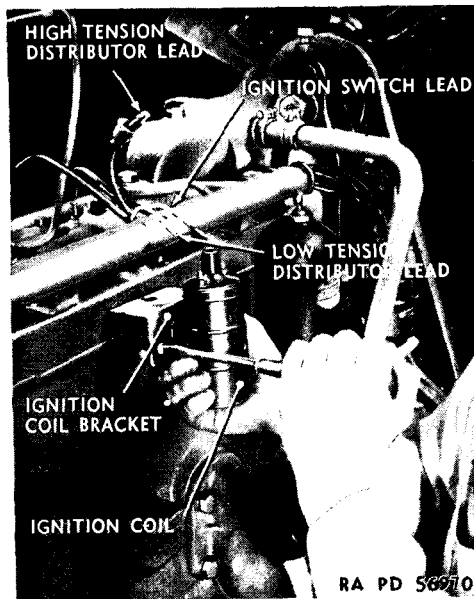
**f. Installation.**

(1) **INSERT GENERATOR IN HOUSING AND CONNECT LEAD.** Place generator in position in housing, and connect lead.

(2) **ATTACH GUARD.** Place cylinder compartment cover plate in position, and attach guard plate by cap screws through guard and cover plate.

(3) **SECURE GENERATOR IN PLACE.** Turn generator in housing until the 2-charge regulator is at the top, under the guard. Tighten holding cap screw and secure with lock nut.

**ENGINE ELECTRICAL SYSTEM**



**Figure 65—Ignition Coil Removal**

**77. IGNITION COIL.**

**a. Construction.** The ignition coil consists of a primary and a secondary winding, mounted upon a common magnetic core.

**b. Functioning.** The ignition coil is a current transformer that takes the 6-volt current, and by induction, builds it up to the voltage required for the ignition spark.

**c. Trouble Shooting.**

(1) **NO SPARK OR INADEQUATE SPARK.**

Possible Cause	Possible Remedy
Ignition coil faulty.	Replace coil.

**d. Maintenance.**

(1) The ignition coil is a totally enclosed unit that needs no special attention. Connections and terminals should be kept clean and tight.

(2) If coil is thought to be faulty, substitute another coil known to be in good condition, and check engine operation.

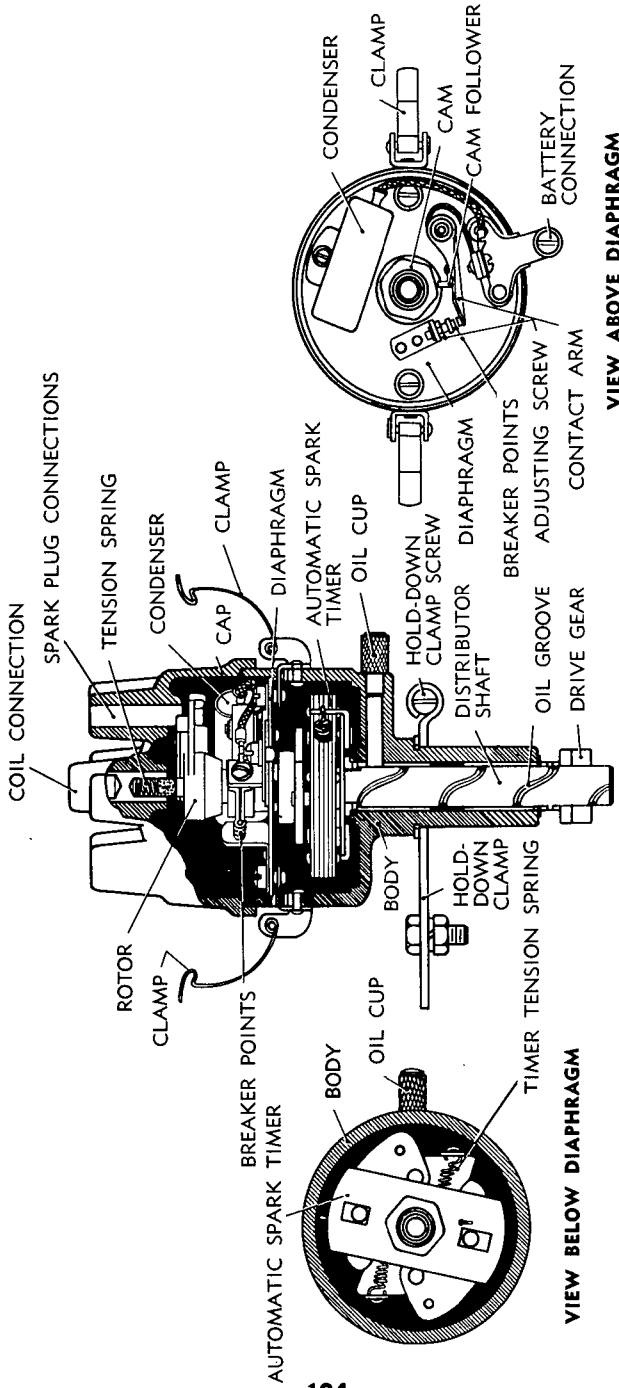
**e. Removal.**

(1) **REMOVE COIL** (fig. 65). Disconnect center snap-on lead, and leads from distributor and ignition switch, and unscrew bolts, nuts, and lock washers holding ignition coil collar to bracket. Remove coil.

**f. Installation.**

(1) **INSTALL COIL.** Attach coil to bracket with collar secured by bolts, lock washers, and nuts.

GENERATING UNIT M7



RA PD 56971

Figure 66 — Distributor Diagrams

**ENGINE ELECTRICAL SYSTEM**

(2) **CONNECT LEADS.** Attach center snap-on lead and side leads from distributor and ignition switch.

**78. DISTRIBUTOR** (fig. 66).

**a. Construction.** The distributor is a 6-cylinder, automatic, single breaker arm type which contains the battery circuit contact points, automatic advance mechanism, and high-tension distributor. A condenser is set across the lines.

**b. Functioning.** The rotor makes contact between the spark plug connected points in the cover and the ignition coil line. The breaker interrupts the current in the primary line of the ignition coil, which induces high-tension current in the secondary. The condenser cushions the shock of the interrupted current, and prevents burning of the breaker points.

**c. Trouble Shooting.**

(1) **ENGINE WILL NOT START.**

Possible Cause	Possible Remedy
Breaker points defective.	Replace points.
Breaker arm grounded.	Replace arm.
Defective cap.	Replace cap.
Defective rotor.	Replace rotor.

(2) **POOR STARTING OR ENGINE MISSING.**

Breaker points carbonized.	Clean breaker points.
Breaker points gummy.	Clean breaker points.
Breaker points badly worn or pitted.	Resurface, or install new breaker arm and points.

(3) **ENGINE "PINGING" OR BACKFIRING THROUGH CARBURETOR.**

Distributor too far advanced. Report to ordnance personnel.

(4) **ENGINE HESITATES IN STARTING, BACKFIRES THROUGH EXHAUST, OR EXHAUST MANIFOLD GETS EXCESSIVELY HOT.**

Distributor too far retarded. Report to ordnance personnel.

(5) **DISTRIBUTOR CAP SPARKS FROM LEADS TO SPARK PLUGS.**

Cracked distributor cap. Replace cap.

(6) **ENGINE MISSES AT LOW SPEED.**

Breaker point gap too small. Adjust gap.

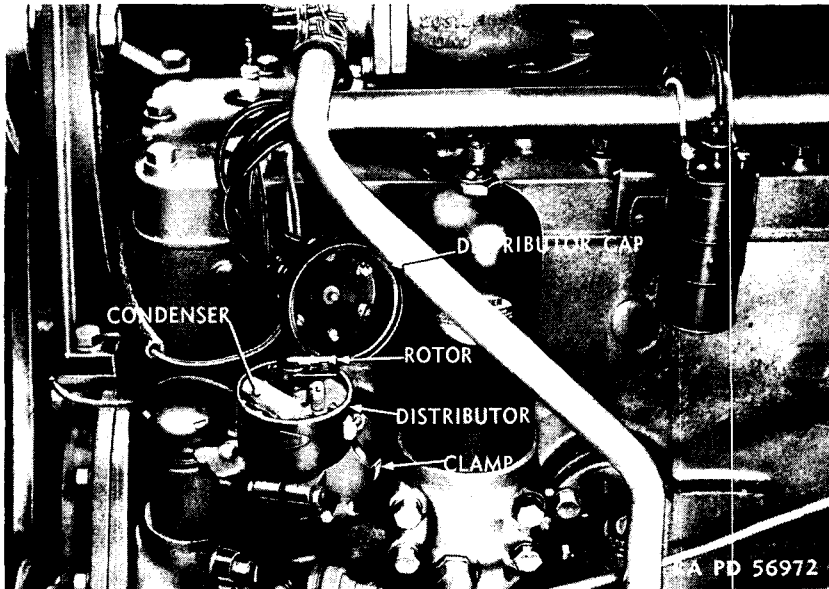
(7) **ENGINE MISSES AT HIGH SPEED UNDER LOAD.**

Breaker point gap too large. Adjust gap.  
Breaker arm spring tension too weak. Replace arm.

(8) **ENGINE MISSES AT ALL SPEEDS.**

Breaker contact points too far apart. Adjust.  
Breaker contact points pitted. Replace breaker arm and screw point.  
Breaker point screw loose. Tighten screw.

## GENERATING UNIT M7



**Figure 67—Distributor—Cap Removed**

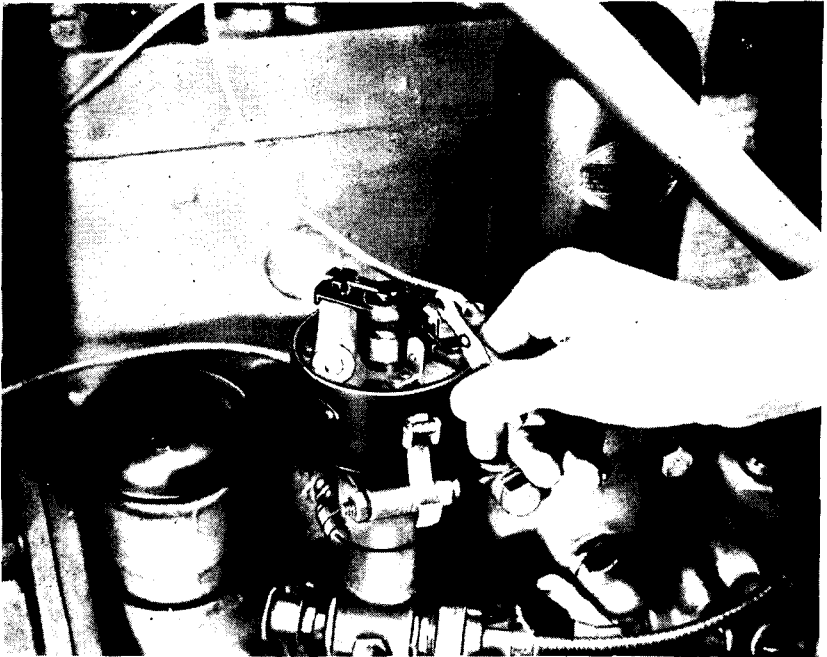
**d. Maintenance.**

(1) **DISTRIBUTOR CAP.** The distributor cap (fig. 67) must be kept clean and should be constantly inspected for cracks, carbon runners, evidence of arcing, or corroded high-tension terminals. If any of these conditions are present, the cap should be replaced. After a distributor cap has had normal use, the inside of the cap inserts will become slightly burned. If these inserts are badly burned at any other point, the cap should be replaced.

(2) **ROTOR.** The rotor should be inspected for cracks. If cracks are found, it should be replaced. After a rotor has had normal use, the end of the contact will become burned. If this burning is not excessive, and is found only on the end of the metal strip, the rotor need not be replaced. If burning is found on the top of the strip, it indicates the rotor is too short, and needs replacing. Usually when this condition is found, the distributor cap inserts will be burned on their horizontal face, and the cap also will need replacing.

(3) **BREAKER POINTS.** If breaker points are in good condition, they will show a grayish color with no evidence of burning or pitting. Breaker points should be so alined as to make contact over the whole area of the contact surfaces. Breaker point gap should be 0.020 inch  $\pm$  0.002 inch. If alinement is not correct, bend the stationary point bracket to secure proper alinement, and then adjust the gap (fig. 68),

**ENGINE ELECTRICAL SYSTEM**



RA PD 56973

**Figure 68—Gaging Breaker Points**

and tighten the lock nut. Breaker point pressure should be 17 to 20 ounces. Check with spring scale hooked on the breaker arm at the point, and pull on a line perpendicular to the breaker arm. Take the reading just as the points separate. Adjust the point pressure by loosening the screw holding the end of the contact arm spring and sliding the end of the spring in and out as necessary.

(4) **CONDENSER.** The condenser should be checked for broken wires, frayed insulation, and firm mounting. See that connections are clean and tight.

**e. Condenser Removal.**

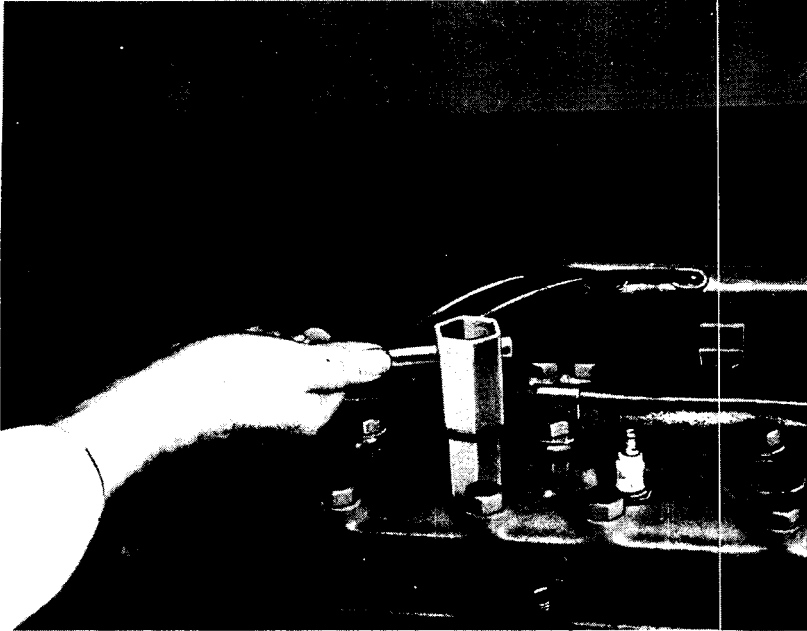
(1) Snap down the two distributor cap springs and lift off distributor cap (fig. 67). **NOTE:** Do not remove any wires from the distributor cap.

(2) Lift rotor up from the shaft, and remove.

(3) Remove screw securing condenser lead and breaker arm to breaker plate.

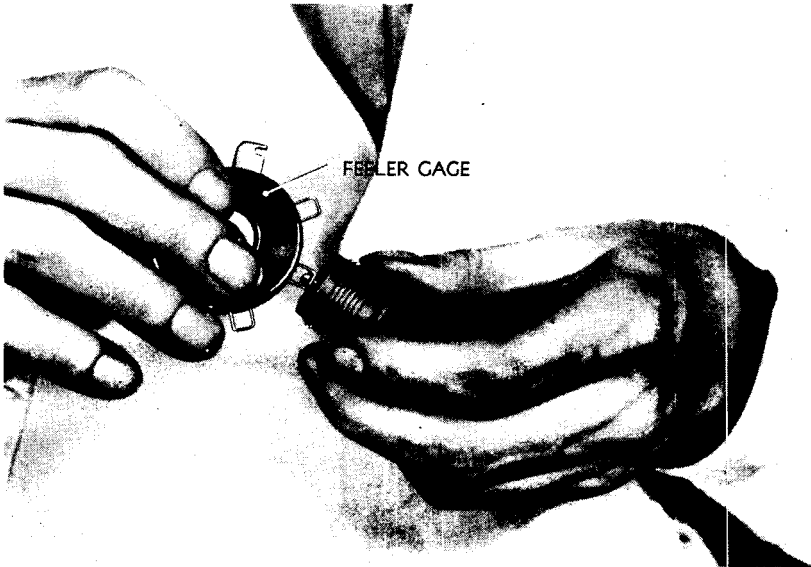
(4) Remove screw securing condenser to breaker plate, and lift out condenser.

GENERATING UNIT M7



RA PD 56907

*Figure 69—Spark Plug Removal*



RA PD 56908

*Figure 70—Gaging Spark Plug Gap*  
108

## ENGINE ELECTRICAL SYSTEM

### f. Condenser Installation.

(1) Place condenser in position on breaker plate in distributor, and secure with machine screw.

(2) Connect condenser lead to breaker plate terminal with screw securing breaker arm to breaker plate terminal.

(3) Place rotor in position over distributor shaft. Distributor shaft is cut so that it is possible to put rotor on shaft in one position. Check position rotor is to be inserted to avoid breaking rotor.

(4) Place distributor cap on distributor, and secure in position with the two distributor cap springs.

## 79. SPARK PLUGS.

a. **Description.** The spark plugs are of the commercial automotive type with electrode gap adjustments made by bending the side electrode. Each plug consists of a metal shell within which is fixed an insulator with a central electrode stem. The metal shell is threaded to screw into the engine cylinder head. The central electrode stem is threaded at the upper part of the insulator to provide means of attaching the high tension lead from the distributor. Champion No. 1 common, or equivalent spark plugs are used. These plugs are a cold-type, and under no circumstances should they be replaced with hot-type plugs.

b. **Functioning.** When the circuit from the ignition coil to the spark plug is closed, a spark jumps across the spark plug electrode gap and ignites the gas mixture in the combustion chamber.

c. **Trouble Shooting.** Cracked, dirty, or improperly adjusted spark plugs cause poor engine performance. To determine if faulty engine performance is caused by one or more faulty spark plugs, start engine and set speed slightly above idling. Short out each spark plug with a wood-handle screwdriver, by holding the screwdriver bit against the spark plug terminal and engine cylinder head. **NOTE:** Do not touch metal part of screwdriver as an unpleasant shock will be felt. If there is noticeable difference in the engine performance, the shorted spark plug can be assumed to be in good condition. If, however, there is no noticeable difference in engine performance, the shorted spark plug should be renewed. If the installation of new spark plugs does not improve engine performance, fault must be found elsewhere in the ignition system, in the fuel system, or a mechanical defect exists in the engine.

d. **Maintenance.** Remove spark plugs after each 100 hours of operation, and make the following check.

(1) Check for cracked or blistered insulations, and replace plugs if any is evident.

(2) Check for dirty electrodes and insulations. Thoroughly clean each dirty spark plug in sand blast spark plug cleaner.



## GENERATING UNIT M7

(3) Check for worn electrodes. Replace spark plugs with worn electrodes.

(4) Check and adjust spark plug electrode gap using 0.025 feeler on gage (fig. 70). Bend outside electrode with pliers to obtain correct gap. Never bend inside electrode.

(5) Test each spark plug on a spark plug tester to assure proper performance.

e. **Removal.** Unsnap high tension lead from the spark plug terminal, and using a spark plug wrench (fig. 69), unscrew spark plug from cylinder head. Lift off spark plug gasket with spark plug.

f. **Installation.** Place copper gasket over threaded portion of the spark plug shell, and screw spark plug into cylinder using spark plug wrench. Avoid excessive pressure when tightening spark plugs. Attach proper high tension lead to spark plug terminal.

### 80. STARTING MOTOR.

a. **Construction.** The starting or cranking motor is a heavy-duty 4-brush, Bendix drive type. It is located at the lower left side of the engine, and secured to the engine bell housing. The right-hand outboard Bendix drive transmits power to the engine flywheel ring gear (fig. 72). A removable head band gives access to commutator and brushes.

b. **Functioning.** As the motor starts, the Bendix gear moves into mesh with the flywheel ring gear, and rotates the engine flywheel and crankshaft. As soon as the engine starts to run, the Bendix gear retracts until it is out of mesh with the flywheel ring gear.

#### c. Trouble Shooting.

##### (1) FAILS TO OPERATE.

Possible Cause	Possible Remedy
Battery discharged.	Recharge battery.
Loose or dirty connections.	Clean and tighten connections.
Bendix gear jammed.	Free gear from flywheel.
Starting motor switch faulty.	Replace switch.
Bendix drive at fault.	Repair starter.

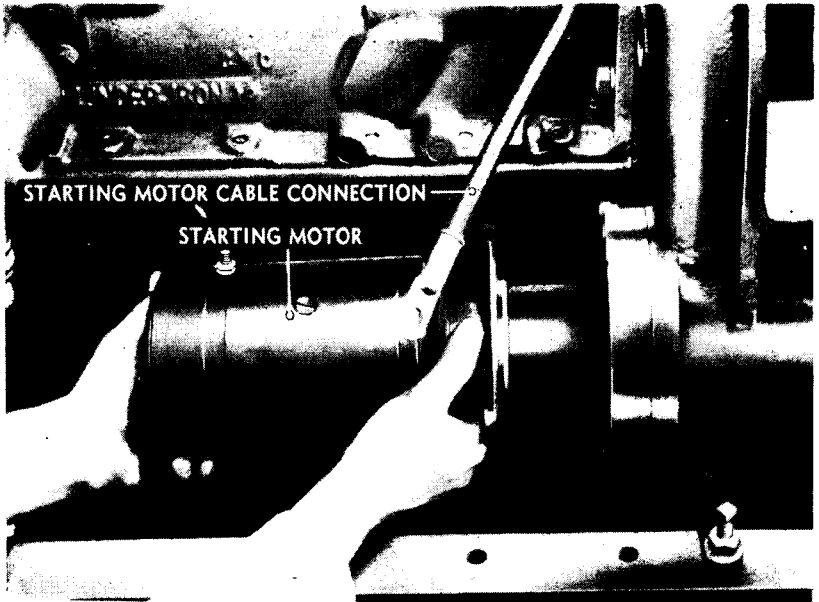
##### (2) STARTING MOTOR CRANKS WEAKLY.

Battery weak.	Recharge battery.
Loose or dirty connections.	Clean and tighten connections.
Commutator dirty.	Remove band and clean commutator with PAPER, flint, class B, No. 2/0.
Starting motor faulty.	Replace.

##### (3) BENDIX DRIVE FAILS TO OPERATE WHEN STARTING MOTOR REVOLVES.

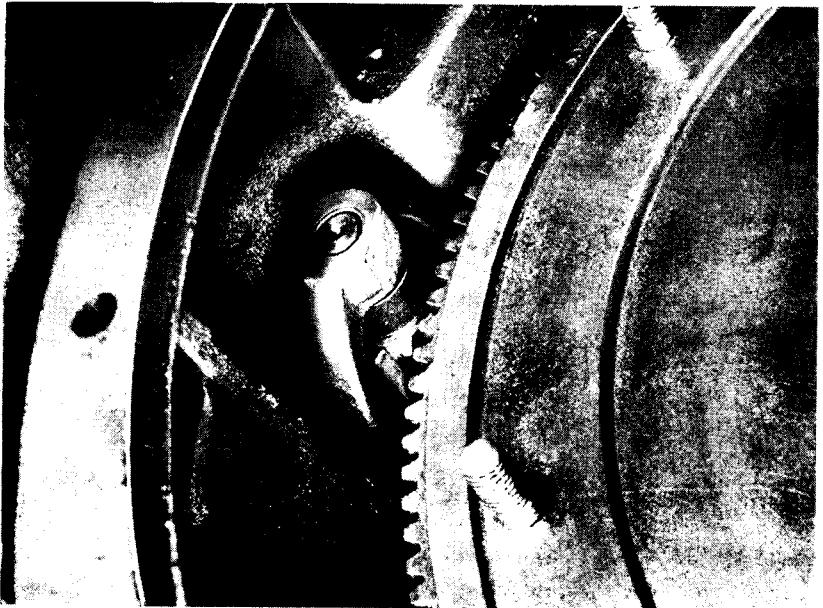
Dirty or gummy Bendix drive.	Remove starting motor. Clean and lubricate drive.
------------------------------	---

ENGINE ELECTRICAL SYSTEM



RA PD 84573

**Figure 71—Starting Motor Removal**



RA PD 56978

**Figure 72—Starting Motor Drive and Flywheel**

GENERATING UNIT M7

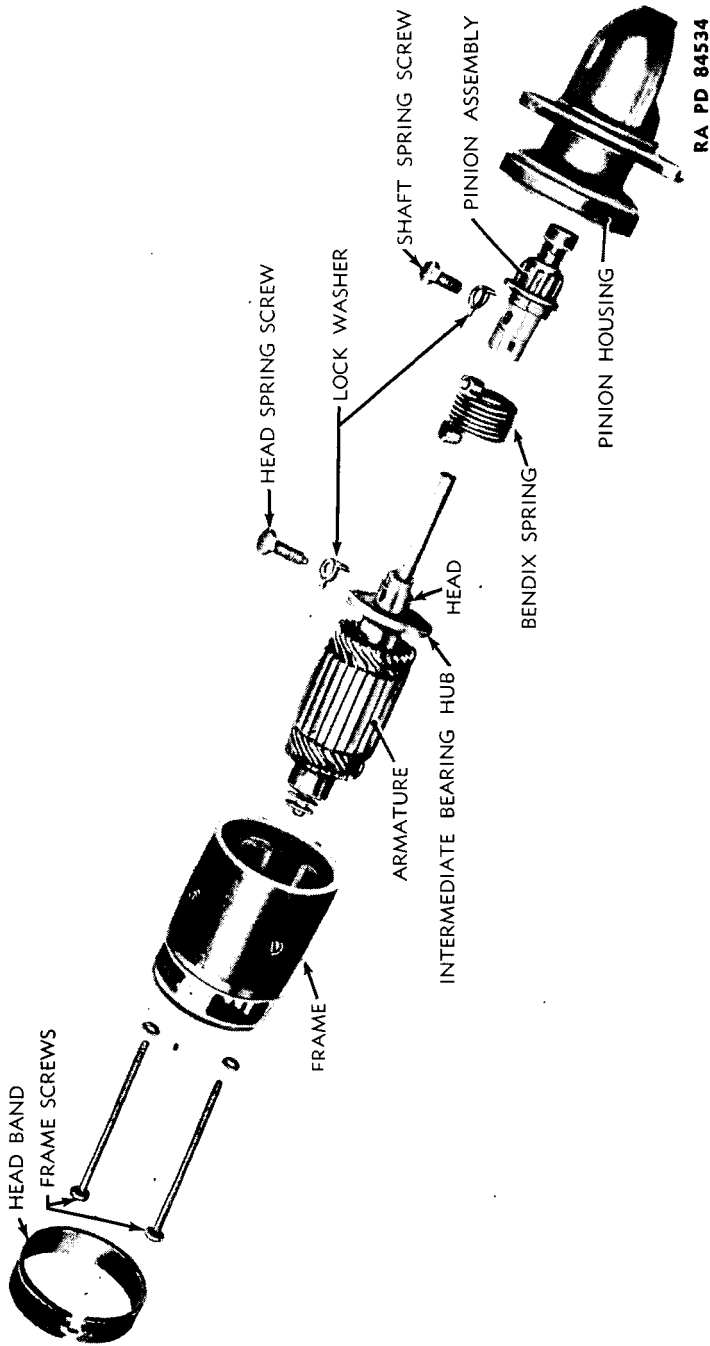


Figure 73—Starting Motor Bendix Spring Removal

## ENGINE ELECTRICAL SYSTEM

### d. Maintenance.

(1) The cover band should be removed periodically, and the brushes and commutator inspected. If brushes wear excessively, check for excessive brush spring tension and for roughness or high mica of the commutator. Check for loose flange mounting screws and oil seepage into the drive from the engine bell housing.

#### (2) STARTING MOTOR BRUSH REPLACEMENT.

(a) *Remove Head Band.*

(b) *Remove Brushes and Replace.* Take out screws holding brush leads. Hold back clips, and remove brushes. Put new brushes in position under clips, and attach leads.

(c) *Replace Head Band.* Place head band back in position, and secure with holding bolt, lock washer, and nut.

### e. Removal (fig. 71).

(1) **DISCONNECT LEAD.** Remove nut attaching starter switch lead to post on the frame of the starting motor.

(2) **REMOVE MOTOR.** Take out three cap screws and lock washers holding motor to front of bell housing and lift off starting motor.

### f. Installation.

(1) **INSTALL STARTING MOTOR.** Place motor in position on front of bell housing, securing it with the three cap screws and lock washers.

(2) **ATTACH STARTER LEAD.** Bring lead from starter switch to post on frame of starting motor, and attach with nut provided.

### g. Bendix Spring Removal (fig. 73).

(1) Remove starting motor (step e, above).

(2) Loosen head band clamp screw, and remove commutator end head band.

(3) Remove the two frame screws, and pull pinion housing and armature from starting motor frame. Do not separate commutator end head from frame.

(4) Slide pinion housing from armature shaft.

(5) Bend down the lip on each lock washer, and remove head spring screw and shaft spring screw.

(6) Slide pinion assembly off armature shaft, and lift off Bendix spring.

### h. Bendix Spring Installation (fig. 73).

(1) Thoroughly clean Bendix drive parts in SOLVENT, dry-cleaning, and apply a few drops of OIL, engine, SAE 10 to armature shaft, pinion shaft, and armature shaft bearings.

(2) Slide Bendix spring and pinion assembly in position over armature shaft. Using a lock washer (special) over each screw, secure spring to head and armature shaft, using head spring screw (doweled).

**NOTE:** Doweled portion of head spring screw must enter hole in armature shaft. Secure spring to pinion assembly using shaft spring screw. Lock screws by bending up the lip on each lock washer.

### GENERATING UNIT M7

(3) Assemble armature shaft with attached Bendix drive assembly into pinion housing, so that intermediate bearing hub slot lines up with the dowel in housing. Push hub into position on housing. Rotate armature to test if the armature bearings are lined up. The armature should rotate freely.

(4) Lift up on the four brushes, and, with thrust washers over shaft on commutator end of armature, push armature through starting motor frame, so that shaft enters end head bearing. Release brushes.

(5) Attach commutator end head and pinion housing to frame, using the two frame screws.

(6) Place head band over commutator end head, and secure in position with clamp screw.

(7) Install starting motor (step f, above).

## Section XV

### GENERATING SYSTEM

	Paragraph
Description .....	81
Trouble shooting .....	82
Alternator description .....	83
Alternator trouble shooting .....	84
Alternator maintenance .....	85
Exciter description .....	86
Exciter trouble shooting .....	87
Exciter maintenance .....	88
200-ampere power receptacle .....	89
30-ampere power receptacle .....	90

#### 81. DESCRIPTION (fig. 74).

a. **Construction.** The generating system is made up of the alternator, the exciter, a rheostat on the exciter line, a load switch, an ammeter for registering the amperage of the current delivered, a voltmeter for registering the voltage, a meter switch to connect each of the phases of the circuit with the ammeter and voltmeter, two light sockets, a toggle switch with a lamp-dimming rheostat to control them, two power receptacles, T-slot receptacles, and fuses.

b. **Functioning.** The engine, directly coupled to the alternator shaft, turns the alternator rotor and (through a V-belt) the exciter armature, or by direct connection on the alternator shaft in the case of the H. B. Co. unit. The exciter supplies the alternator field current

## GENERATING SYSTEM

as required by the load. The exciter field rheostat may be used to maintain constant alternator output voltage under varying loads. The load switch completes or interrupts the load circuit from the alternator to the two power receptacles. Five T-slot receptacles and two lamp sockets are fed from the line ahead of the load switch. The lamps are controlled by a toggle switch, and the illumination given is controlled by a dimming rheostat.

### 82. TROUBLE SHOOTING.

#### a. Failure to Build up Voltage.

Possible Cause	Possible Remedy
Loose connections.	Check, and tighten all connections.
Reversed field connections.	Interchange connections "F <sup>1</sup> " and "F <sup>2</sup> " at terminal block.
Absence of residual magnetism.	Lift alternator brushes for a few moments while it is running. If voltage does not then build up, excite field for a moment in proper direction with exciter brush raised, using an outside source such as a battery.
Reversed polarity.	Same as above.
Collector ring brushes not making proper contact.	Increase spring pressure, and clean brush holders.
Exciter belt slipping.	Tighten belt.
Burnt-out exciter windings.	Report to ordnance personnel.
Burnt-out alternator windings.	Report to ordnance personnel.
Open circuit in field rheostat.	Report to ordnance personnel.

#### b. Excessive Sparking at Exciter Brushes.

Dirty or pitted commutator.      Clean or dress commutator.

#### c. Excessive Sparking at Slip Rings.

Dirty or pitted slip rings.      Clean or dress slip rings.

#### d. Excessive Heating of Alternator.

Overload.      Decrease load to allowable limit.  
Grounded or open stator coils.      Report to ordnance personnel.

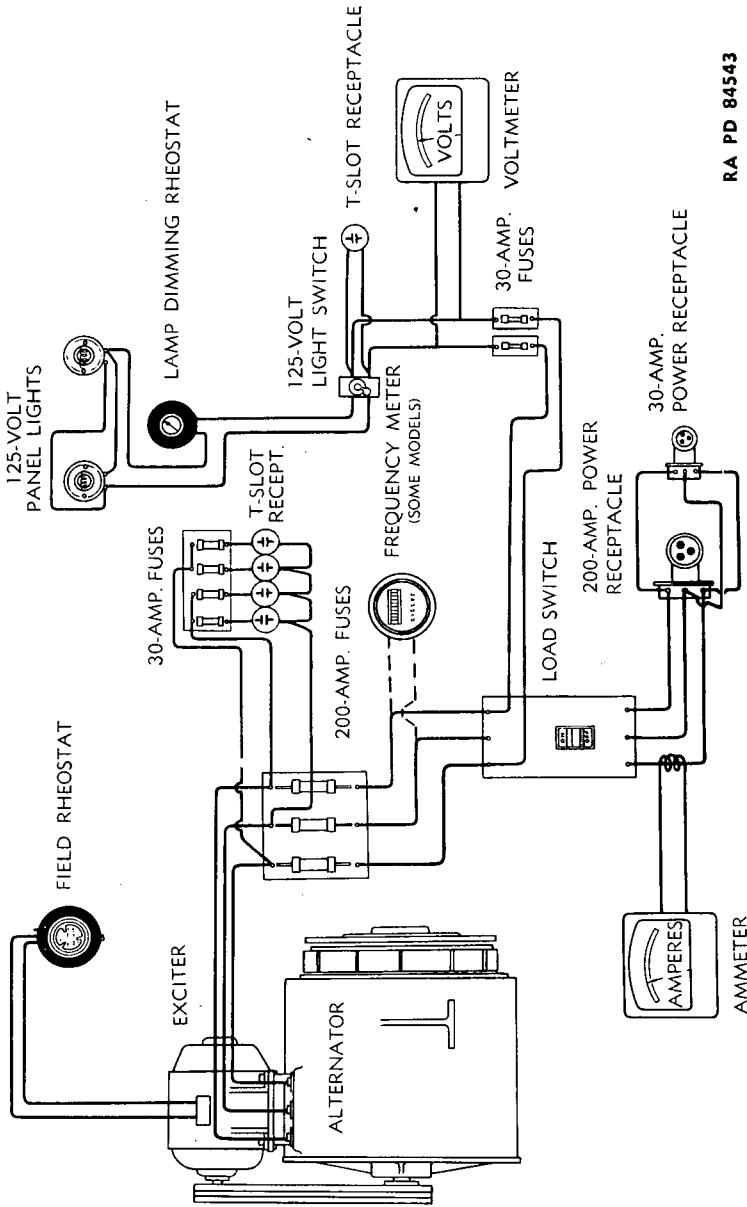
#### e. Excessive Heating of Exciter.

Open circuit in armature coil.      Report to ordnance personnel.  
Grounded commutator.      Report to ordnance personnel.

#### f. Excessive Noise in Alternator.

Broken bearings.      Report to ordnance personnel.  
Coupling failure.      Report to ordnance personnel.  
Worn-out brushes.      Replace brushes.  
Damaged brush springs.      Replace springs.

GENERATING UNIT M7



RA PD 84543

Figure 74—Generating System

**GENERATING SYSTEM**

**g. Excessive Noise in Exciter.**

Possible Cause	Possible Remedy
Broken bearings.	Report to ordnance personnel.
Commutator damaged.	Report to ordnance personnel.
Improperly fitted brushes.	Fit brushes properly.
Worn-out brushes.	Replace brushes.
Damaged brush springs.	Replace springs.

**83. ALTERNATOR DESCRIPTION.**

**a. Construction.** The alternator is an electric a-c generator connected to the engine by means of a flexible coupling. It is semiprotected type and is self-ventilated.

**b. Functioning.** The alternator, in combination with the exciter, takes the mechanical energy of the engine and transforms it into electrical energy by magnetic induction. When driven at its rated speed, the alternator, with its field energized by the exciter, produces a voltage at its terminals equivalent to that provided by the usual 125-volt lighting circuit. This voltage can be varied over a range of 90 to 150 volts by the use of the field rheostat.

**84. ALTERNATOR TROUBLE SHOOTING.**

**a. Failure to Build up Voltage.**

Possible Cause	Possible Remedy
Loose connections.	Check and tighten all connections.
Absence of residual magnetism.	Lift alternator brushes for a few moments while it is running. If voltage does not then build up, excite field for a moment in proper direction with exciter brush raised, using an outside source, such as a battery.
Reversed polarity.	Same as above.
Collector ring brushes not making proper contact.	Increase spring pressure, and clean brush holders.
Damaged brush springs.	Replace springs.
Burnt-out windings.	Report to ordnance personnel.
Worn-out brushes.	Replace brushes.

**b. Excessive Sparking at Slip Rings.**

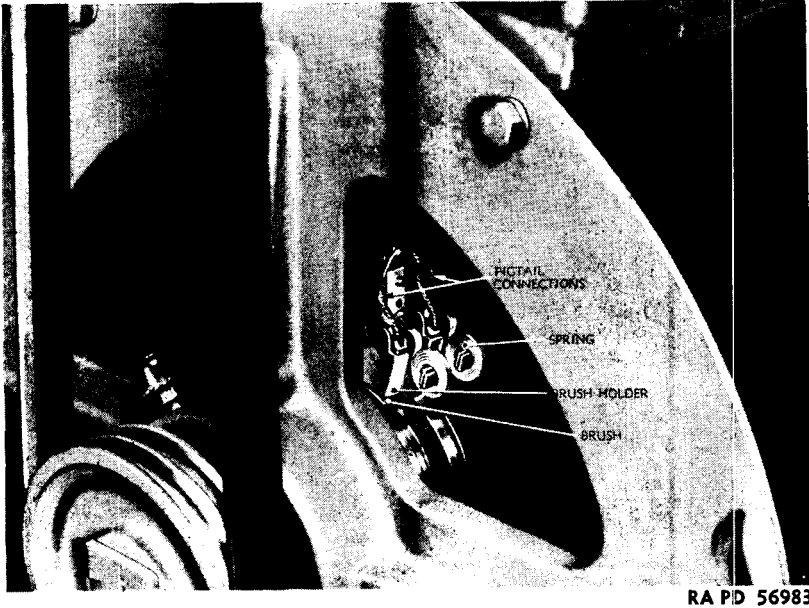
Dirty or pitted slip rings.      Clean or dress slip rings.

**c. Excessive Heating.**

Overload.      Decrease load to allowable limit.  
Grounded or open stator coils.      Report to ordnance personnel.

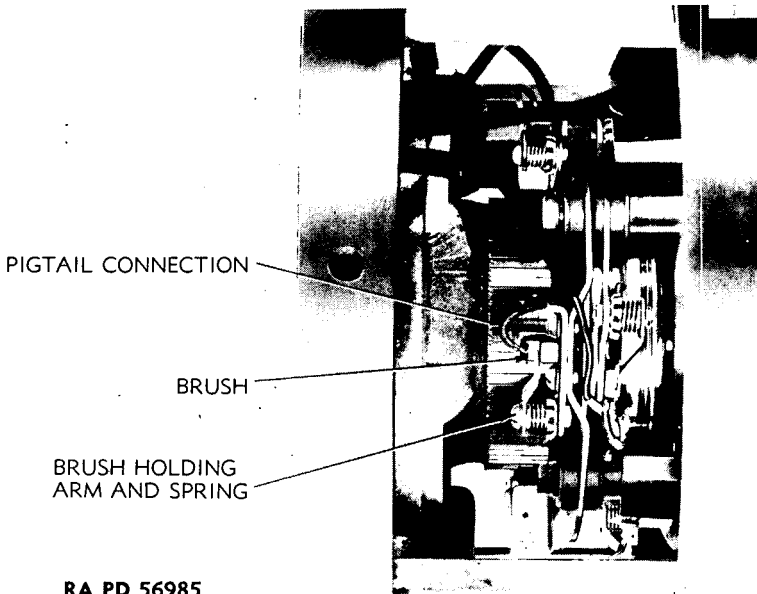


GENERATING UNIT M7



RA PD 56983

**Figure 75—Alternator—Showing Springs, Brushes and Brush Holders**



RA PD 56985

**Figure 76—H. B. Co. Unit—View Through Exciter and Alternator Brush Holder Ring**

## GENERATING SYSTEM

### d. Excessive Noise.

Possible Cause	Possible Remedy
Broken bearings.	Report to ordnance personnel.
Loose or damaged brush springs.	Tighten or replace brush springs.
Coupling failure.	Report to ordnance personnel.
Worn or improperly fitting brushes.	Fit brushes properly, or replace.

## 85. ALTERNATOR MAINTENANCE.

a. **Brush Inspection.** Alternator brushes (fig. 75) should be inspected at least every 3 months. If gummy and stuck in brush holders, they should be removed and cleaned. All brush holder supports should also be cleaned. Screws holding pigtail connections should be tight. Brush holder box should not be less than  $\frac{1}{10}$  inch nor more than  $\frac{1}{8}$  inch from collector rings.

b. **Brush Removal.** Loosen screw holding pigtail connection, and slide connection lug out from under screw. Lift brush spring from brush, and remove brush.

c. **Brush Installation.** Slide pigtail connection lug under screw, and tighten screw. Place brush in holder, and set spring on top to keep brush tight against collector ring.

d. **Brush Spring Inspection.** Brush springs are designed to give a minimum pressure of 8 ounces per brush. This pressure is not critical on collector rings, and spring pressure will be maintained indefinitely unless brush pigtail circuit opens and brush spring carries exciting current. If so, it will lose its temper, and should be replaced. To check brush spring pressure, hook spring scale under at point where it bears on brush, and pull in direction of brush travel in brush holder, until finger is just lifted off brush.

e. **Brush Spring Removal (Units Other than H. B. Co.).** Pry apart the jaws of the spring-holding clamp, and remove spring.

f. **Brush Spring Installation (Units Other than H. B. Co.).** Pry apart the jaws of the spring-holding clamp and slide the spring in. Place the free end of the spring on top of the brush.

g. **Brush Spring Removal (H. B. Co. Unit) (fig. 76).**

(1) **REMOVE COVER.** Take out machine screws, nuts, and lock washers holding louvered, sheet metal cover on exciter bearing bracket.

(2) **REMOVE SPRING HOLDER ASSEMBLY.** Hold nut, and remove bolt, washer, tension arm sleeve, spring adjusting washer, and spring.

h. **Brush Spring Installation (H. B. Co. Unit).** Assemble bolt and washer through tension arm sleeve. Set spring adjusting washer over spring. Carry bolt through brush holding flange, hold nut, and tighten bolt.

i. **Collector Ring Inspection.** Collector rings should be inspected periodically to see if they are smooth and glossy. Use of extremely hard brushes, presence of grit or other abrasive material which may

## GENERATING UNIT M7

become embedded in the brushes, or presence of oil in the rings or brush surfaces will result in grooving or roughening of the rings. If roughened, the rings should be smoothed by running the unit at a slow speed and applying PAPER, flint, class B, grade No. 2/0, with moderate pressure. If very badly worn, collector rings should be replaced, but this operation is not within the scope of this manual.

### 86. EXCITER DESCRIPTION.

a. **Construction.** The exciter is a d-c generator connected to the alternator shaft by V-belts.

b. **Functioning.** The exciter supplies direct, or excitation, current to the field coils of the alternator. It has a rated output of 1 kw, 62.5 volts, 16 amp, at 1,800 rpm, with a maximum temperature rise of 40 degrees C.

### 87. EXCITER TROUBLE SHOOTING.

#### a. Failure to Build up Voltage.

Possible Cause	Possible Remedy
Loose connections.	Check and tighten all connections.
Exciter belt slipping.	Tighten belt.
Burnt-out exciter windings.	Report to ordnance personnel.
Exciter brushes not making proper contact with commutator.	Increase spring pressure.

#### b. Excessive Sparking at Exciter Brushes.

Dirty or pitted commutator.	Clean or dress commutator.
-----------------------------	----------------------------

#### c. Excessive Heating of Exciter.

Open circuit in armature coil.	Report to ordnance personnel.
Grounded commutator.	Report to ordnance personnel.

#### d. Excessive Noise in Exciter.

Broken bearings.	Report to ordnance personnel.
Commutator damaged.	Report to ordnance personnel.
Improperly fitted brushes.	Fit brushes properly.

### 88. EXCITER MAINTENANCE.

a. **Brush Inspection.** Exciter brushes should be inspected periodically for wear, proper spring pressure, and freedom in the holders. If stuck with dirt or other foreign substance, they should be removed and cleaned. Brush holders and brush holder rod insulating washers should be carefully cleaned at this time. Pigtail connections should be tight.

#### b. Brush Removal (Units Other than H. B. Co.) (fig. 77).

(1) **REMOVE SIDE PLATE.** Take out screws and lock washers holding ventilated side plate to exciter, and remove plate.

(2) **INSTALL BRUSH.** Lift lever arm, set brush in place in holder, and drop lever on brush.

(3) **TURN BRUSH HOLDER RING AND REMOVE BRUSH.** Loosen screw on brush holder ring, and turn ring until screw holding pigtail

**GENERATING SYSTEM**

connection is accessible. Remove screw, hold back spring lever arm, and take out brush.

**c. Brush Installation (Units Other than H. B. Co.).**

(1) **CONNECT BRUSH LEAD.** Attach pigtail to screw above brush holder bolt.

(2) **INSTALL BRUSH.** Lift lever arm, set brush in place in holder, and drop lever on brush.

(3) **TURN RING AND ATTACH SIDE PLATE.** Turn brush holder ring until line on ring coincides with casting rib. Attach plate with screws and lock washers.

**d. Brush Removal (H. B. Co. Unit).**

(1) **REMOVE EXCITER BEARING BRACKET COVER.** Remove machine screws, nuts, and lock washers holding louvered, sheet metal cover on exciter bearing bracket.

(2) **DISCONNECT PIGTAIL CONNECTION.** Loosen connection screw on bracket holding brush to commutator, and slide out pigtail connection lug.

(3) **REMOVE BRUSH.** Lift brush holder arm, and remove brush.

**e. Brush Installation (H. B. Co. Unit).**

(1) **INSTALL PIGTAIL CONNECTION.** Slide brush pigtail connection lug under connection screw on brush holder bracket. Tighten screw.

(2) **INSTALL BRUSH.** Lift brush holder arm, slide in brush, and drop arm to hold brush securely in place.

(3) **INSTALL COVER.** Place cover in position, securing with screws, lock washers, and nuts.

**f. Brush Springs.** Brush springs are designed to give a normal pressure of 12 to 14 ounces per brush. To check brush spring pressure, hook spring scale under spring at point where it bears on brush, and pull in direction of brush travel in brush holder, until finger is just lifted off brush.

**g. Brush Spring Removal (Units Other than H. B. Co.).**

(1) **REMOVE SIDE PLATE.** Take out screws and lock washers holding ventilating side plate to exciter.

(2) **TURN BRUSH HOLDER RING.** Loosen screw holding brush holder ring in position, and turn until brush holder bolt is accessible.

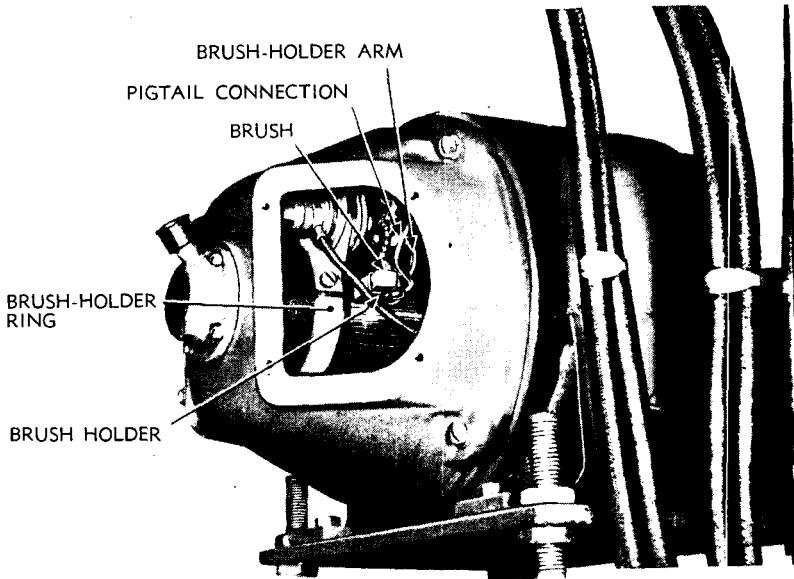
(3) **REMOVE BRUSH HOLDER BOLT FROM RING.** Loosen the three nuts on the brush holder bolt, and remove bolt and brush holder assembly from yoke of brush holder ring.

(4) **REMOVE SPRING.** Take out the round-head brass screw holding together the spring, the tension lever arm, a brass sleeve, and the brush holder arm.

**h. Brush Spring Installation (Units Other than H. B. Co.).**

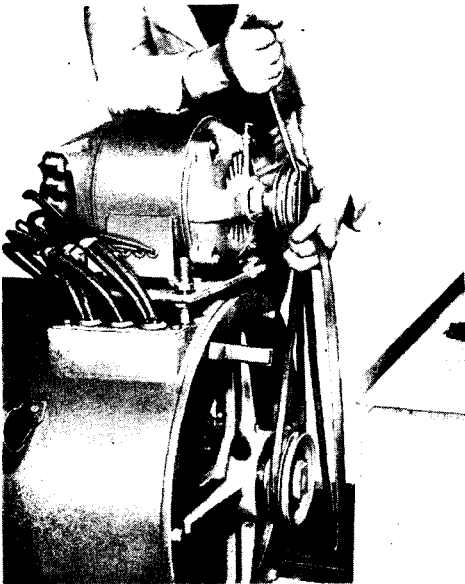
(1) **INSTALL SPRING HOLDING ASSEMBLY ON BRUSH HOLDER BOLT.** Slip round-head brass screw through hole in ratchet, and as-

**GENERATING UNIT M7**



RA PD 56990

**Figure 77—View of Exciter Brush Holder Ring, Brush and Spring**



RA PD 56991

**Figure 78—Removing Exciter Belts**

## GENERATING SYSTEM

semble tension lever arm, sleeve, spring, and brush holder arm on the bolt, screwing bolt tightly into brush holder arm.

(2) **INSTALL BRUSH HOLDER BOLT ON RING.** Bring bolt down into brush holder ring yoke with two fiber insulators on each side. Tighten the nuts until the bolt is held firmly to the yoke.

**i. Brush Spring Removal (H. B. Co. Unit) (fig. 76).**

(1) **REMOVE EXCITER BEARING BRACKET COVER** (subpar. d (1), above).

(2) **REMOVE SPRING HOLDER ASSEMBLY.** Hold nut, and remove bolt, washer, tension arm sleeve, spring adjusting washer, and spring.

**j. Brush Spring Installation (H. B. Co. Unit).**

(1) **INSTALL SPRING.** Assemble bolt and washer through tension arm sleeve. Set spring adjusting washer over spring. Carry bolt through brush holding flange, hold nut, and tighten bolt.

(2) **INSTALL COVER** (subpar. e (3), above).

**k. Commutator.** The commutator should be given a periodic inspection to make sure that all bars have an even and glossy appearance, and show a good polish without any blackening or roughening of the segments. If the commutator is rough or black, it should be lightly polished with PAPER, flint, class B, grade No. 2/0. Never use oil or abrasives other than PAPER, flint, class B, grade No. 2/0 on commutators.

**l. Belt Removal.** Remove belts connecting exciter and alternator as shown in figure 78.

**m. Belt Installation.** Use holding nuts on exciter plate posts to adjust exciter pulley to the proper position for installing belt from alternator pulley to exciter pulley (fig. 78).

### 89. 200-AMPERE POWER RECEPTACLE (fig. 79).

**a. Description.** The 200-ampere, 3-pole power receptacle is the larger of the two power receptacles located on the left side of the unit. It is of gooseneck-type, and is provided with a chained cap for protection when not in use.

**b. Maintenance.** Periodically, tighten receptacle mounting screws. When not in use, keep receptacles covered with cover furnished.

### 90. 30-AMPERE POWER RECEPTACLE (fig. 79).

**a. Description.** The 30-ampere, 3-pole power receptacle is the smaller of the two power receptacles located on the left side of the unit. It is of gooseneck-type, and is provided with a chained cap for protection when not in use.

**b. Maintenance.** (par. 89 b).

GENERATING UNIT M7

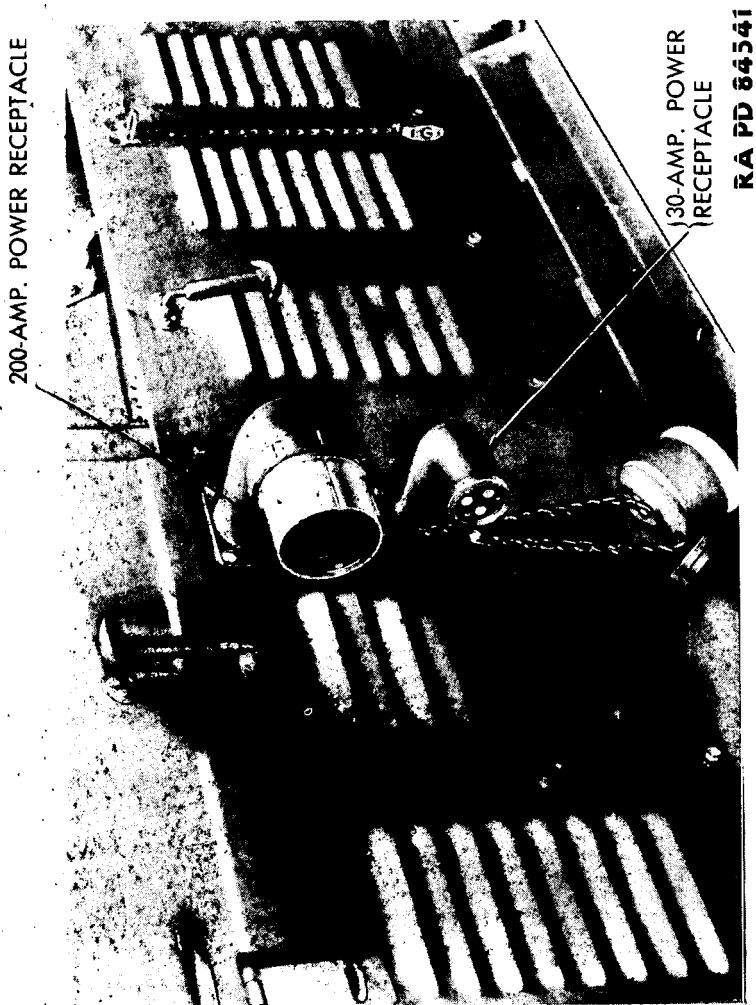


Figure 79 — Power Receptacles

## Section XVI

## INSTRUMENT PANEL AND INSTRUMENTS

	Paragraph
Instrument panel .....	91
Battery-charging ammeter .....	92
Oil pressure gage .....	93
Temperature gage .....	94
Fuel gage (U. S. M. Co. units only) .....	95
Tachometer .....	96
Voltmeter .....	97
Ammeter .....	98
Meter switch .....	99
Starter switch .....	100
Load switch .....	101
Field rheostat .....	102
Ignition switch .....	103
125-volt light receptacle .....	104
125-volt light switch .....	105
Lamp-dimming rheostat .....	106
6-volt light receptacle .....	107
6-volt light switch .....	108
6-volt extension cord receptacle .....	109
Throttle control .....	110
Choke control .....	111
T-slot receptacle .....	112
Terminal block .....	113
Fuse block .....	114

### 91. INSTRUMENT PANEL (figs. 8 and 80).

a. **Construction.** The instrument panel is of sheet-steel, and is located behind the rear left-hand door, above the alternator. It is held in place by four U-type steel clips bolted to brackets welded to housing uprights.

b. **Functioning.** The instrument panel carries all the controls and gages necessary to the starting, stopping, and general operation and control of the unit, with the exception of the fuel gage, which is mounted on the instrument panel only in the case of U.S.M. units (fig. 80). Other manufacturers make use of a mechanical gage set into the fuel tank (fig. 39). For convenience, the fire extinguisher is mounted at the right of the panel (fig. 14). The wiring diagrams (figs. 83 and 83A) show how the instruments are connected to the electrical circuit.



GENERATING UNIT M7

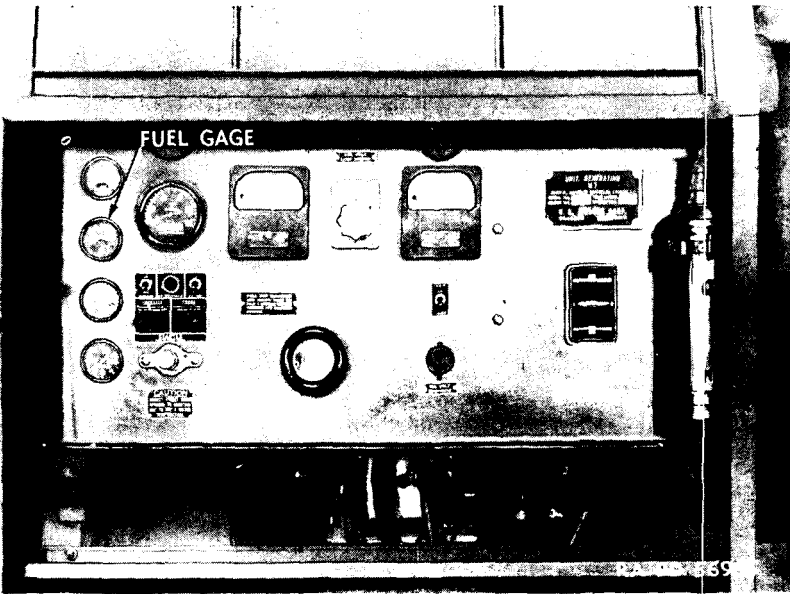
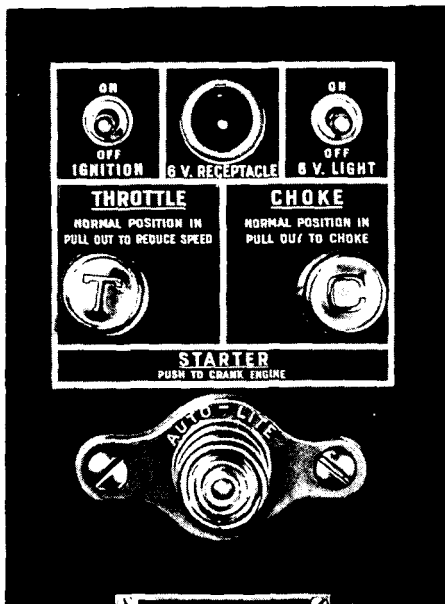


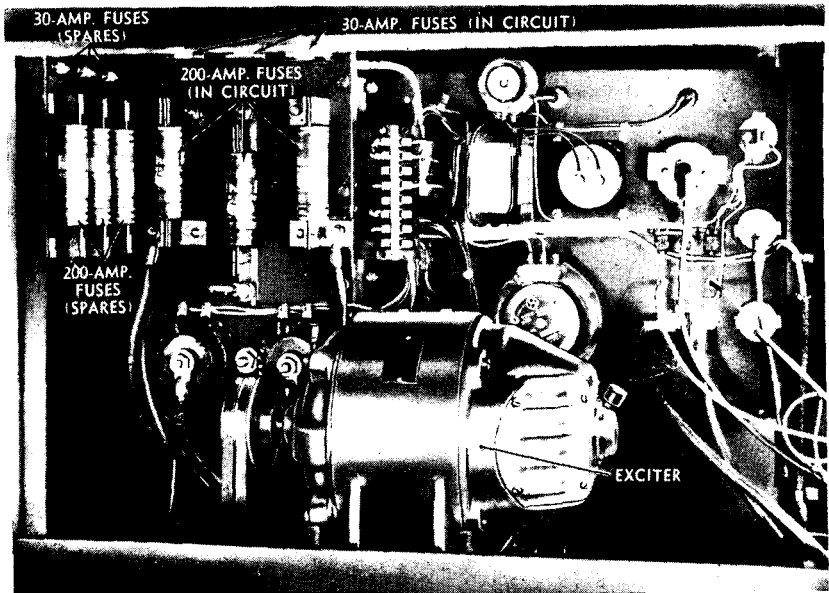
Figure 80—Instrument Panel U. S. M. Co.



RA PD 56996

Figure 81—Instrument Panel—Starter and Control Group

## INSTRUMENT PANEL AND INSTRUMENTS



RA PD 84538

*Figure 82—Instrument Panel—Rear View*

### 92. BATTERY-CHARGING AMMETER.

a. **Description.** The battery-charging ammeter, in the upper left-hand corner of the instrument panel, indicates the charge and discharge currents of the 6-volt battery.

#### b. Removal.

(1) **REMOVE AMMETER.** Remove nuts and star washers holding bracket against the rear of the panel, and remove bracket clips. Take off stop nuts attaching leads, and remove leads. Remove ammeter.

#### c. Installation.

(1) **INSTALL AMMETER.** Insert ammeter through the face of the instrument panel, and attach bracket clips over studs with nuts and star washers. Attach two wires marked "CG" to right connection, and wire marked "B" to left connection, with elastic stop nuts.

### 93. OIL PRESSURE GAGE.

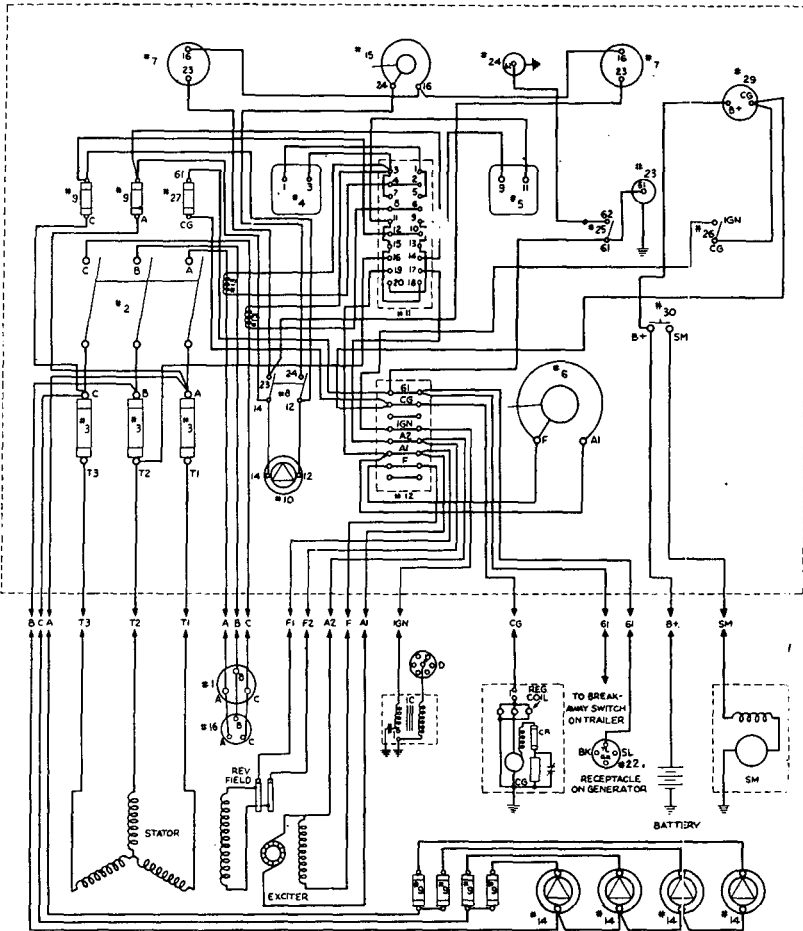
a. **Description.** The oil pressure gage is at the extreme left on the instrument panel, below the battery-charging ammeter. It is of the automotive type, and indicates pounds pressure per square inch. With the engine running at 1,200 rpm, the gage should indicate 25-pound pressure, if the engine is fully warmed up.

#### b. Removal.

(1) **REMOVE LINE.** Take nut from inverted flare tube fitting at back of gage (fig. 84), and remove line.

(2) **REMOVE GAGE.** Take nuts and star washers from bracket. Remove bracket and gage.

GENERATING UNIT M7



RA PD 57003

Figure 83—Wiring Diagram—(Key on Figure 83A)

c. Installation.

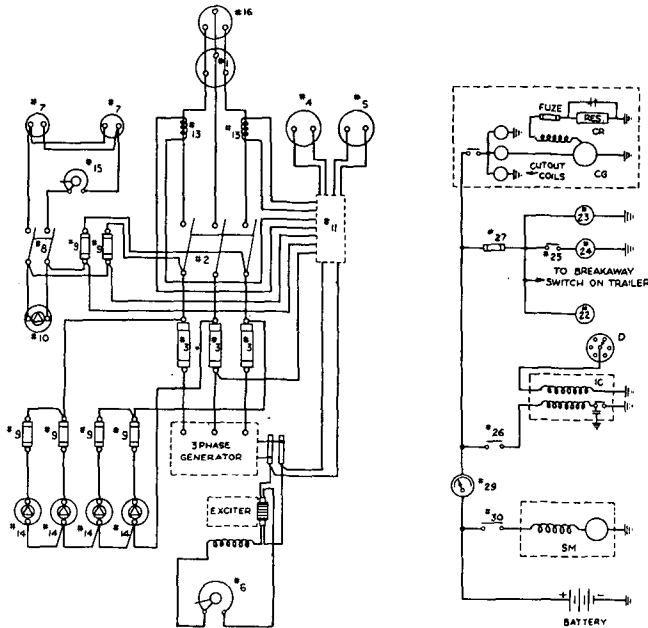
(1) **ATTACH OIL LINE.** Insert gage through face of instrument panel. Connect oil line from base of oil filter to inverted flare tube fitting.

(2) **INSTALL GAGE.** Secure gage to panel with bracket attached to studs by nuts and star washers.

94. TEMPERATURE GAGE.

a. **Description.** The temperature gage is located in the lower left-hand corner of the instrument panel. It indicates the temperature of the water in the engine. This should be maintained at between 160 degrees and 180 degrees F, while operating generating unit.

**INSTRUMENT PANEL AND INSTRUMENTS**



**125-VOLT AC CIRCUIT**

- 1 — LOAD RECEPTACLE
- 2 — LOAD SWITCH
- 3 — FUSE — 200 AMPS.
- 4 — AMMETER
- 5 — VOLTMETER
- 6 — RHEOSTAT
- 7 — LIGHTS
- 8 — SWITCH, 125-V. LIGHTS
- 9 — FUSES
- 10 — RECEPTACLE, EXTENSION CORD
- 11 — METER SWITCH
- 12 — TERMINAL BLOCK
- 13 — CURRENT TRANSFORMERS
- 14 — RECEPTACLE, POWER TOOLS
- 15 — RHEOSTAT, LIGHT DIMMING  
200-OHM, 1 TAPER, 1 AMP.
- 16 — LOAD RECEPTACLE, 30 AMPS.,  
C80109

**6 VOLT BATT. CIRCUIT**

- 22 — RECEPT. FOR BRAKES AND LIGHTS
- 23 — RECEPT. FOR EXTENSION CORD
- 24 — LIGHT
- 25 — LIGHT SWITCH
- 26 — IGNITION SWITCH
- 27 — FUSE
- 29 — AMMETER
- 30 — STARTER SWITCH
- CG — CHARGING GENERATOR
- CR — CHARGING VOLTAGE  
REGULATOR
- IC — IGNITION COIL
- D — DISTRIBUTOR
- SM — STARTER MOTOR

**SMALL WIRE COLOR CODE**

- |                |                    |
|----------------|--------------------|
| LINE A — RED   | EXCITER — A1 BLACK |
| LINE B — GREEN | + A2 WHITE         |
| LINE C — BLUE  | 6 VOLTS YELLOW     |

**Figure 83a—Wiring Diagram**

RA PD 57003A

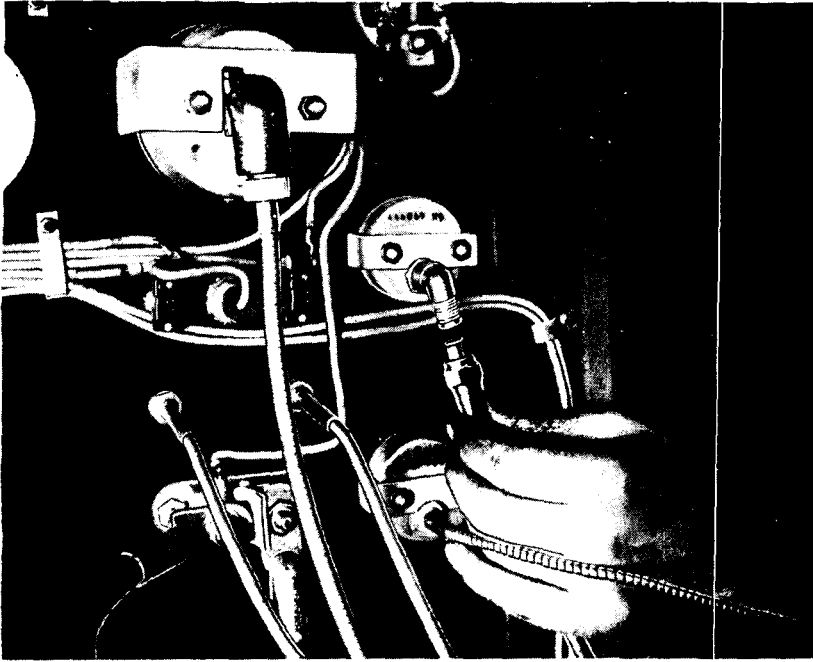
**b. Removal.**

- (1) **REMOVE LINE FROM ENGINE.** Unscrew temperature indicator bulb from engine head (fig. 85).
- (2) **REMOVE GAGE AND LINE.** Take off nuts and star washer holding bracket to panel, and remove gage.

**c. Installation.**

- (1) **ATTACH TEMPERATURE LINE.** Insert gage in instrument panel, and install bulb at end of gage line in tapped hole in engine head.

GENERATING UNIT M7



RA PD 56891

**Figure 84—Disconnecting Oil Pressure Line**

(2) **INSTALL GAGE.** Secure gage to instrument panel by attaching bracket over studs with nuts and star washers.

**95. FUEL GAGE (U. S. M. CO. UNITS ONLY).**

**a. Description.** The fuel gage is the second in the line of gages at the extreme left on the instrument panel (fig. 80). The gage is electrically connected to a float-operated unit in the fuel tank.

**b. Removal (U. S. M. Co. Units Only).**

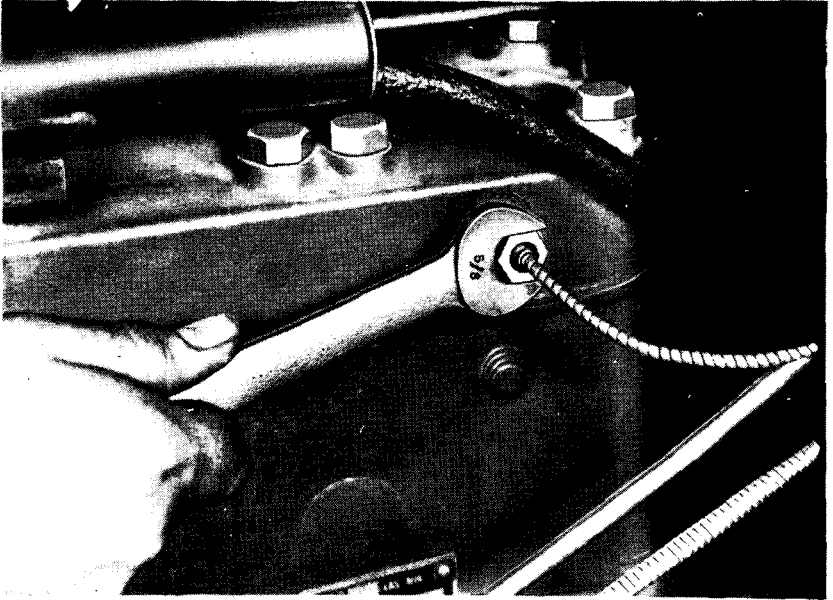
(1) **REMOVE GAGE.** Remove nuts, fiber washers, leads, and bracket from gage at rear of instrument panel. Remove gage.

**c. Installation (U. S. M. Co. Units Only).** Insert gage through front of instrument panel. Bring bracket over gage studs at rear. Secure the bracket holding the gage to the panel with washers and nuts. Attach two leads marked "IGN" to left-hand connection, attach lead marked "TA" to right-hand connection, and secure each with a fiber washer and a nut.

**96. TACHOMETER (fig. 86).**

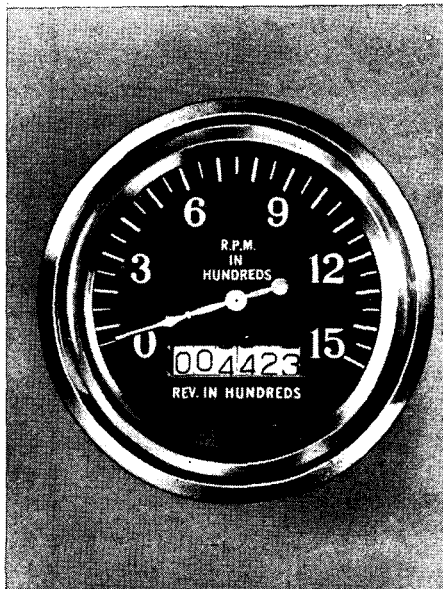
**a. Description.** The tachometer, below the left-hand light on the instrument panel, shows the revolutions per minute of the engine in hundreds. Also on the tachometer is an odometer which records

**INSTRUMENT PANEL AND INSTRUMENTS**



RA PD 56892

**Figure 85—Installing Temperature Indicator Bulb into Engine Cylinder Head**



RA PD 56998

**Figure 86—Tachometer Dial**

**GENERATING UNIT M7**

the total number of revolutions of the engine, also in hundreds of revolutions.

**b. Removal.**

(1) **REMOVE LINE.** Disconnect line by removing swivel nut from connector elbow.

(2) **REMOVE TACHOMETER.** Take out bracket holding tachometer to panel by removing elastic stop nuts. Remove tachometer.

**c. Installation.**

(1) **ATTACH TACHOMETER TO PANEL.** Insert tachometer in panel, and secure by fastening bracket to tachometer and against panel with elastic stop nuts.

(2) **ATTACH TACHOMETER LINE.** Bring tachometer line to connection elbow at bottom of tachometer, and secure with swivel nut.

**97. VOLTMETER.**

**a. Description.** The voltmeter, just right of the tachometer on the instrument panel, indicates the voltage of the exciter current and the voltage of the current generated by the unit, which is normally 125 volts. At this point on the dial is a red line. For procedure in obtaining these readings, see paragraph 8 c, and figures 11 and 12.

**b. Removal.**

(1) **REMOVE VOLTMETER FROM PANEL.** Hold elastic stop nuts on back of panel, and unscrew the four corner bolts on face of voltmeter. Removing these bolts will release two 4-wire straps.

(2) **REMOVE LEADS.** Take elastic stop nuts from the connections on the back of the voltmeter. Remove leads and voltmeter.

**c. Installation.**

(1) **INSTALL VOLTMETER ON PANEL.** Hold voltmeter on face of instrument panel with mounting holes in meter over mounting holes in panel. Insert bolts through holes. On top bolts at rear of panel, place the wire clips that hold the two wires from the 125-volt lamp socket. On bottom bolts, place clips to engage the six wires that pass underneath the meter. Hold bolts and elastic stop nuts over the clips on the bolts.

(2) **CONNECT LEADS.** To the right-hand connection post, attach lead marked "11." To the left-hand post attach lead "9." Screw on elastic stop nuts.

**98. AMMETER.**

**a. Description.** The ammeter is centrally located on the instrument panel opposite the voltmeter. The ammeter indicates the amperage of the current delivered in the phases of the circuit. See paragraph 8 c, and figure 12.

**b. Removal.**

(1) **REMOVE AMMETER FROM PANEL.** Hold elastic stop nuts on

## INSTRUMENT PANEL AND INSTRUMENTS

back of panel, and unscrew the four corner bolts on the face of the ammeter. Removing these bolts will release a 3-wire strap held by each of the bolts on the right-hand side of the meter.

(2) **REMOVE LEADS.** Take elastic stop nuts from the connections on the back of the ammeter. Remove leads and ammeter.

### c. Installation.

(1) **INSTALL AMMETER ON PANEL.** Hold ammeter on face of panel with mounting holes in meter over mounting holes in panel. Insert bolts through holes. On each right-hand bolt at rear of panel, place a 3-wire clip to engage two wires marked "23" and one wire marked "24." Hold bolts, and screw elastic stop nuts on bolt ends.

(2) **CONNECT LEADS.** To the right-hand connection post, attach lead marked "3." To the left-hand post attach lead marked "1."

## 99. METER SWITCH.

a. **Description.** The meter switch, centrally located on the instrument panel, connects the voltmeter and ammeter simultaneously to each phase of the circuit as the switch knob is turned to "A," "B," and "C" positions. With the knob turned to a fourth position, marked "EXC," the voltmeter shows the exciter voltage and the ammeter is disconnected. See paragraph 8 c, and figures 11 and 12.

## 100. STARTER SWITCH (fig. 81).

a. **Description.** The engine starter, or cranking switch, is mounted on the left side of the instrument panel, directly below the throttle and choke knobs. It is of the conventional automotive type.

### b. Removal.

(1) **REMOVE LEADS.** Take off elastic stop nuts and washers from connections on the back of the starter switch, and remove leads.

(2) **REMOVE SWITCH.** Hold screws through face plate. Remove nuts and lock washers at rear of board. Remove face plate from front of panel and switch block from rear.

### c. Installation.

(1) **MOUNT SWITCH.** Place switch, with face plate removed, in position at the rear of the instrument panel, the button projecting through and the mounting holes lined up with holes through the panel. Pass face plate over button and install switch by connecting face plate and switch through panel with screws, lock washers, and nuts. Hold screws and attach nuts.

(2) **CONNECT LEADS.** To the right-hand connection on the starter switch, attach lead marked "SM" and secure with elastic stop nut. To the left-hand connection, attach lead marked "B+." Secure with elastic stop nut.



**GENERATING UNIT M7**

**101. LOAD SWITCH.**

a. **Description.** The load switch, which is the switch that controls the delivery of current to the power receptacles and from them to the load, is a lever type. It is located on the right side of the instrument panel, below the unit name plate. When handle is in top position, the current is "ON." Bottom position is "OFF." Bolted to the back of the load switch is a panel holding the three 200-ampere fuses, three 30-ampere fuses, and the two current transformers.

**102. FIELD RHEOSTAT.**

a. **Description.** The field rheostat knob is located toward the bottom of the instrument panel, just left of center. It controls the output voltage of the unit. To increase the voltage of the current delivered, the knob is turned counterclockwise. The minimum voltage position, which is also the starting and stopping position, is with the knob turned clockwise as far as possible.

**b. Removal.**

(1) **REMOVE LEADS.** Disconnect leads from binding posts at rear of rheostat by removing nuts and lock washers.

(2) **REMOVE KNOB.** Take out vertical screw holding rheostat knob to shaft, and remove knob.

(3) **REMOVE RHEOSTAT.** Take out two screws on the face of the instrument panel holding rheostat to panel.

**c. Installation.**

(1) **ATTACH RHEOSTAT.** Attach rheostat to instrument panel with screws through panel into rheostat tapped holes.

(2) **INSTALL KNOB.** Slip knob over rheostat shaft, and secure to shaft with vertical screw.

(3) **ATTACH LEADS.** Attach lead marked "A-1" to the left-hand binding post of the rheostat, and secure with nut and lock washer. Attach lead marked "F" to center post of rheostat, and install a wire jumper from center post to right-hand post. Secure with nuts and lock washers.

**103. IGNITION SWITCH (fig. 81).**

a. **Description.** The toggle-type, single-pole, single-throw ignition switch is at the upper left in the control group on the left side of the instrument panel. This switch controls the starting and ignition system (section XIV).

**b. Removal.**

(1) **REMOVE LEADS.** Take out screws holding down leads at the back of the switch, and remove leads.

(2) **REMOVE SWITCH.** Remove ring nut from switch on front of instrument panel. Remove nut from switch on rear of panel. Remove switch.

## INSTRUMENT PANEL AND INSTRUMENTS

### c. Installation.

(1) **INSTALL SWITCH.** Set switch in position on rear of panel with neck projecting through hole. Screw on ring nut so it is just flush with edge of neck. In back of the panel, screw nut tightly against panel.

(2) **CONNECT LEADS.** Remove screw connectors from switch. To one pole of switch, connect lead marked "IGN." To the other pole, connect lead "CG." Replace the screws.

## 104. 125-VOLT LIGHT RECEPTACLE.

a. **Description.** At the top of the instrument panel are two 125-volt rubber-mounted light receptacles. They are controlled by the 125-volt light switch in the center of the panel, and the amount of the illumination given is regulated by the lamp-dimming rheostat set between them.

### b. Removal.

(1) **REMOVE LEADS.** Trace lead "16" to lamp-dimming rheostat; remove nut and lock washer, and remove lead. Trace lead "23" to 125-volt light switch; remove screw and lead.

(2) **REMOVE RECEPTACLE.** Hold screws, remove nuts and lock washers at back of instrument panel, and remove receptacle.

### c. Installation.

(1) **INSTALL RECEPTACLE.** Bring receptacle to mounting holes in the front of the panel. Install with bolts through receptacle and panel, lock washers, and nuts at rear.

(2) **INSTALL LEADS.** Connect receptacle lead "16" to the left connection of the lamp-dimming rheostat. Secure with lock washer and nut. Connect receptacle lead "23" to the top left connection of the 125-volt light switch. Secure leads with screws.

## 105. 125-VOLT LIGHT SWITCH.

a. **Description.** The toggle-type, double-pole, single-throw, 125-volt light switch is centrally located on the instrument panel below the ammeter. This switch turns on the 125-volt lamps at the top of the panel.

### b. Removal (par. 103 b).

### c. Installation.

(1) **INSTALL SWITCH.** Remove ring nut from switch. Set switch in position on panel with neck projecting through hole. Screw on ring nut so that it is just flush with edge of neck. In back of the panel, screw nut tightly against panel. Secure ring nut against front of panel.

(2) **CONNECT LEADS.** Remove screw connectors. To the top left connection, bring two leads marked "23." To the top right connection, bring lead marked "24." The lower left connection takes two leads marked "14." The lower right connection takes two leads marked "12." Secure leads with screws.

**GENERATING UNIT M7**

**106. LAMP-DIMMING RHEOSTAT.**

a. **General.** Centrally located at the top of the instrument panel is the lamp-dimming rheostat, used to dim the 125-volt lamps.

b. **Removal.**

(1) **REMOVE LEADS.** Take off nuts and lock washers from connections on rear of rheostat. Remove leads.

(2) **REMOVE KNOB.** Take out screw through rheostat knob, and slide knob off.

(3) **REMOVE RHEOSTAT.** Unscrew nut holding rheostat shaft sleeve against the face of the panel, and slide rheostat out at the back of the panel.

c. **Installation.**

(1) **SECURE IN PLACE.** Install rheostat at back of panel with shaft projecting through panel. Secure in place with nut on shaft sleeve set tight against face of panel.

(2) **INSTALL KNOB.** Twist knob on shaft, and secure by tightening screw through knob against flattened part of shaft.

(3) **CONNECT LEADS.** Install two leads marked "16" to the left connection on the rheostat. Install lead marked "24" on the center post. Secure with lock washers and nuts.

**107. 6-VOLT LIGHT RECEPTACLE.**

a. **Description.** A 6-volt light receptacle is located at the top of the instrument for use in illuminating the panel at times when the unit is not running and the 125-volt circuit cannot be used. This light is controlled by the toggle switch at the upper right in the control group above the starter button.

b. **Removal.**

(1) **REMOVE LEAD.** Loosen horizontal screw through the body of the receptacle, and remove lead from center of back.

(2) **REMOVE RECEPTACLE.** Unscrew nut from the tapped receptacle ring; remove lock washer and receptacle.

c. **Installation.**

(1) **SECURE RECEPTACLE IN PLACE.** Insert receptacle through panel until rim holds it in place. Install lock washer and nut on back of receptacle.

(2) **INSTALL LEAD.** Insert lead wire "62" into connection hole at back of receptacle. Secure wire in place by tightening horizontal screw through body of receptacle.

**108. 6-VOLT LIGHT SWITCH.**

a. **Description.** The toggle-type, single-pole, single-throw, 6-volt light switch is at the upper right in the control group on the left side of the instrument panel. This switch controls the 6-volt light which furnishes illumination when the unit is not running.

## INSTRUMENT PANEL AND INSTRUMENTS

b. **Removal.** Follow procedure outlined in paragraph 103 b.

c. **Installation.**

(1) **INSTALL SWITCH.** Remove ring nut from switch. Set switch in position on panel with neck projecting through hole. Screw on ring nut so that it is just flush with edge of neck. In back of the panel, screw nut tightly against panel. Secure ring nut against front of panel.

(2) **CONNECT LEADS.** Remove the screw connectors from the switch. To one pole connect lead marked "62." To the other pole connect two leads marked "61." Replace the screws.

### 109. 6-VOLT EXTENSION CORD RECEPTACLE.

a. **Description.** A receptacle to take the 6-volt trouble light, which is carried in the tool box, is provided at top center in the control group above the starter button (fig. 81).

b. **Removal.** Follow procedure outlined in paragraph 107.

c. **Installation.**

(1) **SECURE RECEPTACLE IN PLACE.** Insert receptacle through panel until rim holds it in place. Install lock washer and nut on back of receptacle.

(2) **INSTALL LEAD.** Insert lead wire "61" into connection hole at back of receptacle. Secure wire in place by tightening horizontal screw through body of receptacle.

### 110. THROTTLE CONTROL.

a. **Description.** The throttle knob is at the lower left in the control group on the left side of the instrument panel (fig. 81). This knob has a wire connection with a valve in the throttle box below the carburetor. Pulling out the knob reduces the amount of fuel mixture supplied the engine, and reduces engine speed.

b. **Removal.**

(1) **REMOVE THROTTLE CONTROL WIRE.** Loosen clamping screws holding throttle wire and casing to carburetor throttle lever arm (fig. 87), and remove wire. Loosen bolt through support bracket on top of engine, and remove wire from bracket.

(2) **REMOVE CONTROL.** Unscrew nut from throttle knob casing on back of instrument panel, and remove nut and lock washer. Remove knob, casing, and wire from the front of the instrument panel.

c. **Installation.**

(1) **INSTALL CONTROL.** Insert throttle wire and casing through instrument panel hole until rim of knob casing holds against front of panel. Carry lock washer and nut over wire, and tighten nut on threaded section of knob casing until the assembly is held securely in place.

(2) **CONNECT TO CARBURETOR.** Carry wire casing to clamp on top of engine, loosen clamp screw, secure wire, and tighten screw of engine

## GENERATING UNIT M7

with wire in place. Bring wire to throttle lever arm on carburetor, hold lever arm forward, and connect wire to binding post on arm.

### 111. CHOKE CONTROL.

a. **Description.** The choke knob is at the lower right in the control group on the left side of the instrument panel (fig. 81). This knob has a wire connection to a valve in the carburetor that regulates the carburetor air supply. Pulling out the knob cuts down on the amount of air to the carburetor.

#### b. Removal.

(1) **REMOVE CHOKE CONTROL WIRE.** Loosen clamping screws holding choke wire and casing to carburetor valve arm, and remove wire. Loosen bolt through support bracket on top of engine, and remove wire from bracket.

(2) **REMOVE CONTROL.** Unscrew nut from choke knob casing on back of instrument panel, and remove nut and lock washer. Remove knob, casing, and wire from the front of the instrument panel.

#### c. Installation.

(1) **INSTALL CONTROL.** Insert choke wire and casing through instrument panel hole until rim of knob casing holds against front of panel. Carry lock washer and nut over wire at back of instrument panel, and tighten nut on threaded section of knob casing in front of panel until the assembly is held securely in place.

(2) **CONNECT TO CARBURETOR.** Carry wire casing to clamp on top of engine, loosen clamp screw, secure wire, and tighten screw with wire in place. Bring wire to carburetor, hold lever arm forward, and connect wire to binding post on choke lever arm.

### 112. T-SLOT RECEPTACLE.

a. **Description.** One T-slot receptacle, of the regular base receptacle type, is provided on the instrument panel, and four on the apron below. The one on the panel is intended for use with 125-volt trouble light carried in the tool box. The receptacles on the apron are for electric tools.

#### b. Removal.

(1) **REMOVE LEADS.** Unscrew connector screws at back of receptacle, and take off leads.

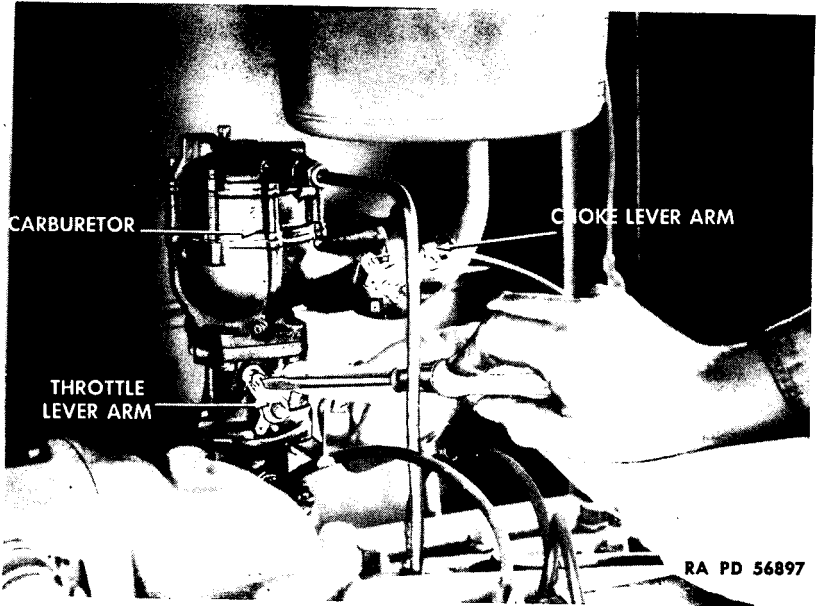
(2) **REMOVE RECEPTACLE.** Take out the two screws holding the receptacle to the panel, and remove receptacle.

#### c. Installation.

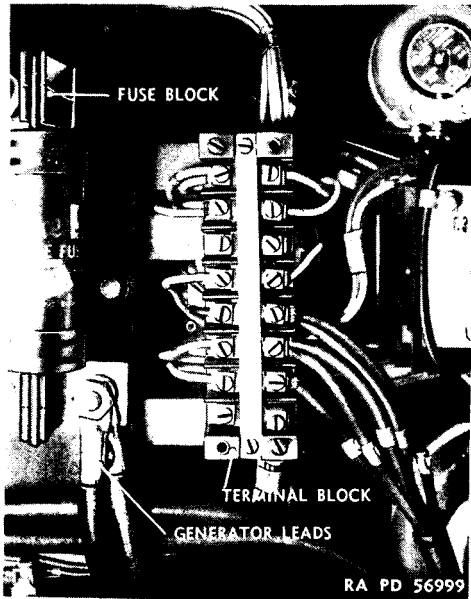
##### (1) PANEL RECEPTACLE.

(a) *Install Receptacle.* Insert receptacle through hole from rear of instrument panel, alining tapped mounting holes in receptacle's ears with mounting holes in panel. Secure receptacle to panel with screws through panel and receptacle.

**INSTRUMENT PANEL AND INSTRUMENTS**

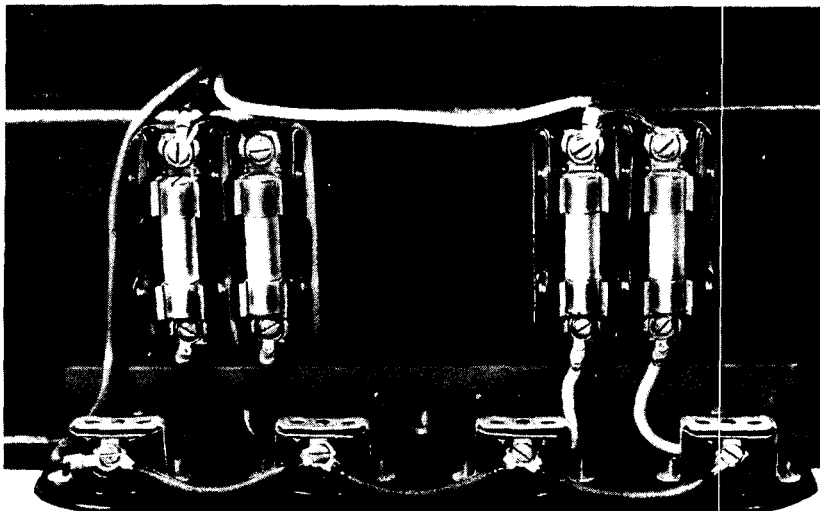


**Figure 87—Throttle Wire Installation**



**Figure 88—Terminal Block**

GENERATING UNIT M7



RA PD 57000

**Figure 89—30-Ampere Fuses and T-Slot Receptacles**

(b) *Install Leads.* Attach lead marked "14" to one receptacle connection, lead marked "12" to the other. Secure with screws.

(2) APRON RECEPTACLES.

(a) Insert receptacle through hole from rear of instrument panel, aligning tapped mounting hole in receptacle with mounting holes in panel. Secure receptacle to panel with screws through panel and receptacle.

(b) *Install Leads.* Attach two leads marked "1A" to one connection, one lead marked "9" to the other connection. Secure with screws. The end receptacle of the series will take only one "14" lead.

**113. TERMINAL BLOCK (fig. 88).**

a. **Description.** An 8-position terminal block in back of the instrument panel handles connections for both 6-volt and 125-volt circuits. A center label strip identifies the connections. The third and the eighth positions are unused. The block is mounted on arms welded to the load switch bracket.

b. **Maintenance.** Periodically, make a check on the cable connections at the terminal block. Check for clean and tight connections. Connections showing signs of corrosion must be removed and thoroughly scraped clean.

**114. FUSE BLOCK (fig. 89).**

a. **Description.** Two double-fuse blocks are located on the under side of the instrument panel bottom ledge. These fuse blocks hold four 30-ampere fuses connected with the four T-slot receptacles on the instrument panel apron.

**PAINTING**

b. **Maintenance.** Periodically, tighten all cable connections on fuse clips. Remove and clean all corroded cable connections.

**Section XVII**

**PAINTING**

	Paragraph
General .....	115
Preparing for painting .....	116
Painting metal surfaces .....	117
Paint as a camouflage .....	118
Removing paint .....	119
Painting lubricating devices .....	120

**115. GENERAL.**

a. Ordnance materiel is painted before it is issued to the using arms, and one maintenance coat per year will ordinarily be ample for protection. With but few exceptions, this materiel will be painted with **ENAMEL**, synthetic, olive-drab, lusterless. The enamel may be applied over old coats of long oil enamel and oil paint previously issued by the Ordnance Department, if the old coat is in satisfactory condition for repainting.

b. Paints and enamels are usually issued ready for use, and are applied by brush or spray. They may be brushed on satisfactorily when used unthinned in the original package consistency, or when thinned no more than 5 percent by volume with **THINNER**, for synthetic enamels. The enamel will spray satisfactorily when thinned with 15 percent by volume of **THINNER**, for synthetic enamels. (Linseed oil must not be used as a thinner, since it will impart a luster not desired in this enamel.) If sprayed, it dries hard enough for repainting within ½ hour, and dries hard in 16 hours.

c. Complete information on painting is contained in TM 9-850.

**116. PREPARING FOR PAINTING.**

a. If the base coat on the materiel is in poor condition, it is more desirable to strip the old paint from the surface with **REMOVER**, paint and varnish, than to use sanding and touch-up methods. After stripping, it will then be necessary to apply a primer coat.

b. **PRIMER**, synthetic, refinishing, should be used on wood as a base coat for synthetic enamel. It may be applied either by brushing or spraying. It will brush satisfactorily as received, or after the addition of not more than 5 percent by volume of **THINNER** paint,



## GENERATING UNIT M7

volatile mineral spirits. It will be dry enough to touch in 30 minutes, and hard in 5 to 7 hours. For spraying, it may be thinned with not more than 15 percent by volume of THINNER paint, volatile mineral spirits. Lacquers must not be applied to the PRIMER, synthetic, refinishing, within less than 48 hours.

c. PRIMER, synthetic, rust-inhibiting, for bare metal, should be used on metal as a base coat. Its use and application are similar to that outlined in subparagraph b, above.

d. The success of a job of painting depends partly on the selection of a suitable paint, but also largely upon the care used in preparing the surface prior to painting. All parts to be painted should be free from rust, dirt, grease, kerosene, oil, and alkali, and must be dry.

### 117. PAINTING METAL SURFACES.

a. If metal parts are in need of cleaning, they should be washed in a liquid solution consisting of  $\frac{1}{2}$  pound of SODA ASH in 8 quarts of warm water, then rinsed in clear water and wiped thoroughly dry. Wood parts in need of cleaning should be treated in the same manner, but the alkaline solution must not be left on for more than a few minutes, and the surfaces should be wiped dry as soon as they are washed clean. When equipment is in fair condition, and marred only in spots, the bad places should be touched up with ENAMEL, synthetic, olive-drab, lusterless, and permitted to dry. The whole surface will then be sandpapered with PAPER, flint, Class B, No. 1, and a finish coat of ENAMEL, synthetic, olive-drab, lusterless, applied, and allowed to dry thoroughly before the materiel is used. If the equipment is in bad condition, all parts should be thoroughly sanded with PAPER, flint, Class B, No. 2, or equivalent, given a coat of PRIMER, synthetic, refinishing, and permitted to dry for at least 16 hours. Then sandpaper with PAPER, flint, Class B, No. 2/0, wipe free from dust and dirt, and apply a final coat of ENAMEL, synthetic, olive-drab, lusterless. Allow to dry thoroughly before the materiel is used.

### 118. PAINT AS A CAMOUFLAGE.

a. Camouflage is now a major consideration in painting ordnance equipment, with rust prevention secondary. The camouflage plan at present employed utilizes three factors: color, gloss, and stenciling.

(1) COLOR. The equipment is painted with ENAMEL, synthetic, olive-drab, lusterless, which was chosen to blend in reasonably well with the average landscape.

(2) GLOSS. The new lusterless enamel makes equipment difficult to see from the air or from relatively great distances over land. A unit painted with ordinary glossy paint can be detected more easily and at greater distances.

## PAINTING

(3) **STENCILING.** White stencil numbers have been eliminated because they can be photographed from the air. **ENAMEL**, synthetic, stenciling, lusterless, blue-drab, is now used, which cannot be so photographed. It is illegible to the eye at distances exceeding 75 feet.

### b. Preserving Camouflage.

(1) Continued friction or rubbing must be avoided, as it will smooth the surface and produce a gloss. The unit should not be washed more than once a week. Care should be taken to see that the washing is done entirely with a sponge or a soft rag. The surface should never be rubbed or wiped, except while wet, or a gloss will develop.

(2) It is not desirable that equipment, painted with lusterless enamel, be kept as clean as equipment was kept when glossy paint was used. A small amount of dust increases the camouflage value. Grease spots should be removed with **SOLVENT**, dry-cleaning. Whatever portion of the spot cannot be so removed should be allowed to remain.

(3) Continued friction of wax-treated tarpaulins on the sides of a vehicle will also produce a gloss which should be removed with **SOLVENT**, dry-cleaning.

(4) Tests indicate that repainting with olive-drab enamel will be necessary once yearly, with blue-drab stenciling enamel twice yearly.

## 119. REMOVING PAINT.

a. After repeated paintings, the paint may become so thick as to crack and scale off in places, presenting an unsightly appearance. If such is the case, remove the old paint by use of a lime-and-lye solution (see TM 9-850 for details) or **REMOVER**, paint and varnish. It is important that every trace of lye or other paint remover be completely rinsed off, and that the equipment be perfectly dry before repainting is attempted. It is preferable that the use of lye solutions be limited to iron or steel parts. If used on wood, the lye solution must not be allowed to remain on the surface for more than a minute before being thoroughly rinsed off, and the surface wiped dry with rags. Crevices or cracks in wood should be filled with putty, and the wood sandpapered before refinishing.

## 120. PAINTING LUBRICATING DEVICES.

a. A circle about  $\frac{3}{4}$  inch in diameter will be painted with **ENAMEL**, red, water-resisting, around each joint of lubrication, such as oil cups, grease fittings, oil holes, and similar lubricating devices, in order that they may be readily located. Do not paint openings in fittings through which lubricant passes.

**GENERATING UNIT M7**

**Section XVIII**

**STORAGE AND SHIPMENT**

	Paragraph
Domestic shipment .....	121
Rail shipment .....	122
Limited storage .....	123

**121. DOMESTIC SHIPMENT.**

**a. General.** The Generating Unit M7, when mounted on a trailer chassis, will be shipped uncrated for domestic shipment by rail (par. 122).

**b. Preparation.**

(1) **LUBRICATION.** Lubricate unit in accordance with lubricating instructions, section IV.

(2) **FUEL.** Drain fuel from fuel tank.

(3) **BATTERY.**

(a) Disconnect battery lead terminals. Clean and tape the terminals, and secure away from the battery posts.

(b) Apply coating of **COMPOUND**, rust-preventive, light, to battery posts.

(c) Batteries shall be recharged before shipment if hydrometer readings fall below 1.275.

(4) **PAINTING.**

(a) All painted surfaces that have become checked, pitted, or rusted shall be thoroughly cleaned and rust spots removed.

(b) Apply coating of **PRIMER**, synthetic, rust-inhibiting to bare metal as a base for surfaces to be repainted.

(c) Apply coating of **ENAMEL**, synthetic, olive-drab, lusterless, and allow to dry thoroughly.

(5) **APPLICATION OF PRESERVATIVE.** Application of preservative should be accomplished immediately after cleaning.

(a) Unpainted metal surfaces should be treated with **COMPOUND**, rust-preventive, thin film, by spraying or brushing. This preservative does not require heating nor further solvent dilution before application.

(6) **INSPECTION.** Make a systematic inspection just before shipment or storage, and list all missing or broken items that are not replaced or repaired, and attach list to unit.

(7) **ENGINE PREPARATION.** Instructions for preparation of engines for shipment will be found in **IOSSC-(j)**, Introduction to Ordnance Storage and Shipment Chart, section (j), "Preparation of Unboxed Ordnance Materiel for Shipment."

## STORAGE AND SHIPMENT

### 122. RAIL SHIPMENT.

a. **Inspection of Railroad Cars.** Inspect floors of all railroad cars to be sure they are sound, and that all nails and other projections have been removed.

b. **Brake Wheel Clearance.** Each railroad car must be loaded with a resulting brake wheel clearance of at least 6 inches in front, on top, and at each side of the brake wheel.

c. **Clearance Limits.** The height and width of load must be within the clearance limits of the railroads over which it is to be moved. Army and railroad officials must check all clearances prior to each move.

d. **Placarding.** Each railroad car must be placarded "DO NOT HUMP."

e. **Brake.** Apply hand brake.

f. **Blocking Trailer and Unit on Railroad Car (fig. 90).**

(1) **TRAILER WHEELS.**

(a) **Blocks C.** Place one block C across the front of the trailer tires, and one at the rear tires (2 blocks C required). These blocks will be at least 8 inches longer than the over-all width of the tires.

(b) **Cleats B.** Place two cleats B to the front of block C at each wheel (8 cleats B required). Nail the lower cleat to the car floor with three 40-penny nails, and nail the top cleat to the cleat below with three 40-penny nails.

(c) **Cleats E.** Place one cleat E against the outside face of each wheel on the top of block C (2 cleats E required). Nail cleats E to each block C with four 40-penny nails.

(d) **Strapping Trailer Wheels D.** Secure unit at each wheel by strapping, consisting of four strands, two wrappings of No. 8 gage, black annealed wire. Pass wire through opposite openings in wheels, and attach at the nearest stake pockets of the car. Tighten wire sufficiently to remove slack.

**NOTE:** When box cars are used, strapping should be applied in similar fashion, and attached to car floor by use of blocking or anchor plates.

(e) Position trailer chassis support legs at the four corners of the unit.

(2) **DRAWBAR.**

(a) **Block F.** Place one block F under tongue of unit in center, and toenail to car floor, using four 40-penny nails (one block F required).

(b) **Cleats G.** Locate on floor against four sides of block F. Nail to floor, using four 20-penny nails in each cleat (four cleats G required).

(c) **Braces H.** Cut braces long enough to extend from floor to top of block F. Nail to block F, cleats G, and the car floor with three 20-penny nails in each end (four braces H required).

GENERATING UNIT M7

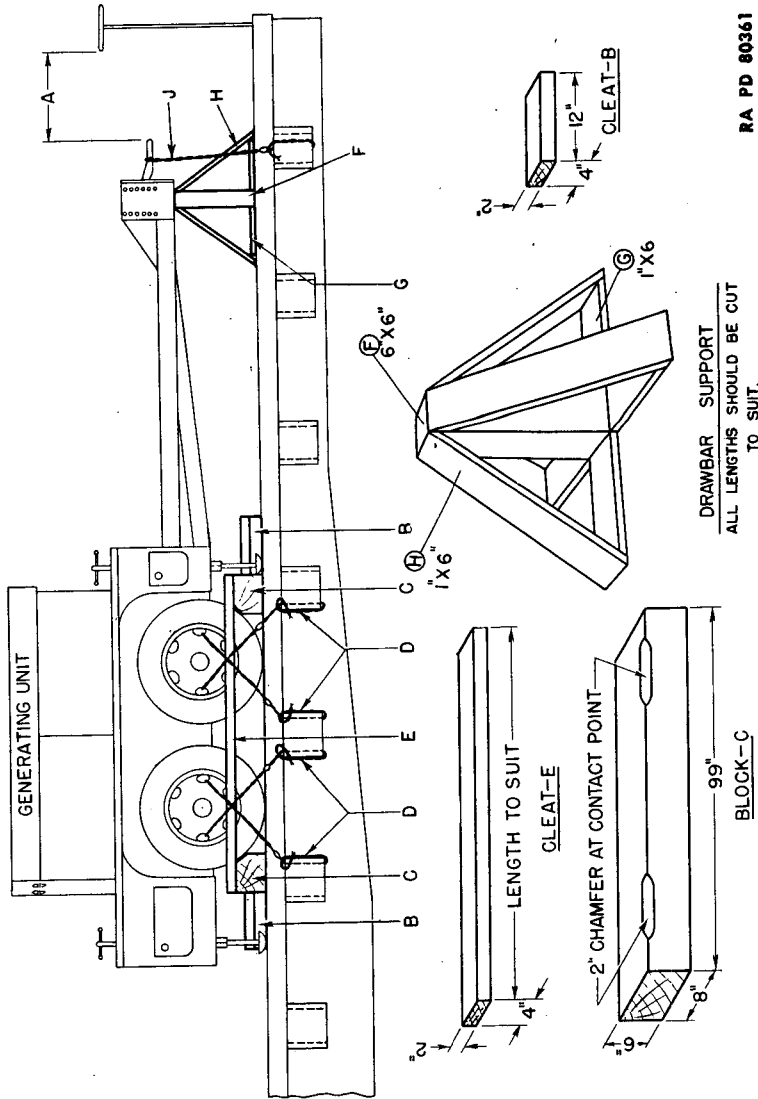


Figure 90—Method of Blocking Generator Trailer M7 on Railroad Car

### STORAGE AND SHIPMENT

(d) *Strapping Drawbar J.* Secure drawbar at stake pocket on each side of car by looping wire, 6 strands, 2 wrappings, No. 8 gage, black annealed around lunette. Twist each wire taut with rod or bolt.

#### 123. LIMITED STORAGE.

a. Trailer and unit will be prepared for limited storage as described in paragraph 121.

b. Periodical inspections shall be made while the materiel is stored, to note among other things, general condition, missing parts, and the need for repairs. If found to be corroding at any part, the entire procedure for preparation for storage herein listed shall be repeated.

GENERATING UNIT M7

Section XIX

REFERENCES

	Paragraph
Standard nomenclature lists .....	124
Explanatory publications .....	125

124. STANDARD NOMENCLATURE LISTS.

- a. Trailer, generator, M7 ..... SNL F-226
- b. Unit, generating, M7 ..... SNL F-283

Current Standard Nomenclature lists are as tabulated here. An up-to-date list of SNL's is maintained as the "Ordnance Publications for Supply Index" now published in..... OFSB 1-1

125. EXPLANATORY PUBLICATIONS.

- a. Automotive electricity ..... TM 10-580
- b. Automotive lubrication ..... TM 10-540
- c. Camouflage ..... FM 5-20
- d. Chassis, body and trailer units ..... TM 10-560
- e. Chemical decontamination materials and equipment ..... TM 3-220
- f. Cleaning, preserving, lubricating, and welding materials and similar items issued by the Ordnance Department ..... TM 9-850
- g. Cold weather lubrication and service of artillery equipment ..... OFSB 6-5
- h. Cold weather lubrication and service of combat and automotive equipment ..... OFSB 6-11
- i. Defense against chemical attack ..... FM 21-40
- j. Detailed lubrication instructions, ordnance materiel ..... OFSB 6-series
- k. Fuels and carburetion ..... TM 10-550
- l. Hand, measuring, and power tools ..... TM 10-590

**REFERENCES**

- m. List of publications for training . . . . . FM 21-6
- n. Maintenance and care of pneumatic tires and  
    rubber treads . . . . . TM 31-200
- o. Motor transport . . . . . FM 25-10
- p. Motor transport inspections . . . . . TM 10-545
- q. Motor vehicles . . . . . AR 850-15
- r. Ordnance storage and shipment chart—  
    Group F . . . . . OSSC F
- s. Storage of motor vehicle equipment . . . . . AR 850-18
- t. The internal combustion engine . . . . . TM 10-570
- u. Trailer, generator, M7 . . . . . TM 9-881



GENERATING UNIT M7

INDEX

	Page No.		Page No.
<b>A</b>			
Adjustment of governor	83-85	description	81
Air cleaner		maintenance	82
construction	82-83	maintenance allocation	43
lubrication	25	removal and installation	82
maintenance	83	trouble shooting	81-82
trouble shooting	83	Characteristics of generating unit	
Air filter, cleaning	52	M7	2-3
Allocation of maintenance	41-43	Choke, description and functioning	13
Alternator (See under Generating system)		Choke control	
Ammeter		maintenance allocation	43
description	132	removal and installation	138
installation	133	Cleaning the cooling system	54-57
maintenance allocation	43	Cold weather accessories	37
location and functioning	14	Collector ring, inspection	119-120
removal	132-133	Commutator, inspection	123
Antifreeze solutions	34	Condenser	
		installation	109
		maintenance allocation	43
		removal	107
		Coolant service	56-57
		Cooling system	
<b>B</b>		adjustment	52
Battery		cleaning	54-57
care in extreme heat	38	description	53
description	95	fan	58-59
installation	98-99	fan belt	59-60
maintenance	97	monthly inspection	23
protection under unusual conditions	34-35	protection under unusual conditions	34
removal	97-98	radiator	57-58
trouble shooting	95	thermostat	63-65
Battery cables, maintenance allocation	43	trouble shooting	53-54
Battery-charging ammeter		water pump	60-63
location and functioning	15	Crankcase, lubrication	25
maintenance allocation	43		
removal and installation	126	<b>D</b>	
Battery-charging generator		Deep water fording	39-40
functioning	99	Description	
maintenance	100-102	cooling system	
maintenance allocation	43	fan	58
removal and installation	102	radiator	57
trouble shooting	100	engine	
Battery-charging voltage regulator generator, maintenance allocation	43	accessories	45-48
Bendix spring (See under Starting motor)		construction	44-45
		functioning	48
		specifications	49
<b>C</b>			
Carburetor			
adjustment	52		

INDEX

<b>D—Cont'd</b>	<b>Page No.</b>	<b>Page No.</b>
Description—Cont'd		
engine electrical system		Distributor points, maintenance allocation . . . . . 43
battery . . . . .	95	Domestic shipment . . . . . 144
spark plugs . . . . .	109	
engine lubrication system		<b>E</b>
oil pump . . . . .	91-92	Echelon duties . . . . . 41-42
oil strainer . . . . .	91	Engine
exhaust system		description . . . . . 44-49
exhaust pipe . . . . .	70-71	lubrication . . . . . 32-33
manifold . . . . .	67	maintenance . . . . . 50
frame . . . . .	44	monthly inspection . . . . . 23
fuel system		trouble shooting . . . . . 49-50
carburetor . . . . .	81	tune-up . . . . . 50-52
fuel pump . . . . .	77	Engine and generator controls . . 13-16
generating system		Engine electrical system
alternator . . . . .	117	battery . . . . . 95-99
exciter . . . . .	120	battery-charging generator . . . 99-102
instrument panel and instruments		description . . . . . 94
ammeter . . . . .	132	distributor . . . . . 105-109
battery-charging ammeter . . . 127		ignition coil . . . . . 103-105
choke control . . . . .	138	monthly inspection . . . . . 23-24
field rheostat . . . . .	134	protection under unusual condi- tions . . . . . 34-35
fuel gage . . . . .	130	spark plugs . . . . . 109-110
fuse block . . . . .	140	starting motor . . . . . 110-114
ignition switch . . . . .	134	trouble shooting . . . . . 95
load switch . . . . .	134	Engine lubrication system
meter switch . . . . .	133	description . . . . . 89
oil pressure gage . . . . .	127	filter . . . . . 90-91
125-volt light receptacle . . . . 135		oil pump . . . . . 91-92
125-volt light switch . . . . . 135		strainer . . . . . 91
6-volt extension cord recepta- cle . . . . .	137	trouble shooting . . . . . 89-90
6-volt light receptacle . . . . . 136		Exciter (See under Generating sys- tem)
6-volt light switch . . . . .	136	Exhaust pipe
starter switch . . . . .	133	description . . . . . 70-71
T-slot receptacle . . . . .	138	maintenance . . . . . 71
tachometer . . . . .	130-132	maintenance allocation . . . . . 43
temperature gage . . . . .	128	removal and installation . . . . . 71
terminal block . . . . .	140	Exhaust system
throttle control . . . . .	137	description . . . . . 65-67
voltmeter . . . . .	132	exhaust pipe . . . . . 70-71
Differences among models of gener- ating units . . . . .	3	flexible tube . . . . . 72
Distributor		manifold . . . . . 67-70
lubrication . . . . .	28	monthly inspection . . . . . 23
maintenance . . . . .	51	muffler . . . . . 71-72
maintenance allocation . . . . . 43		trouble shooting . . . . . 67
protection under unusual condi- tions . . . . .	34	
trouble shooting . . . . .	105	

**GENERATING UNIT M7**

<b>F</b>	<b>Page No.</b>	<b>G</b>	<b>Page No.</b>
Fan		Generator and exciter, care in	
description	58	flooded areas	38-39
installation	59	Generator and exciter shaft bearings, lubrication	28
maintenance	58	Generator and starter, protection under unusual conditions	34
maintenance allocation	43	Generating system	
removal	58-59	alternator	
trouble shooting	58	description	117
Field rheostat		maintenance	119-120
description	134	trouble shooting	117-119
functioning	13	description	114-115
maintenance allocation	43	exciter	
Fire extinguisher, operation and maintenance	31	description	120
Flexible tube, description	72	maintenance	120-123
Flood conditions	38-39	trouble shooting	120
Frame, description, trouble shooting, and maintenance	44	monthly inspection	24
Frame and canopy, monthly inspection	23	30-ampere power receptacle	123
Frequency meter, location and functioning	16	trouble shooting	115-117
Fuel gage		200-ampere power receptacle	123
maintenance allocation	43	Generating unit M7	
removal and installation	130	characteristics	2-3
Fuel pump		data	3
cleaning	51	differences among models	3
description	77	Governor	
maintenance	79	adjustment	83-85
maintenance allocation	43	trouble shooting	83
removal and installation	79		
trouble shooting	77-79	<b>I</b>	
Fuel system		Ignition coil	
air cleaner	82-83	installation	103-105
carburetor	81-82	maintenance	103
care in desert conditions	38	removal	103
description	73	Ignition switch	
fuel pump	77-79	description	134
fuel tank	76	installation	135
governor	83-85	operation and controls	13
monthly inspection	23	removal	134
throttle box	85	Ignition system	
trouble shooting	73-76	care in flooded areas	39
Fuel tank		care in humid atmospheres	38
care in extreme heat	38	Inspection	
maintenance	76	after long operation	22
Functioning of generating system	114-115	after short operation	22
Fuse block, description	140	during operation	21
		prestarting	21
		weekly and monthly	22-24

INDEX

I—Cont'd	Page No.		Page No.
Instrument panel and instruments		Lubrication system	
ammeter . . . . .	132-133	care in desert conditions . . . . .	38
battery-charging ammeter . . . . .	127	monthly inspection . . . . .	23
choke control . . . . .	138		
field rheostat . . . . .	134	<b>M</b>	
fuel gage . . . . .	130	Maintenance	
fuse block . . . . .	140-141	cold weather . . . . .	32
ignition switch . . . . .	134-135	cooling system	
instrument panel . . . . .	125	fan . . . . .	58
lamp-dimming rheostat . . . . .	136	radiator . . . . .	58
load switch . . . . .	134	thermostat . . . . .	65
meter switch . . . . .	133	water pump . . . . .	61
monthly inspection . . . . .	24	engine electrical system	
oil pressure gage . . . . .	127-128	battery . . . . .	97
125-volt light receptacle . . . . .	135	battery-charging genera-	
125-volt light switch . . . . .	135	tor . . . . .	100-102
6-volt extension cord receptacle . . . . .	137	distributor . . . . .	106-107
6-volt light receptacle . . . . .	136	ignition coil . . . . .	103
6-volt light switch . . . . .	136-137	spark plugs . . . . .	109-110
starter switch . . . . .	133	starting motor . . . . .	113
tachometer . . . . .	130-132	engine lubrication system	
temperature gage . . . . .	128-130	oil filter . . . . .	90
terminal block . . . . .	140	oil pump . . . . .	92
throttle control . . . . .	137-138	oil strainer . . . . .	91
T-slot receptacle . . . . .	138-140	exciter . . . . .	120-123
voltmeter . . . . .	132	fire extinguisher . . . . .	31
Intake and exhaust manifolds,		frame . . . . .	44
maintenance allocation . . . . .	42	fuel system	
Intervals of lubrication . . . . .	25	air cleaner . . . . .	83
		carburetor . . . . .	82
<b>L</b>		fuel pump . . . . .	79
Lamp-dimming rheostat		fuel tank . . . . .	76
location and functioning . . . . .	16	manifold . . . . .	67
removal and installation . . . . .	136	muffler . . . . .	71
Light receptacles, maintenance		terminal block . . . . .	140
allocation . . . . .	43	Manifold	
Lighting switch, maintenance allo-		description . . . . .	67
cation . . . . .	43	installation . . . . .	69-70
Limited storage . . . . .	147	maintenance . . . . .	67
Load switch		removal . . . . .	67-69
description . . . . .	134	Metal surfaces, painting . . . . .	142
location and functioning . . . . .	14-15	Meter switch	
Lubricating devices, painting . . . . .	143	description . . . . .	133
Lubrication		functioning . . . . .	13
lubrication guide . . . . .	25-28	Muffler	
points serviced by ordnance per-		construction . . . . .	71
sonnel . . . . .	28	installation . . . . .	72
reports and records . . . . .	28-29	maintenance . . . . .	71
		maintenance allocation . . . . .	43

**GENERATING UNIT M7**

<b>O</b>	Page No.	<b>P</b>	Page No.
Oil filter		Paint (-ing)	
installation	91	as camouflage	142-143
lubrication	25	lubricating devices	143
maintenance	90	metal surfaces	142
removal	90	preparation for	141-142
Oil gage, maintenance allocation	43	removal	143
Oil lines and fittings, maintenance allocation	43	Prestarting inspection	21
Oil pressure gage			
description	127	<b>R</b>	
installation	128	Radiator	
location and functioning	15	description	57
removal	127	maintenance	58
Oil pump		trouble shooting	57
description	91-92	Rail shipment	145-147
maintenance	92	Reports and records of lubrication	28-29
Oil strainer			
maintenance allocation	43	<b>S</b>	
removal and installation	91	6-volt extension cord receptacle, removal and installation	137
Oilcan points	28	6-volt light receptacle, removal and installation	136
125-volt light receptacle, description	135	6-volt light switch	
125-volt light switch, removal and installation	135	description	136
Operating the unit	18-19	installation	137
Operation (See also Operation and controls)		Spark plugs	
fire extinguisher	31	description	109
under unusual conditions		maintenance	109-110
cold weather accessories	37	maintenance allocation	42
cold weather maintenance	32	protection under unusual conditions	34
deep water fording	39-40	removal and installation	110
desert conditions	38	trouble shooting	109
engine lubrication	32-33	Starter, maintenance allocation	43
extreme heat	37-38	Starter switch	
flood conditions	38-39	location and functioning	13
gasoline for low temperatures	32	maintenance allocation	43
general conditions	35-36	removal and installation	133
protection of cooling system	34	Starting motor	
protection of electrical system	34-35	Bendix spring	
starting and operation	36-37	installation	113-114
Operation and controls		maintennace allocation	43
engine and generator controls	13-16	removal	113
general care and precautions	19-20	functioning	110
operating the unit	18-19	maintenance	113
preparation for first operation of generating unit	11-13	removal and installation	113
starting the unit	16-18	trouble shooting	110
stopping the unit	19	Starting the unit	16-18
		Stopping the unit	19



TECHNICAL MANUAL

GENERATING UNITS M7, M7A1, AND M15A1

CHANGES }  
 No. 1 }

WAR DEPARTMENT  
 WASHINGTON 25, D. C., 9 July 1945

TM 9-618, 30 July 1943, is changed as follows:

Title of the manual is changed to read: GENERATING UNITS M7, M7A1, AND M15A1.

1. SCOPE.

\* \* \* \* \*

b. In addition to descriptions of generating units M7, M7A1, and M15A1, this manual contains technical information required for the identification, use, and care of the matériel.

\* \* \* \* \*

e. (Added.) Throughout the manual all statements concerning generating unit M7 will be understood to apply also to generating units M7A1 and M15A1 unless the contrary is stated or the two are treated separately.

2. CHARACTERISTICS.

a. Generating units M7, M7A1, and M15A1 are gasoline engine driven generators mounted on specially designed rubber-tired trailers or on wood skids. Trailer-mounted generators are bolted to the floor of the trailer. The engine and \* \* \* within the canopy (figs. 4 and 5).

\* \* \* \* \*

d. Some generating units M1, M7A1, and M15A1 are mounted on generator skids M1 instead of on a trailer. The skids are \* \* \* it is carried.

3. DIFFERENCES AMONG MODELS.

a. Generating Unit M7. Generating units M7 \* \* \* the generator rotor.

\* \* \* \* \*

---

\*This change has been limited to coverage of the basic differences among generating units M7, M7A1, and M15A1 which are the addition of a voltage regulator M1 for generating unit M7A1 and M15A1 and the use of a new generator M3 for generating unit M15A1. This change does not take into account the numerous minor manufacturing changes since publication of TM 9-618 because an attempt to include them would result in a voluminous change more in the nature of a revision.

c. **Generating Unit M15A1** (Added). Generating units M15A1 are similar to generating units M7A1 except for the generator. They are equipped with generators M3.

Figure 1—Generating Units M7, M7A1, and M15A1—Left Front

Figure 2—Generating Units M7, M7A1, and M15A1—Right Rear

Figure 3—Generating Units M7, M7A1, and M15A1 and Generator Trailer M7—Ready To Be Moved

Figure 4—Generating Units M7, M7A1, and M15A1 and Generator Trailer M7—All Doors Open

## 6. ENGINE AND GENERATOR CONTROLS (figs. 8 and 8.1).

\* \* \* \* \*

d. **Field Rheostat.** The field rheostat \* \* \* the voltage delivered. This is the only method of controlling the voltage on generating unit M7. On generating units M7A1 and M15A1, the field rheostat is used to control the voltage when the voltage regulator is inoperative or turned to "MANUAL" position.

\* \* \* \* \*

k. **Tachometer.** The tachometer, which \* \* \* number of revolutions. Generating units which are equipped with a frequency meter have no tachometer.

## 8. OPERATING THE UNIT.

a. **Load Switch.** The first step \* \* \* the "ON" position. **Caution:** When energizing a cable system, be sure the generating unit is idling when the switch is turned "ON," then slowly push the throttle all the way in. Sudden energizing of system by turning switch from "OFF" to "ON" with generator unit running at rated speed may damage certain director parts.

### b. Voltage Control.

(1) **GENERATING UNIT M7.** To provide the \* \* \* voltmeter indicated 125.

(2) **GENERATING UNITS M7A1 AND M15A1 (Added).** Ascertain that the voltage regulator switch is in "AUTOMATIC" position. Slowly rotate the field rheostat handle in the "increase" direction as far as it will go. It is possible to operate the unit with the voltage regulator switch in "MANUAL" position. When doing so, turn field rheostat handle just far enough to make voltmeter register 125 volts.

### e. Trouble Lights.



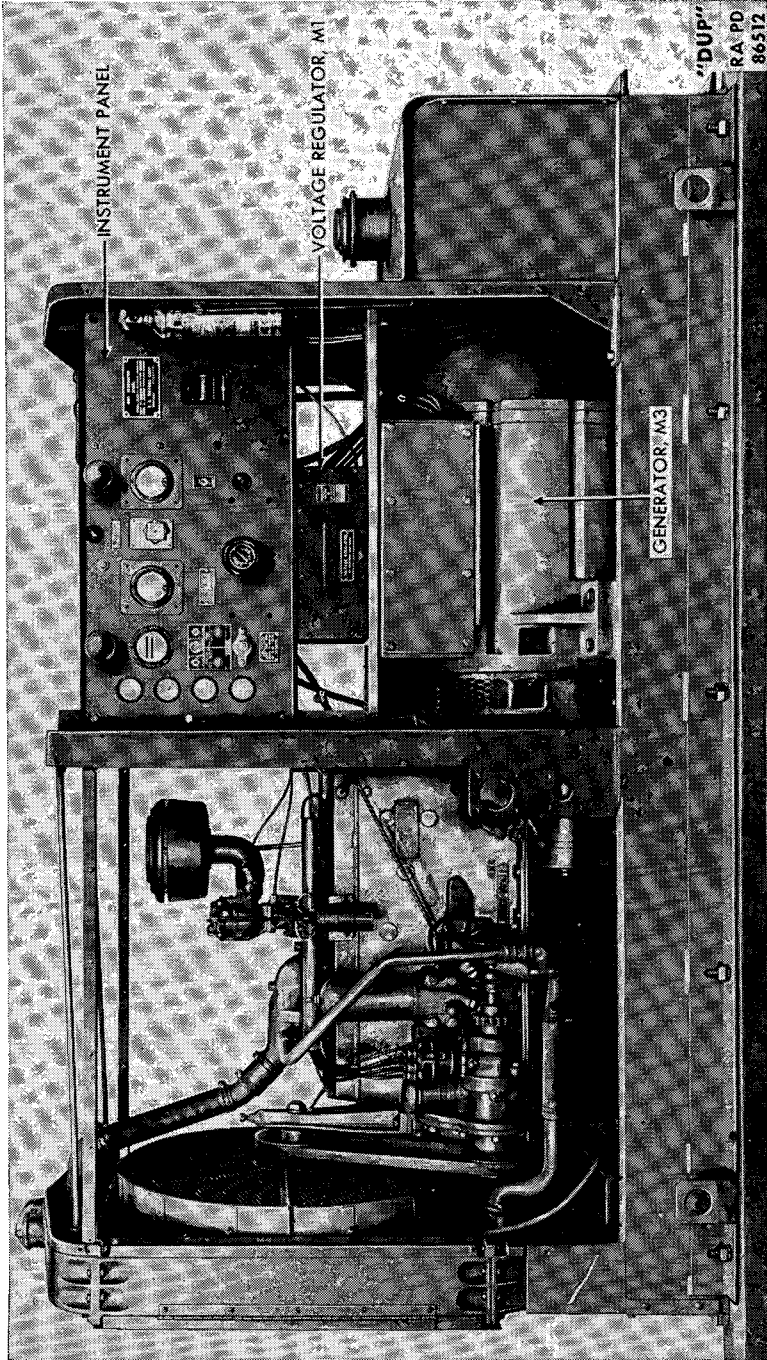


Figure 7.1 (Added)—Generating Unit M15A1—Doors, Hood, and Panels Removed—  
Left Side

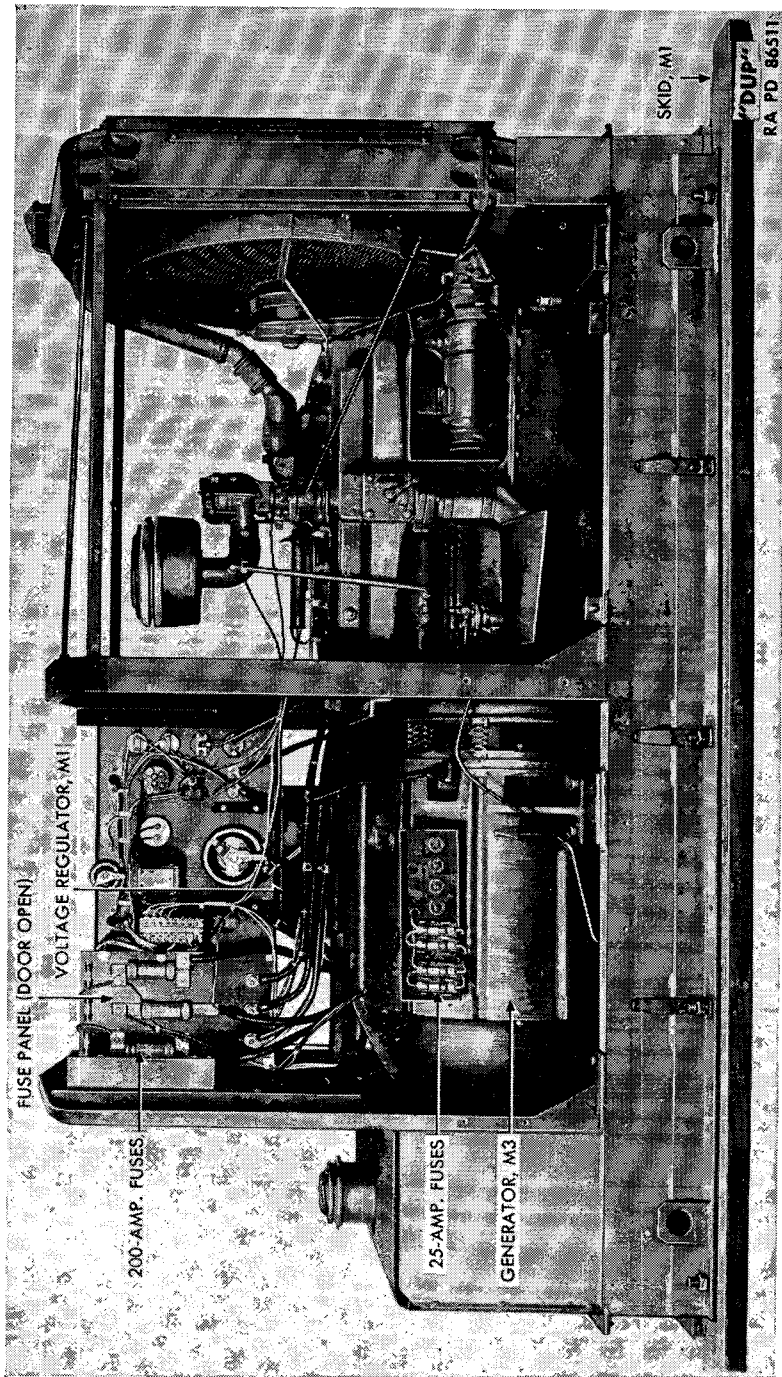


Figure 7.2 (Added)—Generating Unit M15A1—Doors, Hood, and Panels Removed—  
Right Side

Figure 8—Instrument Panel—Generating Units M7 and M7A1

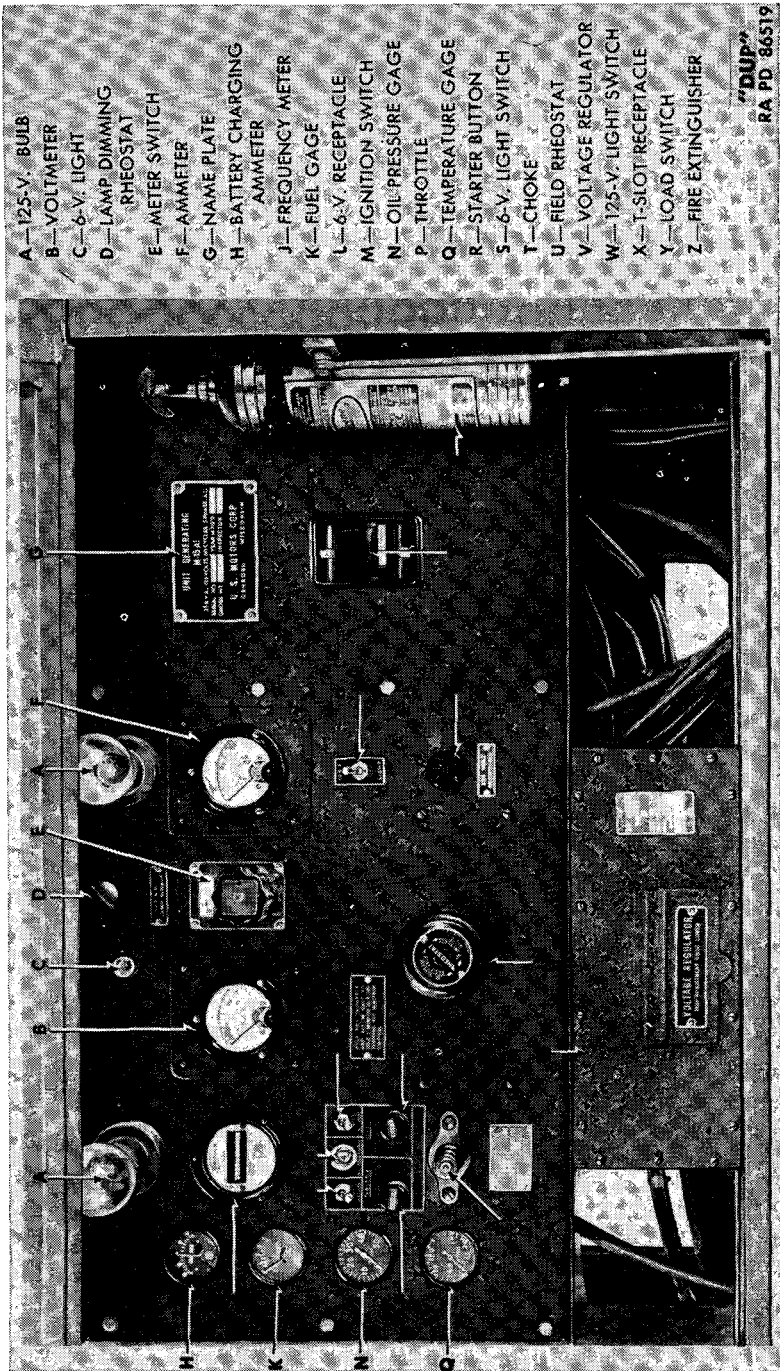


Figure 8.1 (Added)—Instrument Panel—Generating Unit M15A1

(1) The 115-volt trouble light, furnished with the unit and carried in the tool box, may be plugged into the T-slot receptacle on the panel.

(2) The 6-volt trouble \* \* \* the starter switch.

**f. Power Tools.** Power tools that may be used for repair or maintenance work on the unit can be plugged into one of the T-slot receptacles, which are below the instrument panel, or on some units, below the battery.

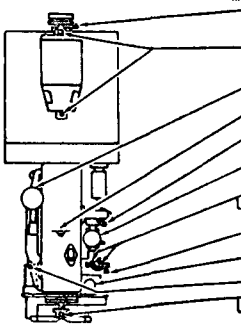
\* \* \* \* \*

# LO 9-618

**WAR DEPARTMENT LUBRICATION ORDER**  
 30 JANUARY 1945 (Supersedes WDLO 121, 21 March 1944)

## UNIT, GENERATING, M7, M7A1, M15, M15A1

References: ORD 7 SNL F-226, TM 9-418



**Interval • Lubricant**

- 200 GL** Generator Shaft Bearing  
Refill cap, turn 1 full turn (Some models) (For disassembly, see ORD Note)
- 200 GL** Exciter Shaft Bearings  
(Some models) Refill caps, turn 1 full turn (For disassembly, See ORD Note)
- 8 OE** Air Cleaner  
Check level (See Note)
- 50** Crankcase Drain  
Drain and refill (See Note) Cap. 7 qt.
- 8 WP** Water Pump  
Refill cap, turn 1 full turn
- 50** Oil Filter  
Drain and clean (See Note)
- 50 OE** Distributor Shaft & to 8 drops
- 200** Distributor (See Note)
- 50 CG** Tachometer Drive  
Refill cap, turn 1 full turn
- 8 OE** Crankcase Fill and Level  
Check level (See Note)
- 50 OE** Generator & to 8 drops
- 50 WF** Fan (plug, some models)
- 50 OE** (Oil Cup, some models) (See Note)

**NOTES AND KEY**

Clean fittings before lubricating. Lubricate after washing. Intervals are based on actual hours of operation under normal conditions. Reduce under severe conditions. Extend when not in use.

Clean parts with SOLVENT, dry cleaning, or Oil. Fuel. Diesel Dry before lubricating.

**AIR CLEANER**—Fill oil reservoir to head level with used crankcase oil or OE above 0°F., or OE (SAE 10) below 0°F. Every 150 hours remove assembly. Clean entire air cleaner and air pipes.

**CRANKCASE**—Drain only when engine is hot. Refill to FULL mark on gage. Run engine a few minutes and recheck oil level.

**CRANKCASE BELOW 0°F.**—If heated storage, winterization kit or heater are available or oil can be drained after operation, use OE (SAE 10) undiluted. Otherwise, dilute as follows: Add OE (SAE 10) to FULL mark. Then add 2 qt. gasoline. Run engine 5 to 10 minutes. Mark new higher level on dipstick with file. During operation add OE (SAE 10) to regular FULL mark as required. CAUTION. Check level every 4 hours of operation. After operation, check level. If level is below regular FULL mark, add OE (SAE 10) to regular FULL mark. Then add gasoline to new higher level mark. If level is at or above regular FULL mark, add gasoline to new higher level mark. Run engine 5 to 10 minutes to mix oil and diluent.

**OIL FILTER**—Before draining crankcase oil, remove plug and filter which covers the oil reversing valve and, with the engine running, drain 2 qt. of oil. Stop engine and drain crankcase. After draining, remove filter shell and scrape sludge from filter legs. Clean filter shell and reassemble.

**FAN**—If grease lubricated, remove plug and insert fitting to lubricate fan bearings. Replace plug. If oil lubricated, use hand oiler.

**DISTRIBUTOR**—Every 200 hours, wipe distributor breaker cam lightly with CG and lubricate breaker arm pivot, wick under rotor and generator weight pivots and slots with 1 to 2 drops of OE.

**OIL CAN POINTS**—Every 50 hours, lubricate camshaft bearing, water pump drive chain, head hinges and latches with OE.

**DO NOT LUBRICATE**—Governor Flexible Coupling.

**DISASSEMBLED PERIODICALLY BY ORDNANCE PERSON:**  
 MEL—Generator and Exciter Shaft Bearings (some models).  
 Searer.

Copy of this Lubrication Order will remain with the equipment at all times; instructions contained therein are mandatory and supersede all conflicting lubrication instructions dated prior to 20 January 1945.  
 [A.G. 200.8 (20 January 1945)]

By Order of the Secretary of War:  
**G. C. MARSHALL, Chief of Staff.**

Official:  
**J. A. ULIO, Major General,  
 The Adjutant General.**

LUBRICANTS	LOWEST ANTICIPATED AIR TEMPERATURES			INTERVALS	
	above +32°F.	+32°F. to 0°F.	below 0°F.		
OE—OIL, engine	above +32°F.	+32°F. to 0°F.	below 0°F.	8—8 hours or daily, whichever occurs first	
	Crankcase	SAE 30	SAE 10		See Note
	Other Points	SAE 30	SAE 10		PS
CG—GREASE, general purpose	No. 1	No. 0	No. 0	30—60 hours	
GL—GREASE, lubricating, special	—All temperatures			200—200 hours	
WP—GREASE, water pump	—All temperatures				
PS—OIL, lubricating, preservative, special					

Regulation additional Lubrication Orders in conformance with instructions and lists in FM 21-6

Figure 13.1 (Added)—WD LO 9-618

**j. Frequency Meter (Added).** Normal engine speed (1,200 rpm) and a-c frequency output (60 cycles) are indicated when the reed over the 60-line on the instrument reaches its maximum vibration, with adjacent reeds vibrating less vigorously.

**18. LUBRICATION ORDER.**

**a. General.** Lubrication instructions for this matériel are consolidated in a lubrication order (figs. 13 and 13.1). These specify the \* \* \* Generator Trailer M7.

\* \* \* \* \*

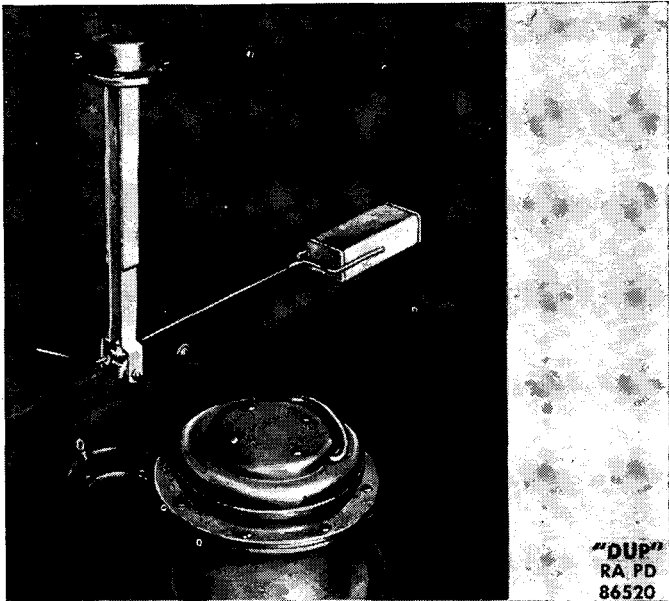


Figure 39.1 (Added)—Electric Fuel Gauge Tank Unit—Removed From Tank

**75. BATTERY (figs. 59, 60 and 60.1).**

\* \* \* \* \*

Figure 59—Instrument Panel (Rear View)—Generating Unit M7—U. S. M. Co.

Figure 60—Instrument Panel (Rear View)—Generating Unit M7—H. B. Co.

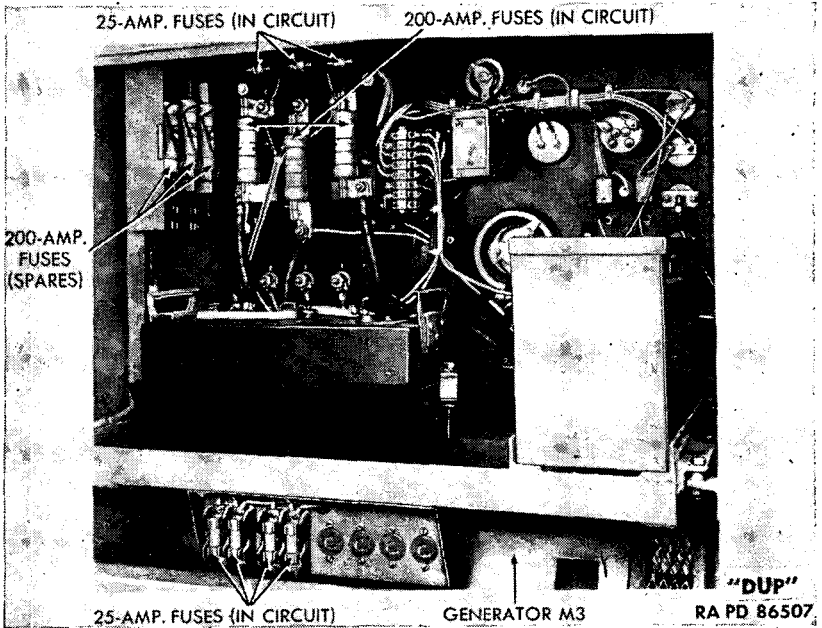


Figure 60.1 (Added)—Instrument Panel—Generating Unit M15A1—Rear View

## Section XV

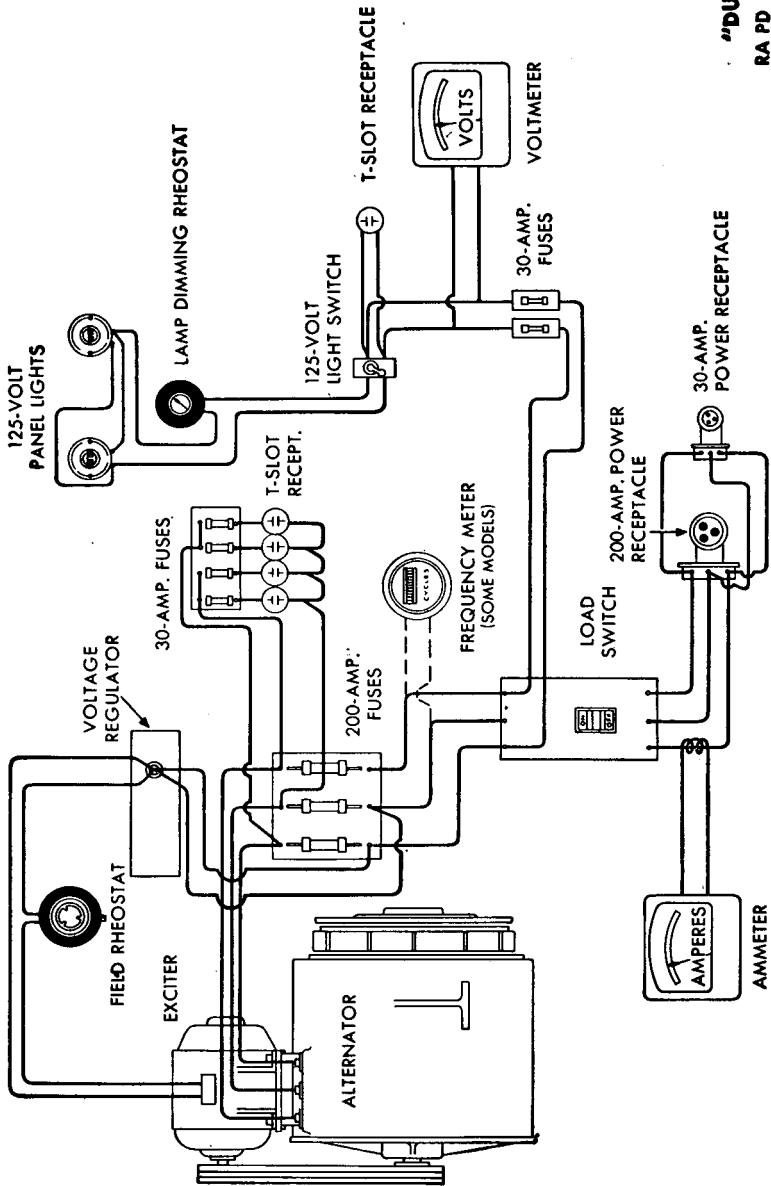
### GENERATING SYSTEM—GENERATING UNITS M7 AND M7A1

#### 81. DESCRIPTION (figs. 74 and 74.1).

a. **Construction.** The generating system \* \* \* receptacles, and fuses. In addition, generating unit M7A1 is equipped with a voltage regulator M1.

b. **Functioning.** The engine, directly \* \* \* a dimming rheostat. On generating unit M7A1, the voltage regulator automatically controls the alternator output voltage when the regulator's switch is in "AUTOMATIC" position. For a more detailed description of the voltage regulator, see paragraph 90.5.

Figure 74—Generating System—Generating Unit M7—Simplified Diagram



"DUP"  
RA PD 86510

Figure 74.1 (Added) — Generating System — Generating Unit M7A1 — Simplified Diagram

## Section XV-A (Added)

### GENERATING SYSTEM—GENERATING UNIT M15A1

#### 90.1. DESCRIPTION AND OPERATION (fig. 79.1).

a. The generating system consists of the following units: a-c generator, exciter field rheostat, load switch, voltage regulator, voltmeter, ammeter, meter switch, two instrument light sockets with lamp-dimming rheostat, two power receptacles, load terminal box, T-slot receptacle, four turn and pull receptacles, and necessary fuses and wiring. The generator, which is described in more detail in paragraph 90.2, consists of an exciter and alternator on a single shaft and inclosed in one housing. The exciter field rheostat is a conventional resistance-wire, circular type unit. It is connected in the field circuit. The load switch is connected in the "A," "B," and "C" leads from the stator of the alternator. The voltage regulator consists of both spring-loaded magnetic units and a manually-controlled unit. It is connected in the exciter field circuit in series with the field rheostat. The voltmeter and ammeter are of conventional design. They are connected into stator circuit of the alternator through the meter switch. This switch is provided to enable the operator to test the output in any of the three phases, and also the output from the exciter. All sockets and receptacles are connected into the stator circuit. They serve as the means of connecting to the generator. The lamp-dimming rheostat, similar in construction to exciter field rheostat but smaller, is connected in series with the two 120-volt instrument panel lights.

b. The engine is directly coupled to the generator shaft. Direct current to excite the alternator field coils is supplied by the exciter as required by the load. The manually-operated exciter field rheostat is used to maintain constant a-c output under varying loads when the voltage regulator switch is in "MANUAL" position. The voltage regulator is designed to hold voltage variation to within  $\pm 2$  percent from full load to no load operation. For automatic voltage regulation, the voltage regulator switch must be in "AUTOMATIC" position and the field exciter rheostat turned for maximum (or increased) voltage. Two pole receptacle and socket circuits are protected by 25-ampere fuses located on a bracket below the battery and instrument panel. The 120-volt instrument panel lights are controlled by a toggle switch and the amount of illumination given by them is controlled by the lamp-dimming rheostat.



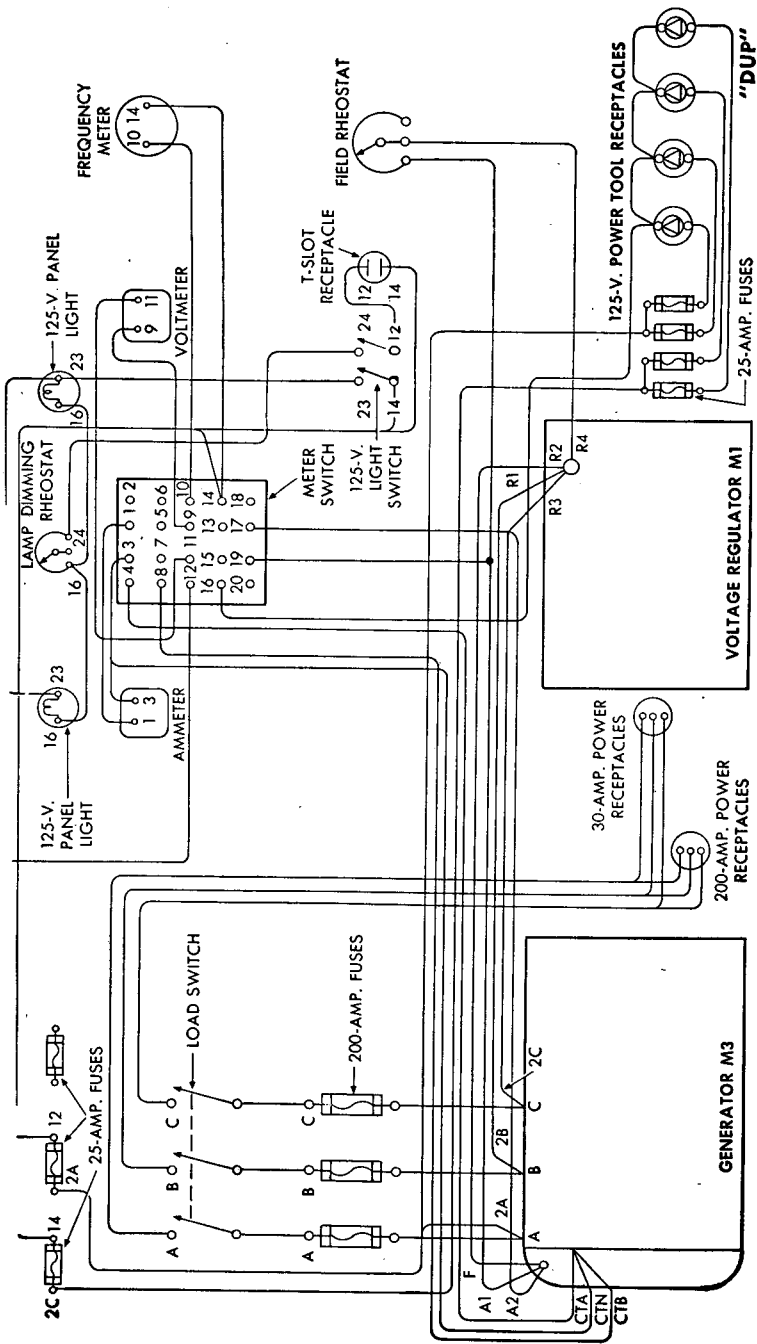


Figure 79.1—Generating System—Generating Unit M15A1—Simplified Diagram

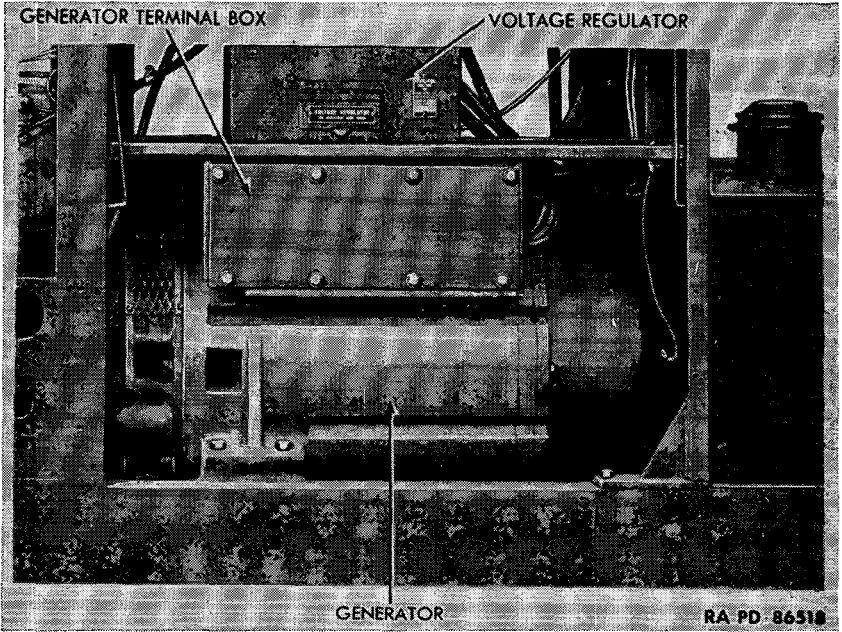


Figure 79.2—Generator M3 Installed—Left Side

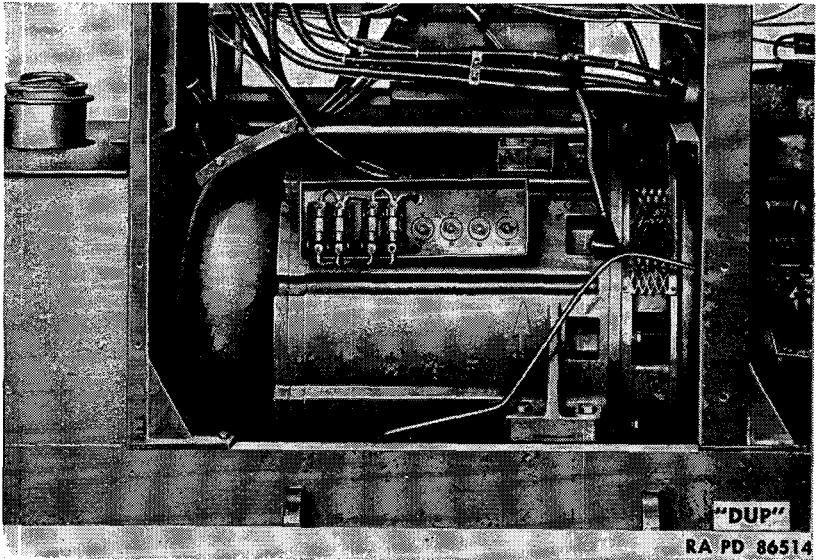


Figure 79.3—Generator M3 Installed—Right Side

## 90.2. GENERATOR M3 DESCRIPTION (figs. 79.2 and 79.3).

**a. Construction.** This generator consists of two generators mounted on the same shaft in the same housing. The smaller of the two, the exciter, is a d-c stationary field type generator. Its purpose is to furnish direct current to excite the field windings of the larger generator (the alternator). The alternator is an alternating current, revolving field type generator. Its function is to deliver the electrical output of the unit. The exciter is to the rear of the generator, while the alternator is to the front. Fans on each end of the shaft draw air through the windings to provide cooling. Generator M3 is a 3-phase, alternating-current, 60-cycle machine. At 1,200 revolutions per minute, it produces either 125- or 250-volt current, depending on how the links are connected in the generator terminal box. During 125-volt operation, it normally delivers up to 165 amperes. At 250 volts, its maximum normal capacity is 85 amperes. It is capable of delivering an overload for limited periods without damaging the generator. However, overload operation does overwork the engine and should be avoided except when absolutely necessary.

**b. Functioning.** For use with ordnance equipment, only the 125-volt output is employed. The current is obtained from the generator which converts the mechanical energy of the engine into electrical energy by means of magnetic induction. When driven at its rated

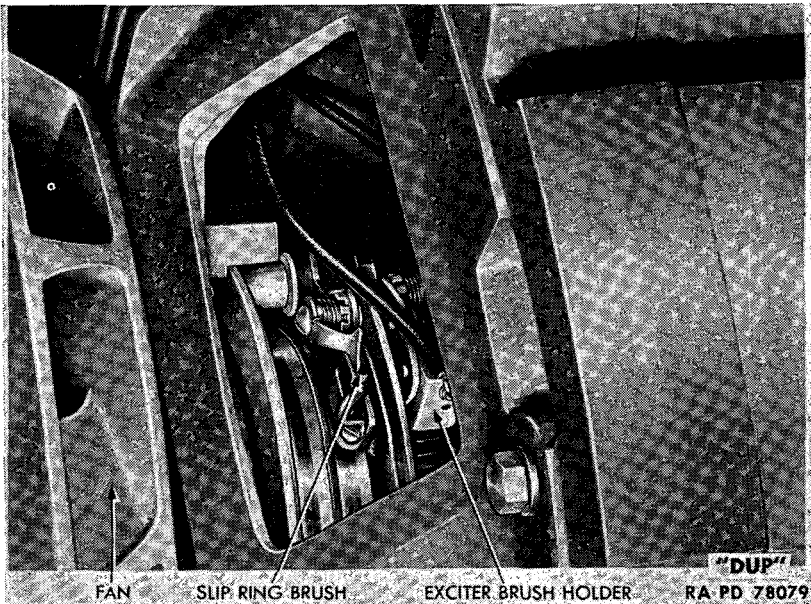


Figure 79.4—Generator M3—Brushes Installed

speed, 1,200 revolutions per minute, the generator produces a voltage at its terminals equivalent to that provided by a usual 125-volt lighting circuit. This voltage can be varied over a range of 90 to 150 volts by use of the exciter field rheostat.

### 90.3. TROUBLE SHOOTING.

#### a. Commutator Brushes Arc Severely.

Cause	Remedy
Dirt on commutator.	Clean commutator.
Worn brushes.	Replace brushes.
Brushes stuck in holder.	Remove and clean brushes. Straighten holder if bent.
Open circuit in armature coil in exciter.	Refer to ordnance maintenance personnel.
High mica between commutator segments of exciter.	Refer to ordnance maintenance personnel.

#### b. Fails to Generate Rated Voltage When Output Current Is normal.

Cause	Remedy
Voltage regulator out of adjustment, or defective.	Adjust voltage regulator. (See par. 90.5c(3).) If adjustment cannot be made, refer to ordnance maintenance personnel.
Exciter commutator dirty.	Clean commutator by holding No. 00 sandpaper against it. Pull dust from generator with dry compressed air.
Worn commutator brushes.	Replace worn brushes.
Burned out fuse.	Test fuses and replace those which are burned out.
Internal defect in generator.	Notify ordnance maintenance personnel.

#### c. Fails to Operate at Proper Frequency.

Cause	Remedy
Incorrect engine speed.	Adjust engine governor for an engine speed of 1,200 revolutions per minute.

#### d. Generator Delivers No Voltage.

Cause	Remedy
Load switch turned off.	Turn on load switch.
Voltage regulator out of adjustment.	Adjust voltage regulator. (See par. 90.5c(3).)
Open circuit in generator to field rheostat to voltage regulator circuit.	Check generator to rheostat, regulator to circuit. Replace broken wires; tighten loose connections.
Generator commutator dirty.	Clean commutator by holding No. 00 sandpaper against it. Blow dirt from generator with dry compressed air.
Commutator brushes worn, broken, or stuck in holders.	Inspect commutator brushes. Replace broken or worn brushes. Clean brushes which bind. Straighten brush holder if bent.
Fuses burned out.	Test fuses and replace those which are burned out.
Internal defect in generator.	Refer to ordnance maintenance personnel.

#### 90.4. GENERATOR M3 MAINTENANCE.

**a. Brush Inspection.** At least once every 3 months, remove brush covers (d below) and visually inspect brushes. (See fig. 79.4.) If gummy, or stuck in their holders, remove and clean brushes. Clean all dirt from the brush holders. Check tightness of all pigtail connections.

**b. Collector Ring Inspection.** Inspect collector rings whenever brush covers are removed for servicing brushes and brush holders. (To remove covers, see d below.) Note condition of surface of rings. Surface should appear smooth and clean. Scoring or roughening of collector ring surfaces may be caused by grit or abrasive in brushes, or by presence of oil on rings. Moderately rough collector rings can be corrected by holding No. 00 class B flintpaper to their surfaces while the rings are revolving. If rings are badly scored or worn, report to ordnance maintenance personnel. After cleaning collector rings, blow out dirt and grit with compressed air.

**c. Commutator Inspection.** Inspect exciter commutator whenever brush covers are removed. (To remove covers, see d below.) All bars should appear smooth and clean, and the mica undercut slightly be-

low the surface of the bars. If commutator appears moderately rough or dirty, clean by holding No. 00 class B flintpaper against it while it is slowly revolving. Badly scored commutators or commutators with uneven bars must be reported to ordnance maintenance personnel. Blow out dirt and grit from generator with compressed air.

*Note.*—Never use oil or aluminum oxide abrasive cloth on commutators.

**d. Brush Removal** (fig. 79.4).

- (1) Disconnect wire attached to trailer brake receptacle.
- (2) Unscrew nuts and screws securing generator panel to frame and remove panel.
- (3) Remove cap screws securing fan guard to generator frame. Separate fan guard by removing the attaching cap screws and nuts and lift the halves of the guard from the unit.
- (4) Using socket head screw wrench, loosen socket head screws, and lift out brush covers.
- (5) Remove screws securing brush pigtail connections to brush holders and lift out brushes.

**e. Brush installation.** When replacing brushes, it is important that they are carefully fitted to the commutator or collector rings. To fit brushes, slip a piece of No. 00 class B flintpaper between brush and commutator or collector ring with flint surface facing brush. The paper must be of the same width as the commutator or slip ring. Following the curved surface of the commutator or slip ring, move the flintpaper back and forth until the proper brush surface is obtained. Procedure for brush installation is the reverse of d above.

**90.5. VOLTAGE REGULATOR M1** (fig. 79.5).

**a. Description.** A voltage regulator M1 is attached to the underside of the instrument panel. It is housed in a dust-tight metal box. A spring-loaded lid on the front of the box covers the switch and adjustment screw. The switch is a toggle type. Its two positions are marked "MANUAL" and "AUTOMATIC." With the switch on "MANUAL" position, the voltage regulator is removed from the circuit and the generator output must be controlled by hand by means of the field rheostat. Placing the switch in "AUTOMATIC" position puts the voltage regulator into the alternator and exciter circuits of the generator. The alternator output operates the voltage regulator. The voltage regulator, in turn, regulates the output of the exciter. The exciter output regulates the voltage generated by the alternator. In this manner, the voltage is controlled automatically to within  $\pm 2$  percent. The adjustment screw is provided to raise or lower the volt-

age. Four leads from the back of the voltage regulator box serve to connect the assembly into the circuit.

**b. Trouble Shooting. Caution:** If necessary to service voltage regulator while generating unit is in operation, stand on a dry board and shift voltage from "AUTOMATIC" to "MANUAL" operation.

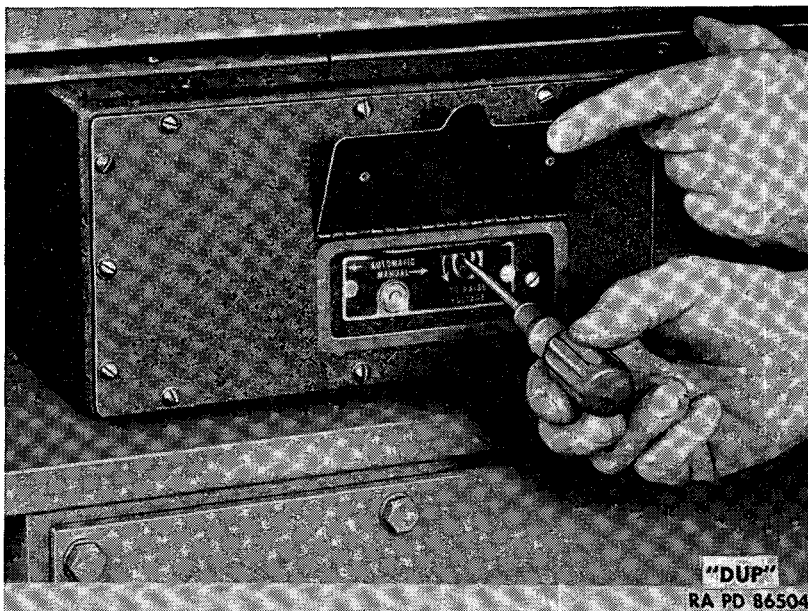


Figure 79.5 (Added)—Voltage Regulator Adjustment

(1) VOLTAGE VARIES WIDELY FROM DESIRED VOLTAGE.

Cause	Remedy
Butterfly valve in throttle box is binding.	Replace throttle assembly or refer to ordnance maintenance personnel for cleaning and lubrication.
"AUTOMATIC - MANUAL" switch is in "MANUAL" position.	Place "AUTOMATIC" switch in automatic position.
Field rheostat is not completely eliminated from circuit.	Turn field rheostat handle all the way in the "increase" direction.
Voltage regulator out of adjustment.	Check setting of voltage adjusting screw.
Internal disorder in voltage regulator.	Refer to ordnance maintenance personnel.

(2) VOLTAGE FAILS TO BUILD UP.

Cause	Remedy
Commutator or brushes dirty or worn.	Inspect commutator and brushes; clean, repair, or replace as necessary.
Exciter driving belt loose (M7A1 unit only).	Adjust exciter driving belt.
Open circuit in field rheostat or in wiring to rheostat.	Repair or replace broken or disconnected wires.
Voltage regulator out of adjustment.	Check setting of voltage adjusting screw.
Internal defect in voltage regulator.	Refer to ordnance maintenance personnel.

(3) VOLTAGE BECOMES ERRATIC.

Cause	Remedy
Loose connections in wiring to voltage regulator or elsewhere in generating circuit.	Check all connections for tightness and freedom from corrosion.
Internal defect in voltage regulator.	Refer to ordnance maintenance personnel.

(4) VOLTAGE REGULATION IS POOR.

Cause	Remedy
Field rheostat is not entirely eliminated from circuit.	Turn field rheostat handle as far as it will go in the "increase" direction.
Loose connection in circuit to voltage regulator.	Check wiring to regulator and tighten all loose connections.
Internal defect in voltage regulator.	Refer to ordnance maintenance personnel.

(5) VOLTAGE DROPS EXCESSIVELY UPON APPLICATION OF HEAVY LOAD.

Cause	Remedy
"AUTOMATIC - MANUAL" switch is in "MANUAL" position.	Place "AUTOMATIC" switch in "AUTOMATIC" position.
Field rheostat not entirely eliminated from circuit.	Turn field rheostat handle as far as it will go in the "increase" direction.
Internal defect in voltage regulator.	Refer to ordnance maintenance personnel.



**c. Adjustment** (fig. 79.5).

(1) Set the main power switch in "OFF" position. Start the generating unit and allow it to warm up. Turn the field rheostat handle all the way to short out all rheostat resistance. In this position the voltage would be at its maximum if the voltage regulator were not in service.

(2) Place the "AUTOMATIC-MANUAL" switch on the front panel of the voltage regulator in "AUTOMATIC" position.

(3) Adjust the output voltage to desired amount (normally 125 volts) by turning adjustment screw marked "TO RAISE VOLTAGE."

*Note.* It is not necessary to switch the "AUTOMATIC-MANUAL" switch from "AUTOMATIC" to "MANUAL," or vice versa, when starting or stopping the unit. The voltage regulator automatically starts and stops with the generator, and may be left either in service or out of service.

**d. Maintenance.** Keep regulator mounting screws tight at all times. Inspect wiring in circuit to voltage regulator at frequent intervals to see if the insulation is in good condition and all connections are tight. Do not permit grease or oil to seep into regulator:

**90.6. POWER RECEPTACLES** (fig. 79).

Generating unit M15A1 is equipped with power receptacles identical to those used on generating units M7 and M7A1. Description and maintenance are given in paragraphs 89 and 90.

**91. INSTRUMENT PANEL** (figs. 8, 60.1, 80 and 82).

\* \* \* \* \*

Figure 80—Instrument Panel—U. S. M. Co.—Generating Unit M7

Figure 82—Instrument Panel—Generating Unit M7—Rear View

**96.1 FREQUENCY METER** (Added).

The frequency meter is located to the left of the voltmeter on the instrument panel. It is a vibrating reed type instrument and registers the number of cycles per second at which the current is alternating. Its range is from 57 to 63 cycles.

**114. FUSE BLOCK** (fig. 89).

Two double-fuse \* \* \* instrument panel apron. On generating unit M15A, 25-ampere fuses are attached to a bracket below the tool box and battery or below the instrument panel.

\* \* \* \* \*

[AG 300.7 (5 May 45)]

BY ORDER OF THE SECRETARY OF WAR:

OFFICIAL:

EDWARD F. WITSELL

*Major General*

*Acting The Adjutant General*

G. C. MARSHALL

*Chief of Staff*

DISTRIBUTION:

AAF (10); AGF (5); ASF (2); Dept (10); AAF Comd (2);  
Arm & Sv Bd (1); S Div ASF (1); Tech Sv (2); SvC  
(10); PC&S (1); PE, 9 (5); Dist O, 9 (5); Dist Br O,  
9 (3); Reg O, 9 (3); Establishment, 9 (5); Decentralized  
Sub-O, 9 (3); Gen & Sp Sv Sch (10); USMA (20); A (10);  
CHQ (10); D (2); AF (2); T/O & E 9-7 (3); 9-9 (3);  
9-57 (3); 9-65 (2); 9-67 (3); 9-76 (2); 9-318 (3); 9-377  
(3); 44-115 (2); 44-117 (3).

Refer to FM 21-6 for explanation of distribution formula.