

~~858.7~~
~~13~~

FM 6-70

WAR DEPARTMENT

FIELD ARTILLERY
FIELD MANUAL

SERVICE OF THE PIECE
75-MM HOWITZER, HORSE AND
TRUCK-DRAWN

U.S. Army Military History Institute

Withdrawn from Creer Library

FM 6-70

**FIELD ARTILLERY
FIELD MANUAL**

**SERVICE OF THE PIECE
75-MM HOWITZER, HORSE AND
TRUCK-DRAWN**

Prepared under direction of the
Chief of Field Artillery



**UNITED STATES
GOVERNMENT PRINTING OFFICE
WASHINGTON : 1939**

For sale by the Superintendent of Documents, Washington, D. C.
Price 10 cents

WAR DEPARTMENT,
WASHINGTON, October 14, 1939.

FM 6-70, Field Artillery Field Manual, Service of the Piece—75-mm Howitzer, Horse and Truck-drawn, is published for the information and guidance of all concerned.

[A. G. 062.11 (6-17-39).]

BY ORDER OF THE SECRETARY OF WAR:

G. C. MARSHALL,
Chief of Staff.

OFFICIAL:

E. S. ADAMS,
Major General,
The Adjutant General.

TABLE OF CONTENTS

	Paragraph	Page
SECTION I. General:		
Purpose and scope.....	1	1
References.....	2	1
Definitions and terms.....	3	1
SECTION II. Organization:		
Composition.....	4	2
Formation.....	5	3
SECTION III. Posts; mounting and dismounting:		
Posts of the howitzer squad.....	6	4
To post the howitzer squads.....	7	4
Posts of the cannoneers.....	8	6
To post the cannoneers.....	9	6
To mount the cannoneers.....	10	7
To dismount the cannoneers.....	11	7
SECTION IV. Movements of the carriages by hand:		
Limbered or coupled.....	12	8
Unlimbered or uncoupled.....	13	8
SECTION V. Unlimbering and limbering:		
Unlimbering.....	14	9
Limbering.....	15	12
SECTION VI. Uncoupling and coupling:		
Uncoupling.....	16	13
Coupling.....	17	14
SECTION VII. Preparation for action and march order:		
To prepare for action.....	18	15
Posts of the cannoneers, carriages unlimbered (uncoupled).....	19	18
March order.....	20	19
SECTION VIII. Duties in firing:		
General.....	21	22
Chief of section.....	22	22
Gunner.....	23	27
No. 1.....	24	30
No. 2.....	25	31
No. 3.....	26	32
No. 4.....	27	34
No. 5.....	28	36
SECTION IX. Additional information on the service of the piece:		
Accuracy in laying.....	29	38
To fire by individual sections with direct laying at moving targets.....	30	38
Fire at will.....	31	39
Aiming stakes.....	32	39
Correction for lateral displacement.....	33	40
Reporting errors.....	34	40
Cease firing.....	35	40
Suspend firing.....	36	40
Changes in data during firing.....	37	41

TABLE OF CONTENTS

	Paragraph	Page
SECTION IX—Continued.		
To unload the piece.....	38	41
Misfires.....	39	41
Ammunition.....	40	42
The section data board.....	41	42
Firing from the wheels.....	42	42
SECTION X. Care and maintenance of matériel:		
General.....	43	42
Cleaning.....	44	43
Lubrication.....	45	45
Protection against chemicals.....	46	48
Recoil mechanism.....	47	48
Tube assembly, breech mechanism, and firing mechanism.....	48	50
Wheels and brakes.....	49	52
Miscellaneous parts of carriage.....	50	53
Sighting and fire-control equipment.....	51	54

FIELD ARTILLERY FIELD MANUAL

SERVICE OF THE PIECE

75-MM HOWITZER, HORSE AND TRUCK-DRAWN

SECTION I

GENERAL

- 1. **PURPOSE AND SCOPE.**—This manual prescribes the duties to be performed in the service of the piece by the personnel normally assigned to one howitzer section of the firing battery.
- 2. **REFERENCES.**—*a. Description, operation, functioning, and care of matériel.*—TR 1305-A; TR 1305-75E; SNL C-26; SNL C-29.
- b. Description and operation of fire-control and sighting equipment.*—TR 1320-C (now TR 310-20); SNL F-106; SNL F-166; SNL F-169.
- c. Ammunition.*—TR 1355-75A; TR 1370-A; SNL R-1; SNL R-3.
- d. Cleaning and preserving materials.*—TR 1395-A; SNL K-1.
- e. Mounted cannoneer (horse batteries).*—FM 25-5.
- f. Field artillery driver.*—Part Two, FM 6-5.
- g. Maneuvers of the battery.*—Part Two, FM 6-5.
- h. Safety precautions in firing.*—AR 750-10; Chapter 1, FM 6-40.
- i. Firing battery.*—Chapter 1, FM 6-40.
- j. Gunnery.*—FM 6-40.
- k. Reconnaissance, occupation, and organization of position.*—Part One, FM 6-20.
- 3. **DEFINITIONS AND TERMS.**—*a. Section.*—Tables of Organization prescribe the personnel and matériel comprising a

section of a battery. In this manual the term is frequently used to designate a section of the firing battery. In this restricted sense, a howitzer section is composed of one piece and the additional matériel and the personnel required to serve that piece.

b. Limbered.—A piece (caisson) is said to be limbered when its lunette is attached to the pintle of its limber.

c. Unlimbered.—A piece (caisson) is said to be unlimbered when its lunette has been detached from the pintle of the limber and the trail (caisson prop) rests on the ground.

d. Coupled.—A piece is said to be coupled when its lunette is attached to the pintle of a truck or other prime mover.

e. Uncoupled.—A piece is said to be uncoupled when its lunette is detached from the pintle of a truck or other prime mover and the trail rests on the ground.

f. Front.—The front in a section, carriages limbered or coupled, is the direction in which the trail points; carriages unlimbered or uncoupled, the direction in which the muzzle of the piece points.

g. Right (left).—The direction right (left) is the right (left) of one facing to the front.

h. In battery.—The term "in battery" is used to designate the position of the howitzer when it is in its normal firing position.

SECTION II

ORGANIZATION

■ 4. COMPOSITION.—*a. Howitzer squad.*—A howitzer squad consists of the gunner and five cannoneers numbered from 1 to 5. The remaining cannoneers of the howitzer section act as reliefs or are assigned such other duties as the chief of section may direct. In horse batteries two, or more if necessary, of the highest-numbered cannoneers are assigned as horseholders. When the battery unlimbers or uncouples for drill or for firing, the chief of section remains at the firing position and commands the howitzer squad.

b. Ammunition squad.—(1) An ammunition squad consists of an ammunition corporal and cannoneers as prescribed in Tables of Organization. These cannoneers are numbered

consecutively, beginning with No. 1, and are assigned to the ammunition vehicles of the ammunition (fifth) section. In organizations equipped with caissons, the cannoneers are equally divided between the two caissons, the lower-numbered cannoneers being assigned to the first caisson.

(2) Posts and movements prescribed hereinafter for the howitzer squad apply, with obvious modifications, to an ammunition squad.

■ 5. FORMATION.—*a. Order of formation.*—(1) *Dismounted.*—A howitzer squad is formed as shown in figure 1. Higher-numbered cannoneers, if present, form in order on the left of No. 5.

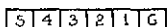

FIGURE 1.—Formation of the howitzer squad.

(2) *Mounted.*—A horse howitzer squad is formed as shown in figure 2. The interval between horses is 18 inches, the distance between ranks, 4 feet. When more than the gunner and seven cannoneers are present, three ranks are formed.

b. To form.—(1) *Dismounted.*—The place of formation is indicated and the command given thus, for example: 1. IN FRONT (REAR) OF YOUR PIECES (CAISSONS), OR 1. ON THE ROAD FACING THE PARK, 2. FALL IN. Each gunner repeats the command FALL IN and hastens to place himself, faced in the proper direction, at the point where the right of his squad is to rest. The cannoneers move at the double time and assemble at attention in their proper places. For the first formation of the howitzer squads for any drill or exercise, the caution, "As howitzer squads," precedes the command. The chief of section, if present, supervises the formation.

(2) *Mounted.*—To form a horse howitzer squad mounted, the commands are the same as those given above with the exception that LEAD OUT is substituted for the command FALL IN. The gunner moves to the point indicated and faces in the desired direction. The cannoneers lead out, form in their proper places, and STAND TO HORSE.

(3) In case the front or rear of the carriages is designated, each squad falls in at its post (par. 6).

c. To call off.—(1) *Dismounted.*—The command is: CALL OFF. The cannoneer on the left of the gunner calls off "One"; the cannoneer on the left of No. 1, "Two"; and so on.

(2) *Mounted.*—The command is: CALL OFF. The cannoneer on the right of the rear rank calls off "One"; the cannoneer on the left of the gunner, "Two"; the cannoneer on the left of No. 1, "Three"; and so on. The gunner does not call off.

(3) After having called off, if a subsequent formation is ordered, the cannoneers fall in at once in their proper order.

SECTION III

POSTS; MOUNTING AND DISMOUNTING

■ 6. POSTS OF THE HOWITZER SQUAD.—*a. Carriages limbered (without teams), or coupled.*—(1) *In front of the piece or caisson.*—The squad is in line facing to the front, its center two paces from the end of the pole or from the front of the truck.

(2) *In rear of the piece or caisson.*—The squad is in line facing to the front, its center two paces from the muzzle of the piece or from the rear of the caisson.

b. Carriages limbered (with teams).—(1) When the section is in section column, each squad is posted as shown in figure 2, its front and center 2 yards in rear of the caisson.

(2) When the section is in double section or flank column, each squad is posted on the outer flank of and 2 yards from the caisson, the front rank alined on the limbers. When three ranks are formed (par. 5b (2)), the front rank is alined on the wheel drivers.

c. Carriages unlimbered or uncoupled.—The squad is in rear of the piece, in line facing to the front, its front and center two paces from the end of the trail of the piece.

■ 7. TO POST THE HOWITZER SQUADS.—The squads having been marched to the vicinity of the carriages are posted at the command SQUADS IN FRONT (REAR) OF YOUR PIECES (CAISSONS). Each gunner marches his squad to its carriages and posts it in the position indicated.

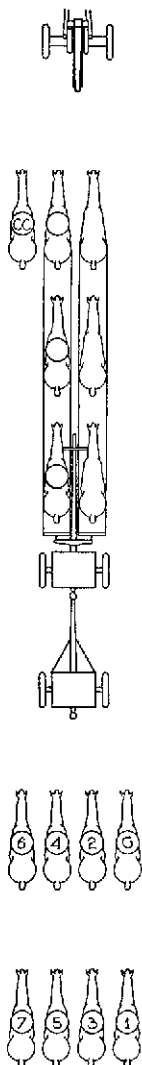

FIGURE 2.—Post of the howitzer squad mounted, in section column.

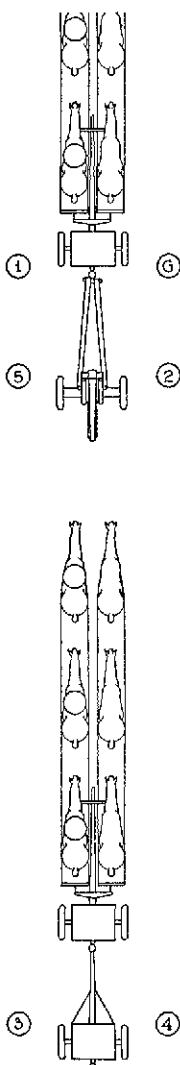

FIGURE 3.—Posts of the cannoneers, carriages limbered.

■ 8. POSTS OF THE CANNONEERS.—*a. Carriages limbered or coupled.*—The cannoneers are posted as shown in figures 3 and 4, respectively. All are 2 feet outside the wheels and facing to the front. Higher-numbered cannoneers, if present, are posted as prescribed by the chief of section.

b. Carriages unlimbered.—See paragraph 19.

■ 9. TO POST THE CANNONEERS.—*a.* The command is: 1. CANNONEERS, 2. POSTS. Each gunner repeats the command

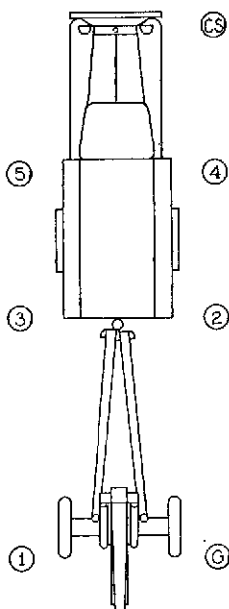

FIGURE 4.—Posts of the cannoneers, pieces coupled.

POSTS. The cannoneers leave the ranks, if formed, and move at the double time to their posts.

b. For preliminary instruction, the squads on entering the park are first posted with their carriages, and the cannoneers are then sent to their posts by the foregoing command.

The command is general, however, and is applicable when the cannoneers are in or out of ranks, at a halt or marching, and when the carriages are limbered (coupled) or unlimbered (uncoupled).

■ 10. To MOUNT THE CANNONEERS.—*a.* (1) *Horse batteries.*—In each howitzer squad the personnel is mounted as shown in figure 2.

(2) *Truck-drawn batteries.*—In each squad the personnel is seated in the truck in the order prescribed by the battery commander. The chief of section is seated beside the driver.

b. The command is: 1. CANNONEERS, PREPARE TO MOUNT, 2. MOUNT.

(1) *Horse batteries.*—The mounts of the cannoneers are in charge of horseholders 2 yards in rear or to the flank of their caissons. At the first command, the cannoneers move at the double time and prepare to mount. At the second command, they mount and form as prescribed in *a* above.

(2) *Truck-drawn batteries.*—At the first command, the cannoneers move at the double time to positions on the ground convenient for mounting the truck. At the second command, all mount as prescribed by the battery commander.

c. If the command is: 1. CANNONEERS, 2. MOUNT, the cannoneers execute at the command MOUNT all that has been prescribed for the commands CANNONEERS, PREPARE TO MOUNT and MOUNT.

■ 11. To DISMOUNT THE CANNONEERS.—*a.* The command is: 1. CANNONEERS, PREPARE TO DISMOUNT, 2. DISMOUNT.

(1) *Horse batteries.*—At the first command, the cannoneers prepare to dismount; at the second command, they dismount and stand to horse.

(2) *Truck-drawn batteries.*—At the first command, the cannoneers assume positions from which they can dismount promptly; at the second command, they jump to the ground and take their posts at the double time.

b. If the command is: 1. CANNONEERS, 2. DISMOUNT, the cannoneers execute, at the command DISMOUNT, all that has been prescribed for the commands CANNONEERS, PREPARE TO DISMOUNT and DISMOUNT.

SECTION IV

MOVEMENTS OF THE CARRIAGES BY HAND

■ 12. LIMBERED OR COUPLED.—*a. Horse batteries.*—(1) *To the front.*—The command is: 1. PIECES (CAISSONS) FORWARD, 2. MARCH, 3. HALT. In each squad at the first command the gunner and No. 1 hasten to the end of the pole; Nos. 2 and 5 to the rear of the limber chest; Nos. 3 and 4 to the rear of the piece (caisson) wheels; higher-numbered cannoneers, if present, to posts as directed by the chief of section; the gunner and even numbers working on the right side of the carriage; odd numbers on the left. When the piece is to be moved, Nos. 3 and 4 release the brakes. When the caisson is to be moved, No. 4 releases the brake; when the brake is released, Nos. 3 and 4 raise and secure the caisson prop. At the command MARCH, all assist in moving the carriage to the front. At the command HALT, the carriage is stopped. In the case of the piece, Nos. 3 and 4 set the brakes. In the case of the caisson, Nos. 3 and 4 lower the caisson prop and No. 4 sets the brake. All cannoneers resume their posts.

(2) *To the rear.*—The command is: 1. PIECES (CAISSONS) BACKWARD, 2. MARCH, 3. HALT. Executed as prescribed above, except that Nos. 2 and 5 go to the front of the limber chest and Nos. 3 and 4 go to the front of the piece (caisson), and at the command MARCH the cannoneers move the carriage to the rear.

b. Truck-drawn batteries.—The carriages are not moved by hand when coupled.

■ 13. UNLIMBERED OR UNCOUPLED.—The command is: 1. PIECES (CAISSONS) FORWARD (BACKWARD), 2. MARCH, 3. HALT.

a. Piece.—(1) *First command.*—At the first command, Nos. 3 and 4 grasp the trail handles, No. 3 on the right and No. 4 on the left; No. 2 grasps the left wheel and No. 5 the right wheel; the gunner and No. 1 place themselves adjacent to their posts, in rear of the axle in moving forward and in front of the axle in moving backward; higher-numbered cannoneers, if present, are employed as directed by the chief of section.

(2) *Second command.*—At the command MARCH, all working together move the piece forward (backward) under the direction of the chief of section. When moving up or down steep slopes, the gunner and No. 1 assist by alternately setting and releasing the right and left brakes, thus permitting the piece to be pivoted about the locked wheel. At the command HALT, they stop the piece, the gunner and No. 1 set the brakes, and all resume their posts (par. 19).

b. Caisson.—Executed as explained for the piece, except that No. 4 releases the caisson brake and No. 3, when the trail is raised, raises and secures the caisson prop. The gunner and No. 1 are at the rear of the caisson chest when moving forward and at the front of the caisson chest when moving backward, the gunner on the left. At the command HALT, No. 3 lowers the caisson prop and No. 4 sets the caisson brake. All take their posts (par. 19).

SECTION V

UNLIMBERING AND LIMBERING

■ 14. UNLIMBERING.—*a. Disposition of the carriages.*—(1) *Before unlimbering.*—The piece and its caisson are placed abreast of each other, 2 yards apart, poles pointing in the direction of movement. This formation of the carriages is called a double section. The interval of 2 yards should not be materially changed, otherwise the amount of movement of the carriages by hand is greatly increased. If it is intended to fire to the front, the caisson should be placed on the left of the piece before the command for unlimbering is given; if it is intended to fire to the rear, the caisson should be on the right of the piece; if to the flank, on either side of the piece. In emergencies the carriages may be unlimbered from any formation.

(2) *After unlimbering.*—(a) The adjacent wheels of the piece and the caisson are abreast of each other about 1 foot apart, trails of the piece and the caisson pointing to the rear, the piece on the right.

(b) In emergencies the caisson may be placed temporarily on the right of the piece. As this position is not favorable to

the service of ammunition, the caisson should be moved to the left of the piece as soon as practicable.

(c) At ceremonies and drills, limbers are posted 25 yards in rear of their carriages, moving to their post at a trot. In active service and in instruction simulating it, limbers are conducted by the first sergeant to a place previously designated by the battery commander, where they are disposed so as to take the best advantage of cover and concealment. If no cover and concealment are available, they are located in rear of either flank, faced toward the front, with wide intervals between them.

b. To unlimber.—(1) *General.*—In unlimbering, the piece establishes the position. When the carriages are 25 yards from the position, the gait is reduced to a walk; cannoneers other than horseholders dismount, turn their horses over to the horseholders, and double time to their posts (fig. 3). If the carriages, after unlimbering, have to be moved by hand, each carriage is moved as prescribed in paragraph 13, in the order designated by the chief of section. If the teams are not hitched, the carriages are unlimbered successively, the one which establishes the position being unlimbered first. Limbers are moved to their position by cannoneers designated by the chief of section.

(2) *To fire to the front.*—The carriages being in double section, the caisson on the left, the command is: **ACTION FRONT.** If marching, the carriages halt at the command or signal.

(a) *The piece.*—The gunner and No. 1 hasten to the trail handles; No. 2 grasps the right wheel and places himself so as to be ready to turn the wheel toward the muzzle; No. 5 grasps the left wheel and places himself so as to be ready to turn the wheel toward the trail. The gunner unlatches the pintle and assisted by No. 1 raises the trail from the pintle. The gunner then commands or signals **DRIVE ON.** The gunner and No. 1 carry the trail away from the caisson, and all the cannoneers working together turn the piece 180°. The gunner and No. 1 lower the trail to the ground, and all the cannoneers at the piece take their posts (pars. 18c and 19).

(b) *The caisson.*—Nos. 3 and 4 hasten to the trail handles; No. 4 unlatches the pintle; Nos. 3 and 4 raise the trail

from the pintle, and No. 4 commands or signals **DRIVE ON**. Nos. 3 and 4, assisted by the higher-numbered cannoneers at the wheels, then carry the trail away from the piece, turning the caisson 180°. No. 3, assisted by No. 4, lowers the caisson prop; No. 4 sets the caisson brake, and Nos. 3 and 4 take their posts. As soon as practicable, the caisson is placed beside the piece (*a* (2) above).

(c) *Limbers*.—At the command **DRIVE ON**, the limbers take their prescribed positions. To take post in rear of the carriages, the caisson limber executes a left-about, moves straight to the rear, executes another left-about, and halts so that the heads of the lead horses (or the end of the pole if teams are not hitched) will be 25 yards from the rear of the caisson. The piece limber follows the caisson limber, passes around its rear, and halts so as to be abreast of it and 2 yards to its right.

(3) *To fire to the rear*.—The carriages being in double section, caisson on the right, the command is: **ACTION REAR**. If marching, the carriages halt at the command or signal.

(a) *The piece*.—The gunner and No. 1 hasten to the trail handles of the piece; No. 2 grasps the right wheel and No. 5 grasps the left wheel of the piece and both stand ready to assist in such movements of the carriage as may be necessary. The gunner unlatches the pintle and assisted by No. 1 raises the trail from the pintle. The gunner then commands or signals **DRIVE ON**. The gunner and No. 1 lower the trail to the ground, and the cannoneers at the piece take their posts (pars. 18c and 19).

(b) *The caisson*.—Nos. 3 and 4 hasten to the trail handles; No. 4 unlatches the pintle; Nos. 3 and 4 raise the trail from the pintle, and No. 4 commands or signals **DRIVE ON**. No. 3, assisted by No. 4, lowers the caisson prop; No. 4 sets the brake, and Nos. 3 and 4 take their posts. As soon as practicable, the caisson is placed beside the piece (*a* (2) above). Higher-numbered cannoneers, when present, assist in the movement as directed by the chief of section.

(c) *Limbers*.—At the command or signal **DRIVE ON**, the limbers take their prescribed positions. To take post in rear of the carriages, the caisson limber inclines well to the right,

moves to the rear, executes a left-about, and halts so that the heads of the lead horses (or the end of the pole if teams are not hitched) will be 25 yards from the rear of the caisson. The piece limber follows the caisson limber, passes around its rear, and halts so as to be abreast of it and 2 yards to its right.

(4) *To fire to the flank.*—(a) The carriages being in double section, the caisson on either side of the piece, 2 yards from and abreast of it, the command is: **ACTION RIGHT (LEFT)**. The movement is executed according to the principles of **ACTION FRONT** and **ACTION REAR**, with the following modifications: After the carriages are unlimbered, the muzzle of the piece is turned in the direction of fire and the trail of the caisson in the opposite direction; the caisson is moved to its proper position beside the piece (a (2) above).

(b) At the command or signal **DRIVE ON**, the limbers take their prescribed positions. To take post in rear of the carriages, the limber away from the flank toward which fire is to be delivered moves out first, wheels away from the direction of fire, and after having gained sufficient distance to the rear executes an about, and halts so that the heads of the lead horses (or the end of the pole if teams are not hitched) will be 25 yards from the rear of its carriage. The other limber follows and takes post in a similar manner.

■ 15. **LIMBERING.**—*a. To limber front and rear.*—The carriages being in position and in march order (par. 20), the command is: **LIMBER FRONT AND REAR**.

(1) No. 4 releases the caisson brake and hastens to the caisson trail; Nos. 3 and 4 raise the trail and when the trail is raised No. 3 raises and secures the caisson prop. Nos. 3 and 4 working at the trail, all other cannoneers assisting, turn the caisson 180°, carrying the trail away from the piece, the gunner and even numbers working on the right and odd numbers on the left. The movement being completed, Nos. 3 and 4 lower the caisson prop; No. 4 sets the caisson brake, and the cannoneers take posts for limbering as follows: The gunner and No. 1 face to the rear at their posts; No. 2 places himself on the right of the gunner and faces to the rear; No. 5 places himself on the left of No. 1 and faces

to the rear. Nos. 3 and 4 place themselves with their backs toward the caisson chest close up against the chest, No. 4 on the right and No. 3 on the left of the trail. Higher-numbered cannoneers take post as directed by the chief of section.

(2) The limbers are brought up as described in Part Two, FM 6-5. As soon as the limber has halted in prolongation of the piece trail, the gunner and No. 1 spring to the trail handles and raise the trail. Nos. 2 and 5 hasten to the piece wheels and prepare to assist in any movement of the carriage that may be necessary. The gunner and No. 1 place the lunette over the pintle; the gunner then latches the pintle. The caisson is limbered simultaneously in the same manner; Nos. 3 and 4 handle the trail, No. 4 latching the pintle. Higher-numbered cannoneers assist by working at the wheels of the caisson in any movement of the carriage. As soon as the carriages are limbered, cannoneers take their posts at the carriages limbered (fig. 3).

b. To limber rear.—The carriages being in position and in march order (par. 20), the command is: **LIMBER REAR.**

(1) No. 4 releases the caisson brake; Nos. 3 and 4 raise and secure the caisson prop. All cannoneers working together run the caisson 15 yards straight to the rear of the line of spades. Nos. 3 and 4 lower the caisson prop, No. 4 sets the caisson brake, and all the cannoneers take posts for limbering (*a* (1) above).

(2) The limbers are brought up and the limbering is completed as prescribed in *a* (2) above.

SECTION VI

UNCOUPLING AND COUPLING

■ 16. **UNCOUPLING.**—*a. General.*—At drills, trucks are posted as directed by the battery commander. In active service and in instruction simulating it, the trucks are conducted by the first sergeant to a place previously designated by the battery commander, where they are disposed so as to take the best advantage of cover and concealment. If no cover and concealment are available, they are located in rear of

either flank, faced to the front, with wide intervals between them.

b. To fire to the front.—The command is: **ACTION FRONT**. If marching, the trucks halt at the command or signal. The cannoneers, if mounted, dismount after the trucks have halted.

(1) *The piece.*—The gunner and No. 1 hasten to the wheels nearest their respective posts. Nos. 2 and 5 hasten to the trail handles, No. 2 on the right. No. 2 unlatches the pintle and assisted by No. 5 raises the trail from the pintle; Nos. 2 and 5, assisted by No. 1 at the wheel, swing the piece 180° clockwise and lower the trail to the ground. Prior to the turn, the gunner sets the brake on the pivot wheel (the wheel adjacent to the gunner's post), and when the turn is completed No. 1 sets the other brake. Nos. 3 and 4 unload the ammunition, tools, and accessories from the truck and place them to the left of the piece as directed by the chief of section. When the trail has been lowered to the ground, the gunner and Nos. 1, 2, and 5 assist Nos. 3 and 4 in completing the unloading. When the unloading has been completed, the chief of section commands or signals **DRIVE ON**. The gunner and all cannoneers take their posts (par. 19).

(2) *The trucks.*—At the command **DRIVE ON**, the trucks move out and are conducted by the first sergeant to their previously designated position.

c. To fire to the rear.—The command is: **ACTION REAR**. The movement is executed according to the principles of **ACTION FRONT** except that the piece is not turned after uncoupling.

d. To fire to the flank.—The command is: **ACTION RIGHT (LEFT)**. The movement is executed according to the principles of **ACTION FRONT**, with the following modifications: After uncoupling, the trail is turned 90° away from the direction of fire, and the piece is run forward sufficiently to clear the track made by the truck. Articles unloaded from the truck are placed on the ground so as to clear the track made by the truck.

■ 17. **COUPLING.**—*a.* The pieces being in position and in march order, the command is: **COUPLE**. The trucks under

the command of the first sergeant approach the position from the right (left) flank. As each truck approaches its piece, it turns to the left (right) and halts in prolongation of the trail of the piece.

b. All cannoneers working together under the direction of the chief of section load the tools, accessories, and unexpended ammunition. Then Nos. 2 and 5 hasten to the trail handles. The gunner and No. 1 release the brakes. The truck upon signal from the chief of section is maneuvered backward until the pintle is almost over the lunette. Nos. 2 and 5 raise the trail and place the lunette over the pintle. No. 2 latches the pintle. All cannoneers take their posts (par. 8).

SECTION VII

PREPARATION FOR ACTION AND MARCH ORDER

■ 18. TO PREPARE FOR ACTION.—*a.* The carriages being in position unlimbered (uncoupled), the command is: **PREPARE FOR ACTION.** Duties of the individuals are as follows:

(1) *Chief of section.*—(*a.*) Supervises the work of the cannoneers.

(*b.*) Inspects the matériel, verifies the fact that the recoil mechanism contains the proper amount of oil (par. 47); and, when the operations have been completed, reports to the executive, "Sir, No. (so and so) in order," or reports any defects which the section cannot remedy without delay.

(2) *Gunner.*—(*a.*) Assisted by No. 1, dismounts the sight chest and places it to the left of the piece.

(*b.*) Assists No. 1 to unsnap the howitzer cover.

(*c.*) Removes the left trail pin.

(*d.*) Unstraps the front end of the aiming stake on the left trail.

(*e.*) Replaces the left trail pin after the left trail is spread.

(*f.*) Removes the panoramic sight, the range quadrant, and the elbow telescope from the sight chest; hands the range quadrant and elbow telescope to No. 1; seats the panoramic sight in its bracket.

(*g.*) Sets deflection zero and centers the bubbles.

(*h.*) Takes his post.

(3) *No. 1.*—(a) Assists the gunner to dismount the sight chest.

(b) Assisted by the gunner, unsnaps the howitzer cover and places the breech section to the right of the piece.

(c) Removes the right trail pin.

(d) Unstraps the front end of the aiming stake on the right trail.

(e) Elevates the piece on signal from No. 2.

(f) Releases the right wheel brake and when necessary assists No. 4 to raise the right wheel.

(g) Replaces the right trail pin after the right trail is spread.

(h) Receives the range quadrant and the elbow telescope from the gunner and seats it in its bracket; when ordered by the chief of section, rotates the elbow telescope to the firing position.

(i) Sets site 300, range 3,000, and centers the bubbles.

(j) Opens the breech; examines the breechblock, the chamber, and the bore, cleaning any parts requiring it; leaves the breech open.

(k) Takes his post.

(4) *No. 2.*—(a) Passes around the left of the piece, removes the muzzle section of the howitzer cover and tosses it to the right of the piece.

(b) Removes the muzzle cover and tosses it to the right of the piece.

(c) Releases the cradle lock, calls to No. 1 to elevate the piece, and lowers the firing base to the firing position. (For pieces equipped with a separate traveling lock, No. 2 first releases and lowers the firing base; he then unlatches the cradle lock, calls to No. 1 to elevate the piece, and lowers the traveling lock.)

(d) Replaces the cradle lock.

(e) Releases the left wheel brake and when necessary assists No. 3 to raise the left wheel.

(f) Takes his post.

(5) *No. 3.*—(a) Secures the left trail handspike and places it in the left wheel socket; unlatches left wheel.

(b) Assisted when necessary by No. 2, raises the left wheel, latches the left wheel latch, and sets the wheel brake.

(c) Places the left trail handspike in the left trail socket and spreads the left trail.

(d) Places the fuze setter in position, and sets corrector 30, range 3,000.

(e) Puts a round of shrapnel in the fuze setter.

(f) Assisted by Nos. 4 and 5, arranges ammunition and tools in an orderly and convenient manner.

(g) Takes his post.

(6) No. 4.—(a) Secures the right trail handspike and places it in the right wheel socket; unlatches the right wheel.

(b) Assisted when necessary by No. 1, raises the right wheel, latches the right wheel latch, and sets the wheel brake.

(c) Places the right trail handspike in the right trail socket and spreads the right trail.

(d) Assists No. 3 to arrange ammunition and tools in an orderly and convenient manner.

(e) Takes his post.

(7) No. 5.—(a) As soon as the sight chest has been dismounted, unlocks the trails and spreads them parallel.

(b) Folds the howitzer cover and places it 1 yard to the right of the right piece wheel.

(c) Places the muzzle cover on the howitzer cover.

(d) Removes the sponge-and-rammer staff from the traveling position, assembles it, and places it on the howitzer cover.

(e) Removes the aiming stakes from the trails, assembles them, and places them beside the sponge-and-rammer staff, or sets them out when so directed by the chief of section.

(f) Obtains the lanyard and attaches it to the trigger.

(g) Assists No. 3 to arrange ammunition.

(h) Takes his post.

b. The limbered (coupled) carriages may be partially prepared for action before reaching the firing position. The duties of the cannoneers are the same as when the carriages are unlimbered (uncoupled), but only such operations as are practicable are carried out before the carriages are unlimbered (uncoupled). Immediately after establishing the carriages in position, preparation for action is completed without command, and the cannoneers take their posts for firing the piece.

c. If PREPARE FOR ACTION has not been ordered, the carriages are established in the firing position, the caution habitually is given by the chief of section as soon as the carriages have been unlimbered (uncoupled). In the event not desired, the caution "Do not prepare for action" may be given.

■ 19. POSTS OF THE CANNONEERS, CARRIAGES UNLIMBERED (UNCOUPLED).—*a.* The carriages having been unlimbered (uncoupled), posts are taken as follows:

(1) *Chief of section.*—The chief of section goes to the rear of the caisson to control the service of the piece, hear commands, and perform his duties effectively. A convenient position is from the end of the trail on the side opposite the breech.

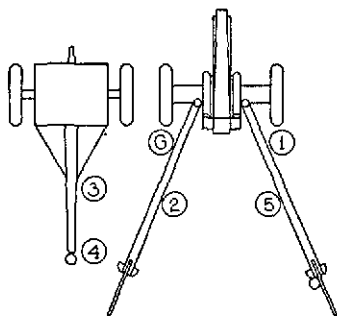

FIGURE 5.—Posts of the cannons, carriages unlimbered (uncoupled).

(2) *Gunner.*—On the left of the breech, abreast of it, outside the trail.

(3) *No. 1.*—On the right of the breech, abreast of it, outside the trail.

(4) *No. 2.*—Two feet in rear of the gunner, covering the caisson trail.

(5) *No. 3, horse units.*—Two feet in rear of the chest, on the right of the caisson trail.

(6) *No. 3, truck-drawn units.*—Two feet to the rear of the caisson, opposite the rear of the left piece wheel.

(7) *No. 4.*—Two feet in rear of No. 3, covering the caisson trail.

(8) *No. 5.*—Two feet in rear of No. 1, covering the caisson trail.

b. At drill all stand at attention at their posts, facing the front (fig. 5). In firing and in combat, minor modifications of these posts are required for the more efficient performance of the duties in the service of the piece and to secure the protection afforded by the matériel. Higher-numbered cannoneers, if present, take posts as prescribed by the chief of section.

c. In order to exercise the cannoneers in all the duties connected with the service of the piece and to lend variety to the drill, the posts of individual cannoneers should be changed frequently.

■ 20. MARCH ORDER.—*a. Duties of individuals.*—The carriages being unlimbered (uncoupled) and prepared for action, to resume the order for marching, the command is: MARCH ORDER. Duties are as follows:

(1) *Chief of section.*—(a) Supervises the work of the cannoneers.

(b) Inspects the matériel; *makes sure that the piece is not left loaded*; and, when the operations have been completed, reports to the executive, "Sir, No. (so and so) in order," or reports any defects which the section cannot remedy without delay.

(2) *Gunner.*—(a) Removes the left trail pin.

(b) Traverses the piece to the center.

(c) Closes the covers on the levels and sets the tilting head and deflection at zero; removes the sight from its bracket.

(d) Receives the range quadrant and elbow telescope from No. 1 and returns it and the panoramic sight to the sight chest.

(e) Traverses the piece as called for by No. 2.

(f) Replaces the left trail pin.

(g) Straps the front end of the aiming stake on the left trall.

(h) Assisted by Nos. 1 and 2, replaces the howitzer cover.

(i) Assisted by No. 1, mounts the sight chest.

(3) *No. 1.*—(a) Removes the right trail pin.

(b) Closes the breech.

(c) Hands the muzzle cover to No. 2.

(d) Closes the covers on the level; sets site 300, range 3,000; removes the range quadrant and elbow telescope from its socket and hands it to the gunner.

(e) When necessary, assists No. 4 to rotate the right wheel to the traveling position.

(f) Elevates or depresses the piece as called for by No. 2.

(g) Replaces the right trail pin.

(h) Straps the front end of the aiming stake on the right trail.

(i) Assists the gunner to mount the sight chest.

(j) Assists the gunner and No. 2 to replace the howitzer cover.

(k) Takes his post.

(4) No. 2.—(a) Passes around the left of the piece, receives the muzzle cover from No. 1, and places it on the muzzle.

(b) When necessary, assists No. 3 to rotate the left wheel to the traveling position.

(c) Releases the firing base lock, brings the firing base up, calls to the gunner to traverse and No. 1 to elevate or depress as necessary, and locks the cradle lock. (For pieces equipped with a separate traveling lock, No. 2 raises the traveling lock, calls to the gunner to traverse and No. 1 to elevate or depress as necessary, and locks the cradle lock; he then releases the firing base lock and secures it in the traveling position.)

(d) Assists the gunner and No. 1 to replace the howitzer cover.

(e) Takes his post.

(5) No. 3.—(a) Closes the left trail to the parallel position.

(b) Removes the left trail handspike and places it in the left wheel socket, releases the left wheel brake, and unlatches the wheel.

(c) Assisted when necessary by No. 2, rotates the left wheel to the traveling position and latches the wheel latch; sets the left wheel brake.

(d) Places the left trail handspike in the traveling position.

(e) Sees that all fuzes are set at *safe* or *quick*.

(f) Sets the fuze setter at corrector 30, range 3,000.

(g) Replaces the fuze setter and tools in the section chest.

(h) Assisted by Nos. 4 and 5, loads ammunition into the caisson or prepares it for loading into the truck.

(i) Takes his post.

(6) *No. 4.*—(a) Closes the right trail to the parallel position.

(b) Removes the right trail handspike and places it in the right wheel socket, releases the right wheel brake, and unlatches the wheel.

(c) Assisted when necessary by No. 1, rotates the right wheel to the traveling position and latches the wheel latch; sets the right wheel brake.

(d) Places the right trail handspike in the traveling position.

(e) Assists No. 3 to load ammunition into the caisson or to prepare it for loading into the truck.

(f) Takes his post.

(7) *No. 5.*—(a) Removes the lanyard and returns it to the section chest.

(b) Secures the aiming stakes, disassembles them, places them in the traveling position, and fastens the rear straps.

(c) Disassembles the sponge-and-rammer staff and fastens it in the traveling position.

(d) Locks the trails in the traveling position.

(e) Assists No. 3 to load ammunition into the caisson or to prepare it for loading into the truck.

(f) Takes his post.

b. To resume fire in another position.—(1) If it is intended to resume firing shortly, but in another position, so that the limbering (coupling) of the pieces is necessitated, the command MARCH ORDER is not given. In this case, at the command for limbering (coupling), only such of the operations incident to march order are performed as are necessary for the movement of the piece and caisson and for the care and security of the equipment.

(2) If the command MARCH ORDER is given while the pieces are limbered (coupled), the operations pertaining to march order are completed as described above.

SECTION VIII

DUTIES IN FIRING

■ 21. GENERAL.—*a.* In general, the duties in firing are as follows:

(1) The chief of section is responsible that all duties are properly performed, all commands executed, and all safety precautions observed.

(2) The gunner sets the announced deflection, lays for direction, and refers the piece.

(3) No. 1 sets the announced site and range (elevation) and lays for elevation.

(4) No. 2 loads the piece and works with No. 5 in shifting the trails.

(5) No. 3 operates the fuze setter or sets fuzes as ordered; he passes projectiles to No. 2 when firing shell.

(6) No. 4 prepares ammunition; in time fire, he keeps rounds in the fuze setter, sets the fuze, and passes rounds to No. 2 for loading.

(7) No. 5 opens and closes the breech, fires the piece, and works with No. 2 in shifting the trails.

b. The duties of the gunner and Nos. 1, 2, and 5 are mutually dependent. The same is true of Nos. 3 and 4.

c. When firing by individual sections at moving targets with direct laying, the elbow telescope ordinarily is used, and the duties of certain members of the howitzer squad differ slightly from those given in this section. For duties in this type of fire, see paragraph 30.

■ 22. CHIEF OF SECTION.—*a. Enumeration of duties.*—(1) Assisted by No. 1, to lay for elevation when the gunner's quadrant is used.

(2) To measure the elevation.

(3) (*a*) To measure the minimum quadrant elevation.

(*b*) To measure the minimum range.

(4) To indicate to the gunner the aiming point, the referring point, or the target.

(5) To follow fire commands.

(6) To indicate when the piece is ready to fire.

(7) To give the command to fire.

(8) To report errors and other unusual incidents of fire to the executive.

(9) To conduct prearranged fire schedules.

(10) To record basic data.

(11) To observe and check frequently the functioning of the matériel.

(12) To assign duties when firing with reduced personnel.

b. Detailed description of certain duties.—(1) *To lay for elevation when the gunner's quadrant is used.*—(a) The chief of section is first taught to read settings on the gunner's quadrant and then to set the elevations announced. To set an elevation on the gunner's quadrant, for example 361.8 mils, the chief of section sets the upper edge of the head of index arm opposite the 360 mark of the graduated arc on the quadrant frame and slides the slide level along the index arm until its index is opposite the 1.8 mark of the scale on the index arm. Care must be taken in setting the slide to use the scale on the index arm which is on the same side of the quadrant as the graduated arc on the frame which was used in setting the index arm at 360 mils. After the slide has been set at the proper index, the clamp is tightened just sufficiently to hold the slide in place.

(b) The command QUADRANT (SO MUCH) indicates that the gunner's quadrant is to be used.

(c) The announced elevation having been set on the gunner's quadrant, the piece loaded, and the breechblock closed, the chief of section places the quadrant on the quadrant seat with the words "line of fire" at the bottom and the arrow pointing toward the muzzle. The chief of section must be sure to use the arrow which appears on the same side of the quadrant as the scale which he is using. He stands squarely opposite the side of the quadrant and holds it firmly on the quadrant seat, parallel to the axis of the bore. It is important that he take the same position and hold the quadrant in the same manner for each subsequent setting, so that the quadrant bubble will in each case be viewed from the same angle.

(d) The chief of section then causes No. 1 to elevate or depress the piece until the bubble is centered, *being careful*

that the last motion of the bubble is from front to rear. The chief of section warns No. 1 when the bubble is approaching the center, in order that the final centering may be performed accurately.

(2) *To measure the elevation.*—At the command MEASURE THE ELEVATION, the piece having been laid, the chief of section sets the slide level of the index arm of the gunner's quadrant at zero and places the quadrant on the quadrant seat as in laying for elevation ((1) above). He then moves the index arm until the bubble passes to the end of the vial away from the hinge of the index arm. He then slowly lowers the index arm until the bubble just passes to the end of the vial toward the hinge. He then allows the index arm to engage the arc and slides the level along the index arm until the bubble is accurately centered. He then removes the quadrant and reads and announces the elevation thus set; for example, "Elevation, No. (so and so), (so much)."

(3) *To measure the minimum elevation or minimum range.*

(a) 1. *Minimum elevation with the gunner's quadrant.*—

The command is: MEASURE THE MINIMUM ELEVATION. The chief of section, sighting along the lowest element of the bore, causes No. 1 to operate the elevating mechanism until the line of sight just clears the crest. He then measures the quadrant elevation as described in (2) above and reports the angle read from the gunner's quadrant to the executive, thus, "Minimum elevation, No. (so and so), (so much)."

2. *Minimum elevation with the elevation scale.*—The command is: MEASURE THE MINIMUM ELEVATION, SITE (SO MUCH). The chief of section causes No. 1 to set the announced site and to lay as described above. No. 1 then centers the elevation bubble with the range-and-elevation-scale knob and reads the elevation. The chief of section then reports the minimum elevation to the executive, thus, "Minimum elevation, No. (so and so), (so much), site (so much)."

3. *Minimum range.*—The command is: **MEASURE THE MINIMUM RANGE, SITE (SO MUCH)**. The chief of section causes the piece to be laid and the elevation bubble to be centered with the range-and-elevation-scale knob as described above. No. 1 then reads the range setting, and the chief of section reports this range as the minimum range to the executive, thus, "Minimum range, No. (so and so), (so much), site (so much)."

(b) When the executive announces the corrected minimum elevation, or the corrected minimum elevation (or range) and site, the chief of section records it in a notebook and causes the gunner to chalk it on a convenient place on the carriage.

(4) *To indicate to the gunner the aiming point, the referring point, or the target.*—Whenever an aiming point, a referring point, or a target has been designated by the executive, the chief of section will make sure that he has properly identified the point in question. He will then indicate it to the gunner. If there is any possibility of misunderstanding, the chief of section will turn the sight until the horizontal and vertical hairs are on the point designated.

(5) *To follow fire commands.*—The chief of section will follow the fire commands mentally. He will not repeat the commands, but will be prepared to give any element of the last command to any cannoneer who has failed to hear it.

(6) *To indicate when the piece is ready to fire.*—When arm signals between the chief of section and the executive can be observed, the chief of section will extend his right arm vertically as soon as the gunner has called "Ready," as a signal to indicate that the piece is ready to fire. When arm signals cannot be observed, the chief of section reports orally to the executive, "No. (so and so), ready."

(7) *To give the command to fire.*—When No. 5 can see arm signals made by the chief of section, the chief of section will give the command to fire by dropping his right arm sharply to his side. When arm signals cannot be used, the command NO. (SO AND SO) FIRE will be given orally. *The chief*

of section will not give the signal or command to fire until all the cannoneers are in safe positions.

(8) *To report errors and other unusual incidents of fire to the executive.*—If for any reason the piece cannot be fired, the chief of section will report promptly to the executive that fact and the reason therefor; for example, "No. (so and so) out, misfire." Whenever it is discovered that the piece has been fired with an error in laying, the chief of section will report that fact at once; for example, "No. (so and so) fired with incorrect deflection." Whenever the gunner reports that the aiming stakes are out of alinement with the sight, the chief of section will report that fact and request instructions (par. 33). Likewise, other unusual incidents that affect the service of the piece are promptly reported by the chief of section.

(9) *To conduct prearranged fire schedules.*—Whenever the execution of prearranged fires is ordered, the chief of section will conduct the fire of his section in strict conformity to the schedules prescribed.

(10) *To record basic data.*—Data of a semipermanent nature will be recorded in a notebook by the chief of section. This includes such data as minimum elevation, base deflections, including aiming points used; prearranged fires when prepared schedules are not furnished; safety limits in elevation and deflection; number of rounds fired, with the date and hour; and calibration corrections when appropriate.

(11) *To observe and check the functioning of the matériel.*—The functioning of all parts of the matériel will be observed closely during firing. Before the piece is fired, the chief of section verifies the fact that the recoil mechanism contains the proper amount of oil and thereafter carefully observes the functioning of the recoil system. Any evidence of trouble (par. 47) is reported promptly to the executive.

(12) *To assign duties when firing with reduced personnel.*—Whenever the personnel of the section serving the piece is temporarily reduced in numbers below that indicated in this manual, the chief of section will make such redistribution of duties as will best facilitate the service of the piece.

23. GUNNER.—*a. Enumeration of duties.*—(1) (a) To center the bubbles on the sight mount.

(b) To set or change the deflection.

(c) To apply the deflection difference.

(d) To lay for direction.

(e) To call "Ready."

(f) To refer the piece.

(g) To record base deflection.

(h) To measure a deflection.

(2) For indirect laying or direct laying, the gunner performs duties prescribed in (1) (a), (b), (c), (d), and (e) above.

(3) When directed, the gunner performs the duties prescribed in (1) (f), (g), and (h) above.

b. Detailed description of certain duties.—(1) *To set or change the deflection.*—(a) *To set the deflection.*—The gunner is first taught to read deflections set on the sight and then to set the deflections announced. At the command, for example, DEFLECTION 1,885, the gunner pushes the throw-out lever with his right hand and with his left hand turns the rotating head until the hundreds' graduation (18 in this case) is opposite the azimuth-circle index. He then releases the throw-out lever and grasping the azimuth-worm knob with his left hand with the thumb on top turns the azimuth-worm knob toward himself until the micrometer index is opposite the graduation 85 of the azimuth micrometer. The line of sight will then make a horizontal angle of 1,885 mils with the axis of the bore.

(b) *To change the deflection.*—The gunner should be trained always to grasp the azimuth-worm knob with his left thumb on top, as the command for changing the deflection then will indicate the direction in which he should move his thumb in turning the azimuth-worm knob. He also should be taught that turning the azimuth-worm knob toward the muzzle (away from him) decreases the deflection set on the sight and results in moving the muzzle to the right when the piece is laid with the new deflection. Similarly, turning the azimuth-worm knob toward the breech (toward him-

self) increases the deflection and results in moving the muzzle to the left when the piece is laid. The deflection having been set at 1,885 mils, if a subsequent command be, for example, RIGHT 65, the gunner turns the azimuth-worm knob by moving his thumb away from himself until the micrometer index has moved 65 mils on the graduations of the azimuth micrometer. Since turning the azimuth-worm knob away from himself decreases the deflection, the resulting deflection will be 1,820 mils. Should the command be LEFT (SO MUCH), the deflection setting is changed in a similar manner, except that the gunner moves his thumb toward himself.

(2) *To apply the deflection difference.*—(a) The command is: ON NO. (SO AND SO) OPEN (CLOSE) (SO MUCH). The gunner of the piece indicated in the command does not change the deflection set on his sight. Each of the other gunners changes his sight setting by the number of mils specified in the command if his piece is next in line to the piece indicated; by twice this number of mils if his piece is second in line from the piece indicated; by three times this number of mils if his piece is third in line from the piece indicated.

(b) If the command is, for example, ON NO. 1 OPEN 5, the gunner on No. 1 makes no change; the gunner on No. 2 turns the azimuth-worm knob by moving his thumb toward himself and sets off 5 mils once; the gunner on No. 3 turns the azimuth-worm knob in a similar manner, except that he sets off 5 mils twice, a total of 10 mils; the gunner on No. 4 turns his azimuth-worm knob in a similar manner, except that he sets off 5 mils three times, a total of 15 mils.

(c) Should the command be, for example, ON NO. 3 CLOSE 10, the gunner on No. 1 turns the azimuth-worm knob by moving his thumb toward himself and sets off 10 mils twice, or a total of 20 mils; the gunner on No. 2 turns his azimuth-worm knob in a similar manner, except that he sets off 10 mils once; the gunner on No. 3 makes no change; the gunner on No. 4 turns his azimuth-worm knob by moving his thumb away from himself and sets off 10 mils once.

(d) In turning the azimuth-worm knob the gunner must remember that the movement of the muzzle will follow the

movement of his thumb. For example, grasping the azimuth-worm knob with his left thumb on top, to move the muzzle to the right, his thumb moves toward the muzzle, and he can be taught to visualize the movement as pushing the muzzle away from him (to the right); to move the muzzle to the left, his thumb moves toward the breech, and he can be taught to visualize this movement as pulling the muzzle toward him (to the left).

(e) In training gunners to apply the deflection difference, it will be found advantageous to teach them to use the sight as a mechanical adding machine. For example, if the command is ON NO. 1 OPEN 8, the gunner on No. 4 first sets off 8 mils, then after an imperceptible pause another 8 mils, and so on until he has set off 8 mils three times. This method requires no mental arithmetic.

(f) When a deflection change and a deflection difference are announced at the same time, for example: RIGHT 30, on NO. 1 CLOSE 5, both of which affect the gunner's piece, he will first set off the deflection change and then apply the deflection difference.

(3) *To lay for direction.*—(a) *Direct laying on a stationary target.*—The deflection having been set, the gunner traverses the piece by turning the traversing handwheel until the vertical hair of the sight is on his part of the target. If the amount of movement necessary to lay on the target is greater than can be obtained by traversing, the trails must be shifted. To shift the trails, the gunner commands or signals MUZZLE RIGHT (LEFT). Nos. 2 and 5 working at the left and right trail handspikes, respectively, shift the trails so that the muzzle moves in the indicated direction, until commanded to stop by the gunner. The gunner then completes the laying by bringing the vertical hair of the sight on the target.

(b) *Indirect laying.*—The deflection having been set, the gunner brings the vertical hair of the sight on the aiming point by traversing the piece. If the amount of movement is greater than can be obtained by traversing, the trails are shifted as explained in (a) above.

(c) *Procedure to insure accuracy.*—To take up lost motion, the final movement of the traversing handwheel should be such as to cause the vertical hair of the sight to approach the

aiming point from the left. The gunner should habitually lay with the vertical hair of the sight on exactly the same portion of the aiming point or target for each round.

(4) *To call "Ready."*—The piece having been laid for direction, the bubbles centered, and No. 1 having called "Set," the gunner verifies the laying, moves his head clear of the sight, and calls "Ready" to indicate that his piece is ready to be fired.

(5) *To refer the piece.*—The piece having been laid for direction, to refer the piece, the command is: 1. AIMING POINT (SO AND SO), 2. REFER. Without disturbing the laying of the piece, the gunner brings the vertical hair of the sight on the new aiming point (referring point). He then reads and announces the deflection thus set and records the deflection and the referring point on a convenient part of the carriage. Two referring points usually are used, one for day and another for night. A referring point should be at least 50 yards from the sight, preferably to the rear. Frequently it will be necessary to use the aiming stakes as referring points, particularly for night use.

(6) *To record base deflection.*—At the command RECORD BASE DEFLECTION, the gunner records the deflection set on the sight upon some convenient part of the carriage or upon a data board (par. 41).

(7) *To measure a deflection.*—The command is: 1. AIMING POINT (SO AND SO), 2. MEASURE THE DEFLECTION. The piece having been established in direction, the gunner turns the sight until the vertical hair is on the aiming point. He then reads and announces the deflection.

■ 24. No. 1.—*a. Enumeration of duties.*—(1) (a) To set the angle of site.

(b) To set the range or elevation.

(c) To lay for range (elevation).

(d) To call "Set."

(2) For indirect laying without the gunner's quadrant or for direct laying (except when using the elbow telescope as prescribed in par. 30), No. 1 performs the duties prescribed in (1) (a), (b), (c), and (d) above.

(3) For indirect laying with the gunner's quadrant, No. 1 performs the duties prescribed in (1) (c) and (d).

b. Detailed description of certain duties.—(1) *To set the angle of site.*—No. 1 is first taught to read angle-of-site settings, and then to set announced angles of site. To set an angle of site, No. 1 turns the angle-of-site knob until the number of hundreds announced is opposite the index of the angle-of-site scale and the tens and units opposite the index of the micrometer. In setting the angle of site, No. 1 must look squarely at the micrometer index.

(2) *To set the range or elevation.*—(a) *Range.*—No. 1 is first taught to read range settings on the graduated range scale and then to set ranges. To set a range, No. 1 turns the range drum until the pointer is opposite the announced range, making sure that the last movement is in the direction of increasing range.

(b) *Elevation.*—The elevation may be set on the elevation scale. No. 1 is first taught to read elevations on the elevation scale and then to set announced elevations. Elevation is indicated by a scale graduated in hundreds of mils from zero to 800 and a micrometer scale graduated from zero to 100. To set an elevation, No. 1 turns the range drum until the announced elevation is set on the elevation and micrometer scales, making sure that the last movement is in the direction of increasing elevation.

(3) *To lay for range (elevation).*—The angle of site and range (elevation) having been set, No. 1 turns the elevation handwheel until the bubble of the angle-of-site level is centered, making sure that the last movement of the elevating handwheel is in the direction of decreasing range (elevation). In centering the bubble, No. 1 must be careful to look squarely at it.

(4) *To call "Set."*—When No. 1 has completed his duties in laying the piece, and the breech has been closed, he calls "Set."

■ 25. No. 2.—*a. Enumeration of duties.*—(1) To load the piece.

(2) When necessary, to man the left trail.

(3) In volley fire, to call out the number of the round.

b. Detailed description of certain duties.—(1) *To load the piece.*—No. 2 receives the round from No. 3 (in shrapnel fire

from No. 4), grasping it with his right hand at the base of the case and his left hand in rear of the ogive. He inserts the round in the chamber, removes his left hand, pushes the round into the chamber with his right hand, and when he feels the round strike the extractor removes his right hand. At high elevations it may be necessary for No. 2 to keep his closed fist against the base of the cartridge case until the round is firmly seated against the extractor and the closing motion of the breechblock has been started. *No. 2 will be particularly careful to avoid striking the fuze against any portion of the matériel. To prevent premature bursts caused by projectiles being struck on the fuze by the piece in recoil, a round to be loaded will be held well out of the path of recoil of the howitzer until the latter is again in battery.* (AR 750-10.)

(2) *When necessary, to man the left trail.*—See paragraph 23b (3).

(3) *To call out the number of the round.*—To insure that the correct number of rounds is fired in volley fire, No. 2 calls out the range and the number of the round as he loads the piece; and as he loads the last round adds "Last round." For example, when two rounds are to be fired at 2,800, he calls out, "2,800 one; 2,800 two, last round." He should not speak louder than is necessary to insure his being heard by the members of his own gun squad.

■ 26. No. 3.—*a. Enumeration of duties.*—(1) To set the fuze setter.

(2) To set fuzes when using the hand fuze setter or when shell is being fired.

(3) To pass rounds to No. 2 when shell is being fired.

b. Detailed description of certain duties.—(1) *To set the fuze setter.*—(a) The series of fire commands for initially opening fire with time-fuzed projectiles will contain the data to be set on the fuze setter. These commands are, for example, CORRECTOR 28, 3,600. For subsequent rounds, the corrector setting is increased (decreased) at the command UP (DOWN) (SO MUCH).

(b) No. 3 is first taught to read data set on the fuze setter and then to set data announced. To set data on the bracket fuze setter, No. 3 turns the corrector-worm knob with his

right hand until the movable index is opposite the graduation on the corrector scale, corresponding to the corrector announced. He then turns the range-worm crank until the graduation on the range scale, corresponding to the range announced, is opposite the fixed index.

(c) To set data on the hand fuze setter, No. 3 turns the corrector-worm knob until the graduated line on the corrector scale, corresponding to the corrector announced, is in coincidence with the index engraved on the rim of the case. He then turns the knob on the range-scale worm until the graduation on the range scale, corresponding to the range announced, is in coincidence with the index on the index bar.

(d) If the range to be set on the fuze setter differs from that to be set on the piece, the command FUZE RANGE (SO MUCH) will be given. In this case No. 3 sets the fuze range on the fuze setter, disregarding the range announced for the piece.

(e) If the command PERCUSSION is given, the fuze setter is not used. However, No. 3 keeps the range scale of the fuze setter set according to the ranges announced. He is thus ready to pass to time fire as soon as a corrector is announced.

(f) To insure accuracy in setting the scales of the fuze setter, it is necessary that No. 3 look squarely at the scales and their indexes. To take up lost motion, the final movement of the scales should always be in a counterclockwise direction.

(g) The fuze data having been set on the fuze setter, No. 3 calls "Cut" as a signal to No. 4 to set the fuze.

(2) *To set fuzes.*—(a) *Time fuzes.*—No. 3 sets time fuzes only when the hand fuze setter is used. The fuze data having been set on the fuze setter as indicated above, to set the fuze, the projectile being held by No. 4, No. 3 places the fuze setter over the fuze. The fuze setter is then turned in the direction indicated by the arrow on the fuze-setter case until the slot in the range-ring carrier engages the pin on the graduated time-train ring of the fuze. The guide plate and the range-ring carrier will then bear firmly on the fuze. No. 3 continues to turn the fuze setter in the direction indicated until the stop pin attached to the corrector-scale support engages with the fixed stop pin on the fuze and prevents further motion. When

the fuze has been properly set, the pointer which is attached to the top of the corrector scale will register with the graduated line on the closing cap of the fuze.

(b) *M-39 fuzes*.—No. 3 assisted by No. 4 removes adhesive tape and shipping caps, and No. 3 inspects the setting of each fuze, which should be *quick*. This is indicated by the head of the striker extension being at the "in" position. To set the fuze for *delay*, No. 3 grasps the upper end of the striker extension and places it in the "out" position by turning it in a clockwise direction until further rotation is impossible. Turning the striker extension in a counterclockwise direction until continuous clicking is heard sets the fuze at *quick*.

(c) *M-48 fuzes*.—No. 3 inspects the setting of each fuze, which should be *quick*. This is indicated by the screw driver slot in the fuze being turned toward *SQ*. To set the fuze for *delay*, No. 3 turns the screw driver slot until it points toward *delay*.

(3) *To pass rounds to No. 2 in shell fire*.—No. 3 after setting the fuze passes the round to No. 2 in the most expeditious manner, and in such a way that No. 2 is enabled to grasp the base of the cartridge case with his right hand.

■ 27. No. 4.—*a. Enumeration of duties*.—(1) To arrange ammunition and to clean and prepare it for firing.

(2) To set the fuze when the bracket fuze setter is used.

(3) To hold the round while No. 3 sets the fuze, when the hand fuze setter is used.

(4) To pass the round to No. 2 in time fire.

(5) To prepare charges in shell fire.

b. Detailed description of certain duties.—(1) *To arrange ammunition and to clean and prepare it for firing*.—No. 4, when time permits, arranges the rounds so that they are within easy reach. He inspects each projectile to see that it is free from sand and dirt and that the rotating band is not burred. Any foreign matter will be removed by wiping with a piece of waste. Projectiles having burred rotating bands should be placed aside temporarily until the burs can be removed with a file.

(2) *To set the fuze when the bracket fuze setter is used*.—When the command CORRECTOR (SO MUCH) is given, No. 4 pro-

cures a round of shrapnel, removes the waterproof cap of the fuze, and inserts the point of the projectile in the bracket fuze setter, taking care that the lug nearest the point of the fuze engages in the groove in the fuze setter. When No. 3 has called "Cut," No. 4 turns the projectile with a steady and uniform motion in a clockwise direction until further movement is stopped. In turning the projectile, No. 4 stands to the rear of the fuze setter, facing to the right front. His left hand, back down, grasps the round at or near the forward end of the cartridge case. The palm of the right hand is placed on the base of the cartridge case, the fingers grasping the edge of the base. While turning the projectile, No. 4 takes care to hold it firmly against the guide and to keep the fuze well engaged by a steady pressure on the base of the cartridge case with his right hand. No. 4 then removes the round by lifting it directly out of the fuze setter, taking care not to strike the lugs of the fuze against any part of the fuze setter. The time of burning may be read from the graduated ring of the fuze. When directed by the chief of section, No. 4 will read and announce the time of burning after setting the fuze. A time fuze which has been set for any desired time of burning can be reset to *S* (Safe) by setting the fuze-setter range ring to *S*, the corrector to normal (30), and resetting the fuze. The fuze should be inspected to see that the *S* on the graduated time ring of the fuze is in line with the marks on the upper time-train ring and on the body of the fuze. Fuzes set but not fired will be reset to *S* (Safe), inspected, and returned to the chest or other container by No. 4. If the command PERCUSSION is given, No. 4, after removing the waterproof cap, passes the round directly to No. 2 for loading.

(3) *To hold the round while No. 3 sets the fuze, when the hand fuze setter is used.*—No. 4 holds the round while No. 3 sets the fuze. No. 4 procures the round, removes the waterproof cap, faces to the right, and partially kneels on the right knee. He places the base of the cartridge case on his right thigh just above the knee. He grasps the round with both hands, the right arm resting on his right thigh, the left arm braced against his left thigh. The round is held

firmly, pointing upward in the general direction of No. 3's head, while No. 3 sets the fuze.

(4) *To pass the round to No. 2 in time fire.*—No. 4 passes the round to No. 2 in the most expeditious manner and in such a way that No. 2 is enabled to grasp the base of the cartridge case with his right hand.

(5) *To prepare charges in shell fire.*—The propelling charge in the cartridge case consists of four sections, as follows: The bottom one, charge I; the bottom two, charge II; the bottom three, charge III; and all four sections, charge IV. At the command for the charge to be used, No. 4 removes the projectile from the cartridge case (except in case of charge IV), and if the command, for example, is CHARGE III, removes the top section, thus leaving three sections in the cartridge case. He then replaces the cartridge case on the projectile and passes the round to No. 3. Unused powder sections are placed at a convenient and safe location, and at a convenient time disposed of as the executive may direct.

■ 28. No. 5.—*a. Enumeration of duties.*—(1) To open and close the breech.

(2) To fire the piece.

(3) When necessary, to man the right trail.

(4) To keep empty cartridge cases out of the way.

(5) To use the rammer.

b. Detailed description of certain duties.—(1) *To open and close the breech.*—(a) *To open the breech.*—No. 5 grasps the operating handle with his right hand and compresses the lever latch. He rotates the lever to the right, sliding the breechblock to the right. *As soon as the breech is open, No. 5 looks through the breech to see that it is clear.*

(b) *To close the breech.*—No. 5 grasps the operating lever with his right hand and rotates the lever to the left, sliding the breechblock to the left.

(c) *Opening and closing the breech.*—When No. 5 understands the functioning of the breech mechanism, Nos. 5 and 2 are instructed in loading and unloading the piece. The breech being open, No. 5 rests his right hand lightly on the operating lever ready to close the breech. As the round is

inserted and pushed home by No. 2, No. 5 will start the closing motion of the block as soon as he feels the jar of the round striking the extractor. No. 5 must be careful not to grasp the operating lever firmly as the round is pushed home, since to do so may cause the extractor to strip the rim on the cartridge case and cause a jam. The drill projectiles used for this instruction must be in good condition. To avoid damaging the projectiles when they are ejected, a mat or similar cushion should be placed at the point where they fall. If full-weight drill projectiles are used, No. 2, standing at the breech, receives the ejected round with both hands.

(2) *To fire piece.*—At the chief of section's command NO. (SO AND SO) FIRE, No. 5 with his left hand draws the lanyard smartly to the rear so as to trip the trigger arm. If the chief of section gives the command STAND CLEAR, No. 5 steps outside the right wheel and fires the piece by leaning over so as to reach the lanyard. The chief of section may caution "With the long lanyard." In this case, No. 5 attaches the lanyard guide pulley to the handle of one of the trails or to a stake driven at a convenient position between the trails, attaches the loop of the lanyard to the trigger knob, steps clear, and fires as previously described. No. 5 detaches the long lanyard immediately after each round is fired. *In case of a misfire, the instructions contained in paragraph 39 will be followed.*

(3) *When necessary, to man the right trail.*—See paragraph 23b (3).

(4) *To keep empty cartridge cases out of the way.*—No. 5 throws the empty cartridge cases well to the rear of the left trail of the piece.

(5) *To use the rammer.*—*The sponge and rammer will be handled by No. 5 only.* The rammer is used to extract unfired rounds or cartridge cases which cannot be ejected by the extractor. To extract a cartridge case which cannot be ejected by the extractor, the bottom of the inside of the case is tapped lightly until it is loosened and can be pushed out of the chamber. No. 2, standing at the breech, receives the cartridge case in both hands. To extract an unfired round, the procedure prescribed in paragraph 38 will be followed.

SECTION IX

ADDITIONAL INFORMATION ON THE SERVICE OF THE
PIECE

■ 29. ACCURACY IN LAYING.—Sighting and laying instruments, fuze setters, and elevating and traversing mechanisms will be manipulated so as to minimize the effects of lost motion. This requires that the last motions in setting instruments and in laying be always in the directions prescribed. To insure accurate laying, the gunner and any other cannoneers who have duties in connection with laying the piece invariably will be required to verify the laying after the breech has been closed. When the piece must be established on uneven ground, it is desirable for accurate firing that the three points of support be leveled by pioneer work.

■ 30. TO FIRE BY INDIVIDUAL SECTIONS WITH DIRECT LAYING AT MOVING TARGETS.—*a.* The chief of section observes the target, estimates its range and speed, and gives such directions and commands to the cannoneers as will aid them in laying and firing the piece.

b. The gunner lays for direction with the panoramic sight; No. 1 lays for range with the elbow telescope, using the range lines. (This automatically compensates for the site of the target.) The piece is kept laid continuously by the gunner and No. 1. No. 2 loads the piece and No. 5 operates the breech and fires the piece, as rapidly as possible, without regard to the operations of laying.

c. At the command of the chief of section RIGHT (LEFT) (SO MUCH), the gunner sets the deflection change ordered (having previously set his deflection at zero), and tracks the target by traversing with the traversing handwheel. For the first round, being on the target and No. 1 having called "Set," the gunner gives the command FIRE. Subsequent rounds are fired without further command.

d. No. 1 using the elevating handwheel keeps the elbow-telescope range line for the announced range continuously on the base of the target. For the first round only, No. 1 calls "Set" when the appropriate range line is on the base of the target.

e. Firing is begun at the chief of section's command **COMMENCE FIRING** and continues until the command **CEASE FIRING** is given.

f. The chief of section observes the fire and gives such changes in deflection and range as are indicated thereby. These changes are applied on the scale of the panoramic sight and in the reticule of the elbow telescope by the gunner and No. 1, respectively, without stopping the fire. For maximum effectiveness, an available cannoneer should be used to set changes in deflection, thus permitting the gunner to track the target continuously.

■ 31. **FIRE AT WILL.**—*a.* The piece being in position and prepared for action, in case of sudden attack, when the target appears at a range of less than 500 yards, the executive may command: 1. **TARGET (SO AND SO)**, 2. **FIRE AT WILL**. The chief of section repeats this command.

(1) The gunner keeps the piece laid directly on his portion of the target throughout the firing. No. 1 keeps the 500-yard line of the elbow telescope on the base of the target. No. 3 sets corrector 30, range zero. No. 4, if shrapnel is used, sets fuzes continuously.

(2) Firing is commenced at the command of the chief of section: **NO. (SO AND SO) FIRE**. The piece is loaded and fired as rapidly as possible until the command **CEASE FIRING**, or until the enemy disappears from view or actually reaches the piece.

b. In fire at will, refinements of laying are not attempted, rapidity of fire being of primary importance. Shrapnel, if available, will be used. If shrapnel is not available, shell, charge IV, set at *delay* will be used. In general, the procedure in firing shell is the same as with shrapnel except that No. 1 lays well below the lowest visible element of the target.

■ 32. **AIMING STAKES.**—When a suitable natural aiming point is not visible, the piece, after it has been laid initially for direction, is referred to the aiming stakes as described in paragraph 23b (5). Two aiming stakes are used for each piece. Each stake is equipped with a light for use in firing at night. One stake is set up in a convenient location at least 100 yards from the piece. The other stake is set up at the

midpoint between the first stake and the piece, and is lined in by the gunner so that the vertical hair of the sight and the two aiming stakes are all in the same vertical plane. Any lateral displacement of the piece during firing can then be detected easily and corrected for as indicated in paragraph 33. For night use, the lights should be adjusted so that the far one will appear several feet higher than the near one. The two lights thus will clearly establish a vertical line on which the vertical hair of the sight can be laid.

■ 33. CORRECTION FOR LATERAL DISPLACEMENT.—When the gunner notes that the piece is out of line with reference to the aiming stakes, he reports that fact to the chief of section. The gunner continues to lay the piece, using the far stake, until correction is authorized by the executive. The piece is then moved back into its original position, or a correction is made as follows: The gunner lays the piece by using the far stake, then refers to the near stake, and finally lays on the far stake with the new reading. The stakes are then realigned by moving the near stake. This correction is effective only when the stakes have been equally spaced as indicated in paragraph 32.

■ 34. REPORTING ERRORS.—Each member of the howitzer squad should be constantly impressed with the importance of reporting promptly to the chief of section any errors made by members of the howitzer squad. The chief of section will report errors immediately to the executive as prescribed in paragraph 22*b* (8).

■ 35. CEASE FIRING.—The command CEASE FIRING normally is given to the howitzer squad by the chief of section, but in emergencies anyone present may give the command. At this command, *regardless of its source*, firing will cease immediately. If the piece is loaded, the chief of section will report that fact to the executive. Firing is resumed at the announcement of the range or elevation.

■ 36. SUSPEND FIRING.—The command SUSPEND FIRING is given only when the battery is firing on a prearranged schedule and a temporary halt in the firing is desired. At this command, firing is stopped, but settings continue to be altered in con-

formity with the schedule. If the piece is loaded, the chief of section will report that fact to the executive. Firing will be resumed at the command **RESUME FIRING**.

■ **37. CHANGES IN DATA DURING FIRING.**—Except in fire at moving targets, the announcement to the gun squad of any new element of firing data serves as a signal to stop all firing *previously ordered but not yet executed*. If the piece is not loaded at the announcement of a new element of firing data, the new data will be set off and firing resumed at the announcement of the range or elevation. If the piece is loaded with shrapnel, and the new data require a change in the fuze setting, the piece will be unloaded (par. 38). If no change in fuze setting is required or if the piece is loaded with shell, the new data are set off, and the firing is resumed.

■ **38. TO UNLOAD THE PIECE.**—*a.* When the command **UNLOAD** is given, No. 1 brings the piece to the horizontal position, No. 5 opens the breech slowly, and No. 2, standing at the breech, receives the ejected round with both hands in the case of shrapnel and the cartridge case in the case of shell. With shell, and with shrapnel whenever the extractor fails to eject the round, the rammer must be used.

b. No. 5 takes the sponge-and-rammer staff and inspects the rammer head to see that it is thoroughly clean and that the recess for the fuze is free from any foreign matter. Under the direct supervision of an officer, he inserts the rammer head in the bore and pushes it carefully in until it encloses the fuze and comes in contact with the projectile. He pushes the rammer head gently against the projectile and, if necessary, taps the rammer staff lightly to dislodge the projectile. He then pushes the projectile out of the breech while No. 2, standing at the breech, receives the round in both hands.

■ **39. MISFIRES.**—In the event of a misfire, at least three attempts to fire the primer will be made. The breechblock will not be opened until at least 2 minutes have elapsed after the last attempt to fire (AR 750-10). Rounds which have misfired will be removed from the battery position and disposed of as prescribed in TR 1370-A.

■ 40. **AMMUNITION.**—Ammunition must be protected from damage, especially to rotating bands and cartridge cases. When it is received, it should be sorted into lots and placed in the best available storage. Ammunition data cards should be retained until after all ammunition pertaining thereto is expended. Protection should be provided against moisture, dirt, the direct rays of the sun, and, as far as practicable, against hostile artillery fire and airplane bombs. Protection against weather, dirt, and sun may be obtained by the use of paulins below and above the ammunition, and suitable dunnage below and between the layers. Protection against hostile fire may be obtained by the use of small dispersed stacks, trenches, or dugouts.

■ 41. **THE SECTION DATA BOARD.**—When positions are occupied for more than a few hours, a data board may be used by each section for recording such items as base deflection, calibration corrections when appropriate, minimum range or elevation, data for primary defensive fire missions, and other data the need for which may be urgent.

■ 42. **FIRING FROM THE WHEELS.**—In emergencies, the pieces may be fired from the wheels, provided the sight chest is first removed from the trails. In this case, the chief of section must watch the degree of traverse and elevation closely to be sure that the gun in recoil will not strike the trails. As soon as practicable, the piece should be placed on the firing base and the trails opened.

SECTION X

CARE AND MAINTENANCE OF MATÉRIEL

■ 43. **GENERAL.**—*a.* This section covers such operations in the care and maintenance of the M3A1 howitzer as may be performed by a battery in the field. With obvious modifications it applies equally to the M2A1 and M3 carriages.

b. Complete instructions for battery maintenance, including disassemblies, are found in the Technical Regulations and Standard Nomenclature Lists referred to in paragraph 2, especially TR 1305-75E and SNL C-26. Operations not

covered therein are the function of the Ordnance Department.

c. In general, the battery is charged with *preventive* maintenance, that is, with routine cleaning, lubricating, and preserving. Certain classes of repairs, adjustments, and replacements of parts may also be made under the direction of an officer or the chief mechanic. Parts which may be drawn by a battery for replacement purposes are indicated in SNL C-26 by the symbol %. Unless specifically prohibited, such parts may be installed by or under the direction of the battery mechanic. For routine care and maintenance, specific duties are assigned to individuals, squads, or sections, and a strict accountability for the proper performance of such duties is enforced.

d. In general, the following operations may be performed within the battery:

- (1) Draining and replenishing recoil liquid.
- (2) Disassembly, maintenance, and assembly of breech and firing mechanisms.
- (3) Removal or replacement of the following assemblies:
 - (a) Top sleigh.
 - (b) Tube assembly.
 - (c) Breech ring.
 - (d) Bottom sleigh.
- (4) Removal, adjustment, and replacement of the equilibrators.
- (5) Maintenance and adjustment of brake mechanism.
- (6) Removal, care, and maintenance of wheels and wheel bearings, including tires.
- (7) Maintenance of wheel latch mechanism.
- (8) Removal and replacement of gear-case covers for cleaning gear cases.
- (9) Minor operations necessary to replace certain parts such as flexible joints, traversing and elevating stops, cradle trunnion pins, firing-base lock latch and lever, etc.

■ 44. CLEANING.—a. Dirt and grit accumulated in traveling or from the blast of the piece in firing settle on the bearing surfaces, and in combination with the lubricant form a cutting compound. Powder fouling attracts moisture and has-

tens the formation of rust. Dirt on nonbearing surfaces can usually be removed by water; lubricated or other greasy parts must be cleaned with dry-cleaning solvent applied with a rag. The following cleaning materials are issued by the Ordnance Department for use in the field:

(1) *Soda ash* (dehydrated sal soda).—Used for cleaning the bore, breech mechanism, and firing mechanism after firing.

(2) *Dry-cleaning solvent*.—For removing grease. It is preferred to kerosene because it does not leave a corrosive film, and to gasoline because it is less inflammable.

(3) *Crocus cloth*.—This is the coarsest abrasive permitted for cleaning rust and stains from bearing surfaces.

(4) *Emery cloth*.—Used for cleaning unfinished or *non-bearing* steel surfaces only. Issued in five degrees of coarseness, of which 00 is the finest.

(5) *Burlap, jute*.—Used for cleaning the bore.

(6) *Cotton waste, clean rags, and sponges*.—For general cleaning purposes.

b. A division of duties for members of the howitzer squad in routine cleaning and maintenance is as follows:

(1) The gunner—the telescope, telescope mount, sight bracket, and other sighting and laying equipment, including the gunner's quadrant.

(2) Nos. 1 and 2—the breech mechanism, the firing mechanism, the breech ring, and the tube assembly.

(3) No. 3—the fuze setter.

(4) Nos. 4 and 5—the elevating and traversing mechanism, and the recoil slides and grooves.

(5) Higher-numbered cannoneers assist in the operations as directed by the chief of section.

c. Before firing, at lulls during firing, and immediately after firing, the piece should be thoroughly cleaned and lubricated. At other times it should be cleaned at intervals not exceeding 2 weeks, depending upon its use and its condition. The bore, breech mechanism, and firing mechanism should be cleaned as described in paragraph 48b. The top sleigh, tube assembly, breech ring, and bottom sleigh should be removed, cleaned, and lubricated. Particular emphasis should be placed on the proper cleaning, drying, and lubricating of the inter-

rupted threads of the tube assembly and of the breech ring, the slides, and the unpainted bearing surfaces of each assembly.

d. The exposed gears of the elevating and traversing mechanisms should be cleaned with dry-cleaning solvent, dried, and coated with graphite lubricating grease. After the gears are lubricated, the systems should be exercised to insure complete and even distribution of the lubricant.

e. The moving parts of the equilibrators, firing base, firing-base lock, cradle lock, and wheel latch mechanism should be cleaned and lubricated in order to insure their positive and ready action.

■ 45. LUBRICATION.—*a.* To facilitate identification, all oil holes and grease fittings should be made conspicuous by circling with bright red enamel.

b. Light limber, M2.—At least once every 6 months, the wheel bearings should be cleaned, and the bearings and the hub packed with fiber wheel-bearing grease. Every 2 weeks, or more often if necessary, the following lubrication operations should be performed:

(1) The pressure lubricating gun filled with mineral lubricating grease is used on the spring shackles (2 fittings) and the limber-frame brackets (4 fittings).

(2) The oiler filled with lubricating oil is used on the doubletree bolt and the moving parts of the pintle.

(3) Oil is brushed on the edges of the spring leaves.

c. Light caisson, M1.—At least once every 6 months the wheel bearings should be cleaned, and the bearings and the hub packed with fiber wheel-bearing grease. Every 2 weeks, or more often if necessary, the following lubrication operations should be performed:

(1) The pressure lubricating gun filled with mineral lubricating grease is used on the brake cam shaft, brake conduit, brake shaft, caisson spring pins, caisson spring shaft, and spring shackle pins (total of 12 fittings).

(2) The oiler filled with lubricating oil is used on the exterior moving parts of the brake mechanism, moving parts of the pintle, and moving parts of the pole prop.

(3) Oil is brushed on the edges of the spring leaves.

(With obvious modifications this chart applies also to the M2A1 and M3 carriages.)

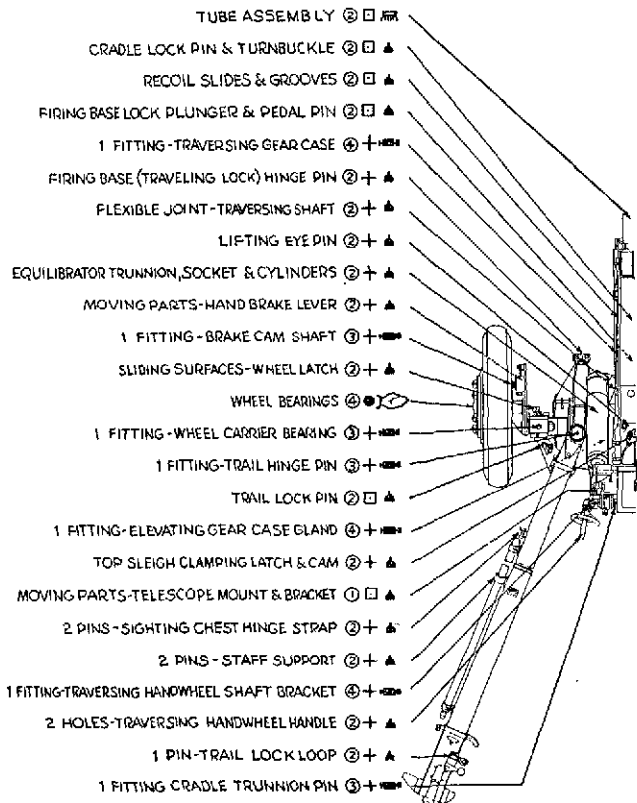

LUBRICANTS

- ① NEUTRAL OIL
- ② LUBRICATING OIL-USE LIGHT (SAE-20) WHEN TEMPERATURE IS BELOW 50°F. OR HEAVY (SAE-50) WHEN ABOVE 50°F.
- ③ MINERAL LUBRICATING GREASE
- ④ FIBER WHEEL BEARING GREASE
- ⑤ GRAPHITE LUBRICATING GREASE

HOW APPLIED

- ▲ OILER
- 𠄎 PRESSURE LUBRICATING GUN
- 𠄎 BRUSH OR CLOTH
- 𠄎 HAND PACKING

FIGURE 6.—Lubrication

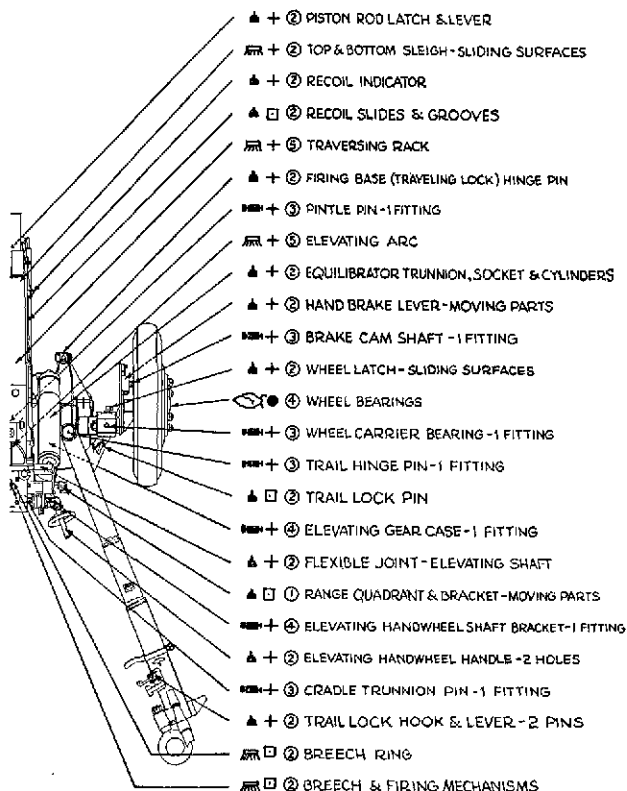

WHEN APPLIED

- DAILY DURING CONSTANT SERVICE, OTHERWISE EVERY TWO WEEKS
 + EVERY TWO WEEKS
 ● EVERY SIX MONTHS

NOTE - After firing or washing, lubricate tube assembly, breech and firing mechanisms, slides, telescope mount and range quadrant brackets, exposed gears, and unpainted bearing or sliding surfaces. Immediately before firing and during lulls, clean and oil all bearing and sliding surfaces of breech, firing and sighting mechanisms and cradle.

chart, 75-mm howitzer, M3A1.

d. Lubrication instructions for the howitzer and carriage, M3A1, are covered in figure 6. While being lubricated, parts should be exercised to insure complete and positive distribution of the lubricant. Whenever time is available prior to entering into action, all sliding and bearing surfaces which come into play in the functioning of the howitzer and carriage should be cleaned and oiled to insure their free and easy operation. Always after passing through water, the wheel bearings should be cleaned and repacked with fresh grease.

■ 46. PROTECTION AGAINST CHEMICALS.—Whenever chemical attacks are anticipated, all bright parts should be covered with oil. After a gas attack, the oil is wiped off and fresh oil applied. If mustard or other persistent gas is used, absorbent objects may be deeply contaminated, and even hard surfaces may be dangerous for 6 to 8 days if the chemical is not neutralized. Surfaces should be sprinkled with calcium hypochlorite or chloride of lime, or painted with a whitewash made from either. After 2 to 6 hours the lime is washed off and the matériel rinsed thoroughly with water. When large quantities are available, warm (but not boiling) water should be used instead of calcium hypochlorite or chloride of lime. In all cleaning operations, the gas mask and special gas-proof gloves must be worn. All cleaning rags, sticks, etc., are disposed of by *burying*. They must not be burned as the heat will disseminate dangerous vapor.

■ 47. RECOIL MECHANISM.—a. *General*.—Battery maintenance of the recoil mechanism is limited to exterior cleaning and lubricating, and to draining and filling with recoil oil. Only the heavy low-pour-point recoil oil as issued by the Ordnance Department may be used in the recoil mechanism. It is especially important that this oil be kept free of dirt, water, and air bubbles, and that it be not mixed with other oils. A full reserve of oil for the recoil system amounts to approximately one-half the contents of the screw filler. In using the screw filler, care must be exercised to prevent crossing of the threads.

The screw handle must be turned with both hands. The amount of oil reserve in the system is shown by the position of the oil index with reference to the extension on the oil-index follower assembled in the recuperator cylinder head, as follows:

(1) *No reserve.*—The indicator is at the bottom of the recess. The howitzer must not be fired in this condition.

(2) *Full reserve.*—The end of the indicator is flush with the extension on the oil-index follower.

(3) *Excess reserve.*—The oil index does not of itself show when there is an excess of oil reserve, as the addition of excess oil does not move the index out beyond the follower. The piece must not be fired with an excess reserve.

b. Operations prior to firing.—(1) The presence of a full reserve of oil must be insured. When the index is flush with the follower, to insure that there is not an excess reserve or that the index is not stuck, oil should be drained off until the index starts to move into its recess. Oil is then replenished, the operation being stopped just as the index comes flush with the end of the follower.

(2) The rear end of the recoil cylinder, the filling-and-drain plug hole, and the oil-index recess should be examined for oil leakage. The presence of a few drops of oil is not important, but if there is undue leakage the piece must not be fired, and the condition should be reported to the ordnance maintenance company.

(3) The sleigh slides should be lubricated.

c. Operations during firing.—(1) During firing, the recoil mechanism should be maintained at full reserve, and the slides kept clean and properly lubricated.

(2) The chief of section constantly verifies the complete return of the piece to battery. Periodically, he measures the length of recoil by releasing the recoil indicator which wipes off chalk or grease which has been placed on the cradle. For the M3A1 carriage the maximum length of recoil is 31 inches and the normal length is 29 inches.

(3) The chief of section constantly observes the behavior of the recoil mechanism in firing, and takes such action in the case of malfunctioning as is indicated below:

Malfunction	Cause	Correction
Oil index projects less than the required distance.	(1) Loss of oil reserve. (2) Loss of gas pressure either through the cylinder rear head or past the floating piston.	(1) Drain the remainder of the reserve oil and refill. (2) Gas escaping by the floating piston is indicated by an emulsified condition of the reserve oil drained off. If in filling the mechanism the oil index does not move out and the oil screw filler works easily, the gas pressure has been lost. Substantiate this by an attempt to drain the mechanism. Oil will not spurt out unless some pressure is present. Refer to ordnance maintenance company for repair.
Oil index remains stationary when the reserve is pumped in against evident pressure.	The packing is too tight or the index is broken or locked by some foreign substance.	Drain off all reserve oil and refill. While injecting the oil, tap the oil index gently with each turn of the screw filler. If the oil index fails to move after employing the screw filler, refer the matter to the ordnance maintenance company. However, the piece may be fired in an emergency by draining off the reserve oil and refilling with one-half the capacity of the screw filler.
Howitzer returns to battery with too great a shock.	Excess reserve caused by expansion of oil as a result of rapid firing.	Withdraw oil until the index is halfway in. When the mechanism has cooled off, refill to normal.
Howitzer fails to return to battery.	(1) Leakage of oil past recoil piston. (2) Insufficient reserve, dry or scored bottom sleigh slide or piston rod, excessive friction, or loss of nitrogen pressure.	(1) Remove cap screw in rear head of recoil cylinder, elevate piece and allow oil to escape through relief opening. (2) Establish a full reserve. If the howitzer fails to return to battery, examine the bottom sleigh slides and piston rod. If after lubricating or removing foreign matter the howitzer still fails to return to battery, refer to ordnance maintenance company.

■ 48. TUBE ASSEMBLY, BREECH MECHANISM, AND FIRING MECHANISM.—*a. Operations during firing.*—(1) During firing, all exposed bearing surfaces must be kept clean and covered with a thin film of lubricating oil.

(2) Whenever the rate of firing permits, the bore should be swabbed with clean water and a sponge.

(3) The chief of section should constantly observe for malfunctioning of the matériel. The causes and corrections of malfunctioning of the breech and firing mechanisms are given in the following table:

Malfunction	Cause	Correction
Fails to fire, no percussion on primer.	Broken firing spring; broken or deformed firing pin.	Disassemble firing lock and replace broken or deformed part.
Fails to fire until primer is struck several times.	(1) Firing mechanism parts not working freely. (2) Weak firing spring.	(1) Disassemble firing lock and examine for burrs and rough spots. If found, remove with crocus cloth or an oilstone. Wash parts with dry-cleaning solvent, dry and lubricate before reassembly. (2) If correction (1) above does not remedy condition, replace firing spring.
Fails to fire when proper percussion on primer is obtained (misfire).	Defective primer.	Make three attempts to fire the primer, then wait 2 minutes before opening breech and replacing round. (See par. 30.)
Fails to extract empty case.	Broken extractor.	Gently ram the case out. Examine the edge of the chamber for burrs. Remove burrs, if any, with crocus cloth or an oilstone. Replace extractor.

b. Operations after firing.—(1) As soon as possible after firing, the breechblock and firing mechanism should be disassembled and all parts cleaned and lightly oiled. The bore should be thoroughly cleaned while assembled to the carriage. (Par. 44c.)

(2) The bore, breech mechanism, and firing mechanism are washed with a solution of $\frac{1}{2}$ pound of soda ash or 1 pound of sal soda in 1 gallon of water. Cleaning the bore is accomplished by means of a swab of burlap stitched around the end of the rammer staff. No attempt should be made to remove copper fouling. When all powder fouling has been removed, the bore should be swabbed with clear water and then wiped dry. Finally, it should be lightly coated with

lubricating oil, either light or heavy, depending on the weather. The cleaning may have to be repeated on successive days if there is evidence of sweating. If the piece is not to be kept in constant service, the bore should be slushed with rust-preventive compound instead of with oil.

■ 49. WHEELS AND BRAKES.—*a. General.*—The care and maintenance of the wheel mechanism, including tires and brakes, is a function of the battery. Tire pressure should be maintained at 30 pounds. Tires are removed at least once a year and the disk and rim cleaned and painted. Every 6 months, or oftener if necessary, the wheel hubs should be removed, the old grease flushed out, new grease pressed into the bearings and the hub by hand, and the wheel bearings adjusted. The proper adjustment and operation of the brake system should frequently be checked.

b. Test of bearing adjustment.—At all halts during marching the wheel hubs should be felt for overheating. During the march the wheels should be observed to ascertain that they are running true without side play. When the bearings are adjusted, the adjustment should be checked by placing a bar between the raised tire and the ground, at the same time holding one finger on the cage of the outer bearing. When in working the bar up and down a barely perceptible shake is felt, and the wheel will rotate when given a slight spin, the adjustment is correct.

c. Brake mechanism.—Brake adjustment is accomplished by rotating the adjusting wedge. Prior to adjusting the brake mechanism, wheel bearings should be checked for proper adjustment and the brake mechanism lubricated. At all times, lubrication of the brake cam and rollers must be held at the correct amount to avoid saturating the brake lining with grease. The procedure for adjustment is as follows:

- (1) Set the brake lever at the full released position.
- (2) Jack up the wheel.
- (3) Adjust the wedge until a drag is felt on the wheel. Then back off just enough so the brake does not drag. Brakes must be cold.

■ 50. MISCELLANEOUS PARTS OF CARRIAGE.—a. Equilibrators.—

(1) The outer surfaces of the lower cylinder must be kept clean and lubricated with oil. Proper lubrication of the trunnion pin at the top and the socket at the bottom must be maintained. The battery is prohibited from performing any operation other than the removal or adjustment of the equilibrators.

(2) The following procedure should be observed in adjusting an equilibrator:

(a) Place the howitzer at zero elevation.

(b) Insert the equilibrator assembling bolt through the socket bearing of the bottom carriage and through the barrel of the equilibrator. Advance the bolt until it comes in contact with the equilibrator spring guide tube plug, and screw the bolt into the plug as far as it will go.

(c) Elevate the howitzer until the equilibrator trunnion pin is clear of the bearing in the top carriage.

(d) Release the equilibrator trunnion pin lock and make the desired adjustment by screwing the trunnion pin in for lesser tension or out for greater tension.

(e) After the adjustment is completed reengage the lock, lower the cradle to seat the equilibrator trunnion pin, and remove the assembling bolt. (CAUTION.—Do not attempt to remove the assembling bolt until the cradle is seated and the spring tension is released.)

(3) An equilibrator is removed from the carriage by the procedure outlined in (2) above, except that during operation (2) (c) the howitzer is elevated to its maximum extent and the equilibrator assembly removed.

b. Elevating and traversing mechanisms.—Every 6 months the covers of the gear cases should be removed, the old grease cleaned out, and the cases repacked with lubricant of the prescribed type. Battery personnel are permitted to make the disassembly necessary to clean the gear cases, to replace the flexible joints, and to clean the shaft brackets. If the backlash in either handwheel exceeds one-quarter turn, the ordnance maintenance company should be requested to adjust the system. Whenever the exposed gears are being cleaned

they should be examined for broken or deformed teeth and to see that the arc or rack stops are in place and in good condition.

■ 51. SIGHTING AND FIRE-CONTROL EQUIPMENT.—*a. General.*— Especial care is required to insure the positive and accurate functioning of the sighting and fire-control mechanisms. Care must be exercised to prevent denting the soft metal surfaces or scratching the glasses. Dirt should be removed from optical surfaces by brushing lightly with a camel's-hair brush. Oil or grease should be removed from glass by applying alcohol, or if alcohol is not available by breathing on the glass and then wiping lightly with lens paper or a clean soft cloth. The unpainted steel surfaces should be kept covered with a light film of high-grade lubricant to prevent corrosion. In general, the sights are correct—

(1) *In direction*, if the deflection scales read zero when the line of sighting is in a plane parallel to the vertical plane passing through the axis of the bore.

(2) *In elevation*, if the algebraic sum of the range and site settings indicates the same angle above the horizontal that is measured with an accurate gunner's quadrant on the tube.

(3) If there is no excessive lost motion between the sights and the tube.

b. Testing equipment.—Equipment used in testing sights consists of bore sights and a gunner's quadrant. The target for bore sighting may be a distant terrain object, more than 1,000 yards away, or a test target for use in close proximity. In the latter case the displacement of the axis of sighting from the axis of the bore must be correctly shown. For this howitzer the panoramic telescope displacement is 14 inches to the left and 6.42 inches above the axis of the bore. The elbow telescope is 12.375 inches to the right and 6.42 inches above the axis of the bore. An aiming stake with a wooden block or marker attached makes a suitable test target. In direction tests it may be canted as the carriage is canted, making leveling of the trunnions unnecessary. Tests can be made without the bore sights by sighting through the firing pin recess or a brass cartridge case with the primer removed, using improvised cross hairs at the muzzle.

c. Test of the gunner's quadrant.—To test the gunner's quadrant, set the scales at *zero*, place it on the quadrant seat of the howitzer, and level the quadrant bubble by means of the elevating handwheel. Then reverse the quadrant on its seat. The bubble should center itself. If it does not it should be adjusted at the earliest opportunity by the ordnance maintenance company. If it must be used, apply a correction in the appropriate sense equal to one-half of the measured error determined in the end-for-end test.

d. Telescope mount, M16 and panoramic telescope, M1.—Battery personnel are forbidden to disassemble any part of the telescope or telescope mount, but are permitted to perform certain adjustments. The following procedure may be used to insure accuracy of the sighting and laying mechanism:

(1) *Panoramic telescope and telescope mount assembly.*—
(a) Level the carriage trunnions and tube with the gunner's quadrant.

(b) Bore-sight, placing the test target in alinement with the bore, or note a distant terrain object which is in alinement.

(c) Set all scales and micrometers at zero and center the bubbles.

(d) Look through the telescope. If the intersection of the cross hairs is on the appropriate part of the target the adjustment is correct. If not, make tests and adjustment of individual parts as explained in (2) to (5) below. Each test should be started with the tube and trunnions level and the bubbles centered.

(2) *Cross level of the telescope mount.*—(a) Center the cross-level bubble and lay the vertical cross hair with zero deflection on the appropriate part of the testing target or on a distant terrain object.

(b) Elevate the howitzer to its maximum and level the longitudinal bubble. The cross-level bubble should be centered and the vertical cross hair should not have moved.

(c) If the vertical hair has moved either to the right or to the left, determine the error by turning the cross-leveling knob by small trial movements until the vertical hair remains on its target while the piece is elevated and depressed. Note the position of the bubble. If it is not centered within one

division it should be repaired by the ordnance maintenance company. However, it may be used by setting the bubble in the position determined in the above test instead of in its true center.

(3) *Longitudinal level of the telescope mount.*—(a) With 1,600 m deflection, lay the vertical cross hair on a plumb bob line and center the longitudinal bubble.

(b) By means of the elevation-micrometer knob of the telescope move the vertical cross hair along the plumb bob line. The vertical hair should not move either to the right or to the left.

(c) If the vertical hair moves, determine the error by moving the longitudinal-leveling knob by trial adjustments until the vertical hair remains on the plumb bob line. Note the position of the bubble. If it is not centered within three divisions it should be repaired by the ordnance maintenance company. However, it may be used by setting the bubble in the same relative position determined in the above test instead of in its true center.

(4) *Panoramic telescope for direction.*—(a) If the vertical cross hair of the telescope is to the left of the bore-sighted target with zero settings, put it on by loosening the locking nut on the sight bracket and adjusting the headless screw. Tighten the locking nut and recheck.

(b) If the vertical cross hair of the telescope with zero settings is to the right of the bore-sighted target, put it on by the deflection knob. Loosen the screw in the knob and slip the micrometer around until the zero graduation registers opposite the index, being careful not to disturb the cross hair. Retighten the set screw and recheck.

(c) Periodically, check all sight brackets of the battery with a single telescope and mount, and apply any necessary correction of the vertical hair by loosening the locking nut on the brackets and adjusting the headless screw. The telescope for each weapon should then be adjusted as in (b) above.

(5) *Panoramic telescope for elevation.*—If the horizontal cross hair of the telescope with zero settings and bubbles leveled is not on the bore-sighted target, put it on by turning the elevation knob of the telescope. Then loosen the three

set screws on the knob and slip the knob around until the zero graduation registers opposite the index, being careful not to disturb the cross hair. Retighten the set screws and recheck.

e. Range quadrant, M3, and elbow telescope, M5.—As with the telescope and mount, battery personnel are only permitted to perform certain tests and adjustments with the range quadrant and elbow telescope. The following procedure may be used to insure accuracy in this testing and adjusting:

(1) *Range quadrant, general.*—(a) Lay the tube horizontal and level the trunnions using the gunner's quadrant.

(b) If the angle-of-site bubble is centered when the angle-of-site scales are set at 300 and the range and elevation scales are set at zero, the range quadrant is in adjustment. If not, adjust as indicated in (2) to (4) below.

(2) *Cross level of range quadrant.*—(a) Install the elbow telescope.

(b) Using any part of the reticule of the elbow telescope, such as the left edge of the letter N, repeat test *d* (2).

(3) *Range quadrant for elevation and angle of site.*—(a) Lay the tube horizontal and level the trunnions.

(b) Center both bubbles.

(c) If the elevation scale is not at zero, loosen the three screws in the end of the micrometer knob, hold the knob, and slip the micrometer until its zero graduation and the index are in agreement. Retighten the screws.

(d) If the angle of site does not indicate 300, loosen the screw in the end of the micrometer knob, hold the knob, and slip the micrometer until the zero graduation and the index are in agreement. Retighten the screw.

(4) *Elbow telescope.*—(a) Level the carriage trunnions and the tube with the gunner's quadrant.

(b) Bore-sight, placing the test target in alinement with the bore, or note a distant terrain object which is in alinement.

(c) Look through the elbow telescope. The line marked N should be on its proper part of the target (6.42 inches above axis of bore). If not in adjustment return it to the ordnance maintenance company for repair.

(d) With the azimuth indexes coinciding, the center of the telescope (clear space between horizontal lines) should be on its proper portion of the testing target or distant object. If the telescope points to the right of the bore-sighted target, put it on the target by loosening the locking nut and adjusting the headless screw on the range quadrant bracket. If the telescope points to the left of the bore-sighted target, put it on with the azimuth-worm knob, loosen the two set screws, and slide the movable azimuth index until it coincides with the fixed index.

f. Bracket fuze setter, M1916A2.—(1) To eliminate looseness in either worm gear, loosen the set screw, and with a screw driver turn the adjusting plug clockwise. Retighten the set screw. The range crank should not fall on its own weight.

(2) To eliminate end play in either worm shaft, remove the crank handle or knob by driving out the tapered pin, loosen the set screw, and tighten the bearing cap with a teat wrench. Retighten the set screw. Replace the handle or knob.

