

MHI
Copy 2

FM 23-75
16 APR 1940

J. King
WAR DEPARTMENT

BASIC FIELD MANUAL

✱
37-MM GUN, M1916

Q/40

FM 23-75

BASIC FIELD MANUAL

37-MM GUN, M1916

**Prepared under direction of the
Chief of Infantry**



**UNITED STATES
GOVERNMENT PRINTING OFFICE
WASHINGTON : 1940**

**For sale by the Superintendent of Documents, Washington, D. C.
Price 25 cents**

WAR DEPARTMENT,
WASHINGTON, *April 16, 1940.*

FM 23-75, 37-mm Gun, M1916, is published for the information and guidance of all concerned.

[A. G. 062.11 (10-10-39).]

BY ORDER OF THE SECRETARY OF WAR:

G. C. MARSHALL,
Chief of Staff.

OFFICIAL:

E. S. ADAMS,
Major General,
The Adjutant General.

TABLE OF CONTENTS

	Paragraphs	Page
CHAPTER 1. MECHANICAL TRAINING:		
Section I. Description-----	1-3	1
II. Dismounting and mounting, dis- assembling and assembling, op- eration of the piece-----	4-6	5
III. Care and cleaning-----	7-10	12
IV. Functioning-----	11-16	15
V. Defects and stoppages-----	17	17
VI. Instruments and accessories-----	18-23	19
VII. Ammunition-----	24-31	31
CHAPTER 2. DRILL FOR PLACING GUN IN ACTION----	32-42	34
CHAPTER 3. MARKSMANSHIP:		
Section I. Preliminary instruction-----	43-54	45
II. Examination-----	55-60	66
III. Qualification course, gunner's test-----	61-73	68
IV. Qualification course, expert's test-----	74-78	77
V. Targets, ranges, and safety pre- cautions-----	79-80	81
CHAPTER 4. TECHNIQUE OF FIRE:		
Section I. Direct laying-----	81-83	83
II. Indirect laying-----	84-92	87
III. Overhead fire-----	93-98	105
IV. Fire control and adjustment-----	99-105	110
V. Firing against moving targets-----	106-112	120
VI. Other firing methods-----	113-117	126
VII. Range cards-----	118-119	132
CHAPTER 5. FIRING AT FIELD TARGETS:		
Section I. General-----	120-122	136
II. Preparatory exercises-----	123-126	136
III. Firing exercises-----	127-135	138
CHAPTER 6. ADVICE TO INSTRUCTORS:		
Section I. General-----	136-138	142
II. Mechanical training-----	139-142	143
III. Gun drill-----	143	144
IV. Marksmanship-----	144-145	144
V. Firing at field targets-----	146-151	145
VI. Instruction on the sand table-----	152-153	148
INDEX-----		155

BASIC FIELD MANUAL

37-MM GUN, M1916

(The matter contained herein, together with that in FM 23-95, supersedes sections I to IV, inclusive, TR 420-75, June 15, 1926 (including C1, January 2, 1929); TR 1300-37A, April 15, 1933 (including C1, January 2, 1936); the relevant parts of TR 1320-B, April 2, 1927; TR 1350-37A, August 1, 1932; chapters one and two, part two, Basic Field Manual, volume III, May 2, 1932; part four, Basic Field Manual, volume III, August 1, 1932 (including C1, January 3, 1938); and sections XIV to XVII, inclusive, chapter one, Cavalry Field Manual, volume I, January 3, 1938.)

CHAPTER 1

MECHANICAL TRAINING

	Paragraphs
SECTION I. Description.....	1-3
II. Dismounting and mounting, disassembling and assembling, operation of the piece....	4-6
III. Care and cleaning.....	7-10
IV. Functioning	11-16
V. Defects and stoppages.....	17
VI. Instruments and accessories.....	18-23
VII. Ammunition.....	24-31

SECTION I

DESCRIPTION

■ 1. CHARACTERISTICS.—The 37-mm gun, M1916, is a flat trajectory weapon of the field-gun type which fires high-explosive shells or low-explosive shells that weigh slightly more than a pound. Five general methods of transporting the weapon are—

- a. Gun and cart attached, drawn by mule or horse.
- b. Gun and carriage unlimbered, drawn on wheels by the gun squad.
- c. Gun disassembled into three loads consisting of gun and cradle, tripod, and wheels and axle, the first two loads being carried and the wheels and axle being pushed.
- d. Gun and carriage unlimbered and carried in a truck.
- e. Gun and carriage broken down for pack transport.

■ 2. GENERAL DATA.—

Weight of barrel and cradle group.....	pounds...	88
Weight of trails (complete tripod mount), about...do....		86
Weight of wheels and axle.....do....		167
Weight of gun and carriage, complete.....do....		342
Length of barrel.....inches..		29. 13
Length of recoil.....do....		7 to 10
Maximum angle of elevation.....degrees..		22
Amount of traverse to right.....do....		22
Amount of traverse to left.....do....		16
Diameter of wheels.....inches..		37. 75
Over-all length of vehicle.....do....		75
Over-all width of vehicle, trails spread.....do....		57
Over-all width of vehicle, trails closed.....do....		39. 25
Oil capacity of cradle.....pints..		2. 75
Weight of ammunition chest, capacity 16 rounds (empty), approximately.....pounds..		8
Weight of 1 round, HE shell.....do....		1. 57
Weight of 1 round, LE shell.....pounds..		1. 44
Weight of chest containing 16 rounds HE shell...do....		33. 12
Weight of chest containing 16 rounds LE shell...do....		31. 04
Muzzle velocity HE shell.....feet per second..		1, 276
Muzzle velocity LE shell.....do....		1, 312
Rate of fire, maximum (aimed fire)	rounds per minute..	25

■ 3. DESCRIPTION.—*a. Barrel assembly.*—(See figs. 1, 2, 3, and 4.) The barrel assembly consists of the following principal parts: Barrel; breech ring, which is screwed on the rear end of the barrel forming a recess for the breechblock; breechblock, which closes the chamber for firing and carries the extractor mechanism and some of the firing mechanism; jacket and jacket shoe which form the rear support for the barrel, the shoe forming also a guide for the barrel during recoil; clip, which forms the front support and guide for the barrel.

b. Cradle.—The cradle is located below and supports the barrel. It is provided with trunnions and a bracket for attachment to the carriage, and carries a bracket on the left side for attachment of the sight. The recoil cylinder of the

cradle contains the recoil mechanism. A hole is provided through the front cap for filling the recoil cylinder with oil. On the right rear upper surface of the cradle is the drain plug which closes the overflow hole.

c. Tripod.—The tripod comprises the following principal parts: Two trails, front leg, pintle, pintle socket, elevating mechanism, and traversing mechanism.

(1) The trails, right and left, are made of steel of channel iron sections. Riveted to the front of each trail is a trail head, and to the rear end a trail spade. Axle stay clamp blocks, movable in the mortises formed by the trail reinforcement plates, are provided to which the axle stays are hooked when the gun is on wheels. A traversing screw bushing for attachment of the traversing screw through which this screw passes when the trails are closed is on each trail. Also on each trail is a lunette swivel through which the rammer is placed when the gun is drawn by hand, and a singletree eye which is used for joining the gun to the cart.

(2) In addition to the description given in (1) above which is common to both trails, on the left trail are two trail brace chain eyebolts for securing the trail brace to the trail. On the right trail are the front and rear shoulder guard brackets, front and rear sponge staff fastenings, and trail brace locking plate. The front and rear shoulder guard brackets carry the shoulder guard when it is not in position for firing. The sponge staff fastenings, front and rear, are for carrying the sponge staff. The rear fastening has a plunger and spring which hold the sponge staff in place. The trail brace locking plate holds the trail brace when the trails are spread.

(3) The front leg is attached to the pintle socket by two front leg pins. Two elevations in mounting are possible through provision of two different holes for the lower pin. Attached to the lower end of the leg is the front leg float, an enlarged bearing surface to minimize sinking in wet or loose soil when firing from the tripod.

(4) The pintle socket affords the central connection between tripod and axle by engaging the pintle socket bearing (by means of the stud formed on pintle socket). To it also is attached the front leg. The pintle socket and trails form a joint, the three parts being joined together by the

pintle bushing which passes through them, forming a common axis pin.

(5) The pintle, or gun mount, is in the form of a yoke, the upper ends being fitted to receive the cradle trunnions. The pintle is projected downward from the yoke, forming a pivot which fits into the pintle bushing. Projecting through the pintle bushing, the lower end is tapped to receive the pintle retaining plug which holds it in place. The front leg shackle is suspended from the pintle retaining plug to which it is fastened by the front leg shackle screw.

(6) The elevating mechanism is supported on the rear end of a Y-shaped frame which is secured to the pintle at its upper and lower ends. The elevating screw passes through the elevating screw nut which is threaded to receive it, and it in turn is pivoted in the elevating screw nut bracket. Elevation is secured by turning the elevating screw handwheel attached to the upper end of the elevating screw.

(7) An elevating screw nut clamping lever is provided below the elevating screw nut to lock the elevating gear in position. Above the handwheel is the elevating screw latch housing which engages the elevating screw latch catch bracket on the under side of the cradle.

(8) Traversing is accomplished by lateral movements of the elevating screw and nut bracket and the Y-shaped frame, the front ends of the latter being securely attached to the pintle carrying the cradle and barrel. In rear of the point where the elevating screw nut pivots, the elevating screw nut bracket forms a fork and engages the traversing screw nut housing. A traversing screw nut threaded to engage the traversing screw is placed in the traversing screw nut housing, and may be revolved by a traversing handwheel attached to the nut. This turning causes the lateral movement or traverse as the traversing screw is prevented from rotating by the traversing screw lock located in the right traversing screw bearing.

d. Axle and wheels.—The axle has a spindle at each end to which the wheels are fitted. At its center on the lower side is the pintle socket bearing into which the socket stud is placed when the tripod is attached to the axle. An axle coupling pin, attached to the axle by a chain to prevent loss,

passes through a hole in the socket stud, securing the tripod to the axle. On either side of the pintle socket bearing an axle stay is attached. These are hooked into the axle stay clamp blocks on the trails and assist in securing the axle to the tripod. The axle lock which is assembled underneath the pintle socket bearing fits between the flanges of the pintle socket or may be swung out of engagement with it, and is held in the desired position by inserting the axle coupling pin on the proper side of the axle lock stop. When the gun is supported on the wheels in firing the axle lock must be swung out of engagement with the pintle socket (unlocked). At all other times, and especially during transportation of the gun on wheels, the axle lock should be engaged with the pintle socket (locked).

SECTION II

DISMOUNTING AND MOUNTING, DISASSEMBLING AND ASSEMBLING, OPERATION OF THE PIECE

■ 4. DISMOUNTING AND MOUNTING (see figs. 1, 2, 3, and 4).—*a. Dismounting.*—(1) *To dismount cradle assembly from pintle with gun assembled.*—Cock the gun. Open the breech. Insert rammer through bore from the breech. Press down on trunnion cap latches and turn trunnion cap wing nuts to the front. Grasp rammer with the left hand and elevating handwheel with the right. Press in on elevating screw latch with forefinger of right hand and separate elevating screw from elevating screw latch catch bracket by pushing forward on the elevating handwheel. By use of the rammer lift barrel and cradle from the mount.

(2) *To unlock axle lock.*—Draw the axle coupling pin upward about 1 inch, pull axle lock forward, and replace axle coupling pin behind the axle lock stop.

(3) *To remove axle and wheels from tripod.*—Remove gun and cradle from the mount. Pull out axle coupling pin. Straddle the trails. Unhook axle stays and raise the front of the trails slightly. Remove axle and wheels to the front, separating pintle socket bearing from the socket stud. Lower trails to the ground gently as dropping them may injure the front leg shackle.

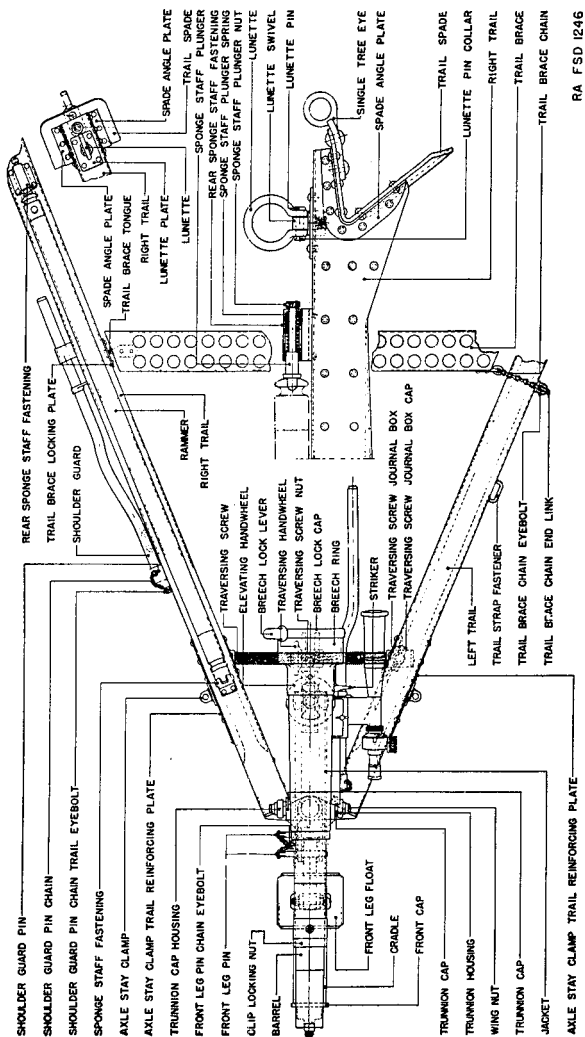

RA FSD 1246

FIGURE 1.—Plan view, 37-mm gun and carriage.

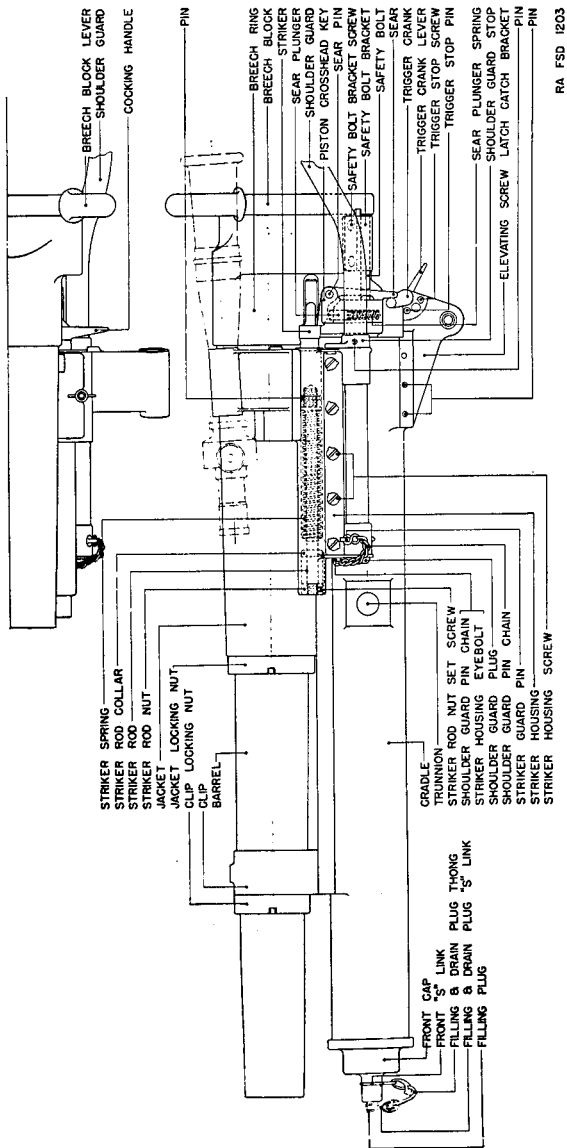

RA FSD 1203

FIGURE 2.—Elevation, side view of gun and cradle, 37-mm gun.

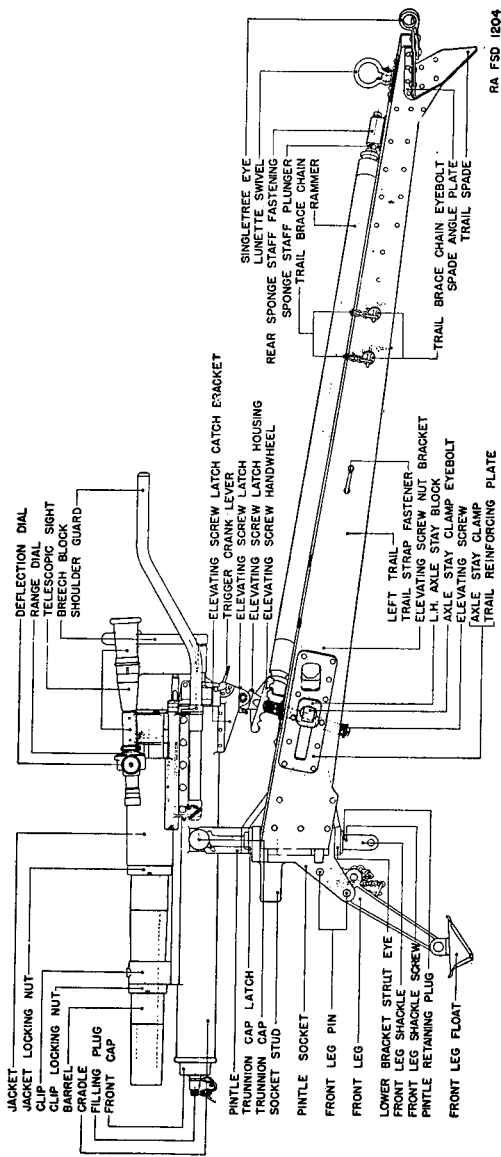

RA FSD 1204

Figure 3.—Side elevation, side view, 37-mm gun.

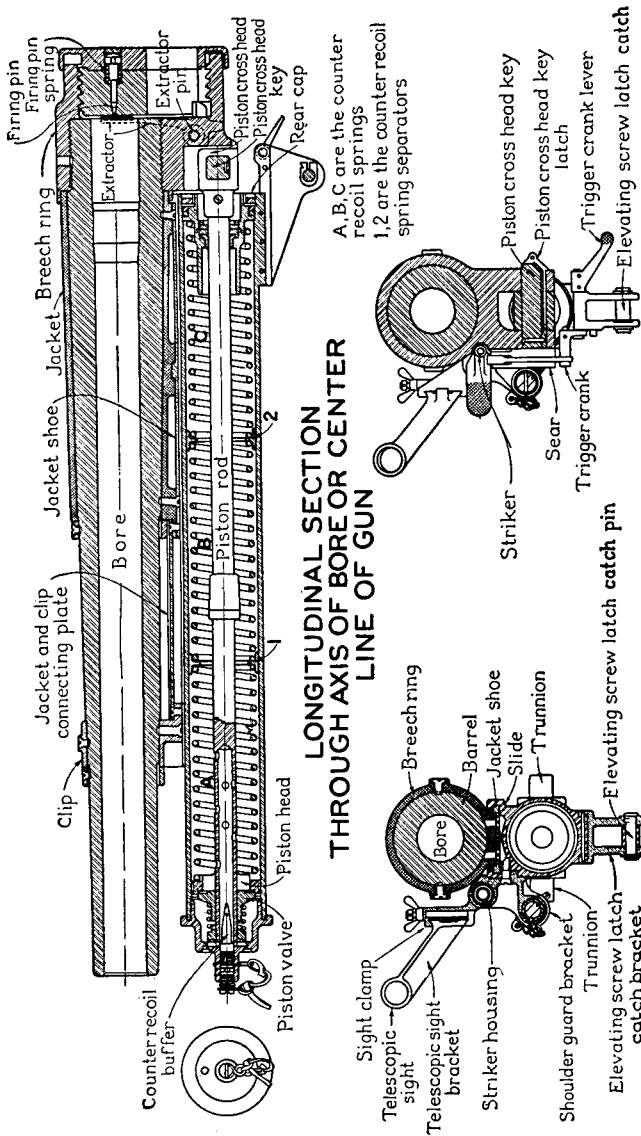

FIGURE 4.—Longitudinal section, 37-mm gun.

(4) *To mount gun on tripod, the gun and tripod being removed from axle.*—Straddle and raise front of the trails. Hold them between the knees. With right hand remove front leg pin from front leg shackle, allowing the front leg to fall. Lock front leg in position by inserting front leg pin in the upper opening in bronze housing and through the front leg. Lower tripod to the ground. Unstrap the trail straps. Spread trails and adjust trail brace by inserting trail-brace tongue in the right trail. Place barrel and cradle on trunnion bearings. Adjust latch housing on elevating screw to elevating screw latch catch bracket, and lock the trunnions. Remove rammer. Close the breech. Uncock the gun.

(5) *To remove wheels from axle.*—Raise or block up end of axle. Pull down on linch pin ring and turn the wheel until the recess in hub is in line with head of the linch pin. Remove linch pin and washer. Lift off the wheel. Replace the washer and linch pin.

(6) *To assemble gun and tripod on wheels, the gun being mounted on tripod.*—Remove gun and cradle from tripod. Disengage trail brace from right trail and place it on the left. Pull down on traversing screw lock ring and close the trails. Strap trails together by means of the trail strap. Straddle and raise front of the trails. Grasp trails between the knees, withdraw front leg pin from pintle socket, and fold back the front leg. Secure front leg in front leg shackle by means of the front leg pin. Insert stud of the pintle socket into pintle socket bearing, hook axle stays, lock axle lock, and insert axle coupling pin into socket stud. Replace gun and cradle on the mount.

b. Mounting.—The operation of remounting may be accomplished by reversing the order of dismounting.

■ 5. **DISASSEMBLING AND ASSEMBLING.**—*a. To remove breechblock and extractor from breech ring.*—Cock the gun. Push extractor pin to the right with a finger of left hand. Remove extractor pin to the right. Press in on breechblock lever release pin cap and remove breechblock lever. Place thumb of right hand in the port of breechblock, and left hand, palm up, under breechblock. Unscrew breechblock by turning it to the left. Lift extractor from its seat.

b. To replace extractor and breechblock in breech ring.—Replace extractor in its seat in breech ring. Cock the gun if it is not already cocked. Screw breechblock into breech ring. Replace breechblock lever. With left hand below breech ring, raise extractor and with right hand return extractor pin from right to left. Uncock the gun.

c. To remove barrel from cradle.—(1) Level barrel by elevating screw. Cock the gun. Open the breech. Uncock the gun. Press up on piston cross head key latch with thumb and index finger of right hand, and remove piston cross head key to the left. Insert rammer through the bore from the breech and remove barrel to rear, being careful that the bronze shoes do not become damaged by allowing the rear end of barrel to bear down. To overcome any possibility of damage to the shoes, it is advisable that two men remove the barrel.

(2) To replace the barrel reverse the order of dismounting, exercising necessary care to insure the sear being returned in proper relative position with trigger crank and safety bolt.

d. To remove striker and striker spring from striker housing.—(1) Depress muzzle of barrel slightly. Remove piston cross head key. Slide barrel to the rear about 7 inches. Push striker to its complete forward position, loosen striker rod nut set screw, and unscrew nut from striker rod. Allow spring to expand slowly and pull out striker and striker spring.

(2) To replace striker and striker spring, reverse the order of dismounting.

e. To disassemble breechblock.—(1) Remove breechblock from breech ring. Remove rocker pin by drawing it toward center of the port. Lift out rocker. Place hand over rocker seat and turn the breechblock over, allowing the rocker plunger, firing pin, and firing-pin spring to drop out.

(2) To assemble the breechblock reverse the order of disassembling.

■ 6. OPERATION.—*a. To cock gun.*—Place palm of the hand against the striker and push it forward quickly until head of sear engages in cocking notch of striker. Cocking by hand is necessary only for the first round.

b. To uncock gun.—Close breech if not already closed. Place palm of left hand against striker, press on trigger

crank lever with thumb of right hand, and allow striker to come back gently.

c. To open breech.—Cock the gun. Rotate breechblock by moving breechblock lever to the left until it meets the shoulder which limits movement of opening.

d. To close breech.—Rotate breechblock by moving breechblock lever to the right until it meets the shoulder which limits movement of closing. The hand must be kept on the breechblock lever until the lever comes in close contact with the shoulder which limits movement of closing in order to avoid any return movement of the breechblock.

e. To load.—Open the breech. Insert a round into chamber by grasping it by the base, placing it in the port in breechblock and pushing it into the chamber with the fingers. Close the breech.

f. To unload.—Open the breech smartly. Opening of the breech causes extraction and ejection of the cartridge case.

SECTION III

CARE AND CLEANING

■ **7. CLEANING.**—*a. Bore, chamber, and breech ring.*—Ordinary cleaning after firing using waste or rags includes the following procedure. Remove breechblock. Thoroughly sluice and sponge bore and chamber with either hot water and issue soap, sal soda solution, hot water alone, or in the absence of these with cold water. Then with dry waste or rags swab bore and chamber until they are perfectly dry and clean. Finally oil parts lightly, making certain that the oil covers all surface of the bore. This cleaning should be done as soon as practicable after firing. If the gun is not to be fired for several days a daily inspection should be made to determine whether further cleaning is necessary. The interior of the breech ring should be cleaned and then wiped with an oily rag. If the gun is to be stored for an appreciable period a heavy grease, such as rust-preventive compound (U. S. Army Spec. No. 2-82B), should be applied as a preservative.

b. Breechblock.—Remove breechblock from breech ring and disassemble it. With a dry rag clean dirt and oil from the block and all parts contained therein. Using light oil, lubri-

cate recesses for firing pin, rocker, and rocker plunger. With an oily rag wipe the breechblock, leaving a thin coating of oil, especially on threads and face of the block.

c. Extractor and sear.—Remove extractor and sear from the gun, and clean and oil by wiping thoroughly, first with a dry and then with an oily rag. Oil recesses for the extractor pin and sear plunger before replacing these parts.

d. Outer surfaces of gun.—Clean the outer surfaces, then dry and wipe all exposed metal parts with a lightly oiled rag. Oil interior of the striker housing. Place a drop of oil in recesses for the striker and the safety bolt.

e. Tripod.—Clean outer surfaces, including mortises of axle stay clamps and the holes through which the traversing screw passes. Oil lightly trunnion bearings, pintle bushing, socket stud, bearings of traversing screw, traversing screw, traversing screw plunger, elevating screw latch housing, elevating screw nut, and elevating screw.

f. Axle and wheels.—Using a sponge, wash with water to remove dirt and other fouling that gathers during transportation. Oil pintle socket bearing lightly. Grease axle spindles at intervals to suit circumstances, insuring that they are properly lubricated at all times.

g. Guides, jacket shoe, and clip shoe.—Remove barrel from cradle. With a cloth wet with dry-cleaning solvent, clean inner surfaces of guides and outer surfaces of shoes, then dry the parts. Grease liberally with a heavy oil and reassemble. This will be necessary only in sandy country or under other unusual circumstances.

■ 8. SPECIAL PRECAUTIONS DURING UNUSUAL CONDITIONS.—*a. Cold weather.*—The gun should be tested frequently by hand manipulation to insure that it is functioning properly.

b. Gas attack.—Lids on ammunition chests should be closed and if practicable a heavy coating of thick oil applied to the bore and working parts of the gun. Directly after gas attack the gun should be thoroughly cleaned, using hot water containing a little soda if obtainable. Ammunition should be wiped with an oily rag and fired as soon as tactical conditions permit. Ammunition that has been subjected to gas action should be inspected very carefully and thoroughly before firing.

■ 9. FILLING RECOIL CYLINDER OF CRADLE.—*a.* The recoil cylinder has a capacity of about 2.75 pints of oil. It must be kept properly filled in accordance with the following instructions, or damage to the gun will probably result. The Ordnance Department will furnish the proper grade of oil for recoil cylinders. The following specification is used: Oil, recoil, heavy, U. S. Army Spec. No. 2-36C. The substitution of any filler other than that issued by the Ordnance Department is prohibited.

b. To fill the recoil cylinder, proceed as follows:

(1) By means of the elevating screw depress the muzzle as far as possible.

(2) Fill oil gun with oil. (Unscrew cap with muzzle attached, draw piston back to its full extent, fill cylinder, screw on cap with nozzle attached, and with nozzle pointing upward push in piston until oil starts to flow in order to force the air out of the oil gun.)

(3) Unscrew filling plug in front end cap of recoil cylinder and screw nozzle end of oil gun into position in its stead.

(4) Unscrew drain plug.

(5) Introduce oil into recoil cylinder by slowly pushing in piston of the oil gun, and continue until the oil escaping through the drain hole (from which the drain plug was removed) no longer carries air bubbles.

(6) Holding a finger over the overflow hole to prevent rapid escape of oil, unscrew oil gun, and allow about 1 spoonful (spoon issued with mess equipment) of oil to escape.

(7) Screw both plugs tightly in place.

■ 10. PRACTICES TO BE AVOIDED IN USE AND OPERATION OF GUN.—

a. Snapping trigger mechanism when chamber is empty.

b. Pressing trigger crank lever, the breech not being completely closed.

c. Rotating or attempting to rotate breechblock, gun being uncocked.

d. Putting a strain on the shoulder guard, either in carrying the gun or by leaning on it while getting into or out of gunner's position on left trail.

e. Putting a strain on elevating handwheel by allowing rear end of cradle to drop, or to rest on it when elevating screw is unlatched from elevating screw latch catch bracket

in removing the gun from the mount. The material of which the handwheel is made is quite brittle and will not stand rough handling.

SECTION IV

FUNCTIONING*

■ 11. ACTION OF TRIGGER AND SEAR IN FIRING.—Downward pressure on the trigger crank lever causes a rearward motion of the trigger crank. The lower arm of the sear is in contact with the trigger crank, hence moves rearward with it. The sear being pivoted near its upper portion, this rearward movement of the lower arm forces the sear head down out of contact with the cocking notch of the striker. This downward movement also compresses the sear spring. Pressure on the trigger crank lever should be released when the gun fires.

■ 12. ACTION OF FIRING MECHANISM.—The firing mechanism consists of the striker spring, striker, rocker plunger, rocker and rocker pin, firing pin, and firing-pin spring. The firing mechanism operates when the striker is released by the sear head. The compressed striker spring drives the striker to the rear about 1 inch where it delivers a sharp blow against the rocker plunger, the force of which is transmitted to the rocker and through the rocker to the firing pin. The firing pin is driven forward compressing the firing-pin spring, and striking and igniting the primer of the cartridge.

■ 13. ACTION OF SAFETY BOLT.—The safety bolt seated in a bracket on the left side of the breech ring engages the lower arm of the sear. The breechblock cap contacts the rear end of the safety bolt and is notched to permit the safety bolt to move to the rear when the breech is completely closed. The firing pin is eccentrically mounted to permit it to be brought in line with the primer of the cartridge only when the breech is completely closed. Therefore, the sear can release the striker to cause discharge *only* when the breech is completely closed.

*The explanation of functioning begins with the gun *supposedly* loaded and cocked.

■ 14. ACTION IN RECOIL.—*a.* Action of the powder gases on the breechblock at the moment of discharge causes the recoil of the united barrel and breechblock, driving them rearward a distance of about 8 inches.

b. The bronze shoes attached to the barrel slide in the steel guides attached to the cradle, compelling proper direction of recoil.

c. The firing-pin spring returns the firing pin, rocker, and rocker plunger to position when the rocker plunger moves to the rear away from the striker.

d. The sear, a recoiling part, moves away from the striker, a nonrecoiling part, permitting the sear head under the action of the sear spring to rise behind the cocking notch of the striker.

e. Recoil is resisted, its speed regulated, and movement stopped by action of the recoil mechanism which is attached to the recoiling parts by the piston cross head key. Two forces resist the movement: The strong counterrecoil spring is compressed, and the movement of the piston head is resisted by the oil in the cradle. The oil follows two courses as it flows to the front of the piston head:

(1) It passes through the hollow portion of the forward end of the piston rod.

(2) It forces the piston valve open against the resistance of the piston-valve spring and flows through the holes in the piston head.

■ 15. ACTION OF COUNTERRECOIL.—*a.* Recoil being stopped, the recoiling parts are instantly moved forward by pressure of the compressed counterrecoil spring against the piston head.

b. The piston valve actuated by the piston-valve spring closes the holes in the piston head just before counterrecoil starts. Therefore the speed of counterrecoil is regulated by the rate at which the oil in the cradle flows through the hollow portion of the forward end of the piston rod.

c. The final movement of the returning parts is gradually stopped and shock to the gun prevented by the action of the counterrecoil buffer which progressively closes the hollow portion of the piston rod through which the oil must flow.

d. As the recoiling parts return to battery the sear carries the striker forward, compresses the striker spring, and automatically cocks the gun. To permit this action to occur the thumb must be removed from the trigger crank lever as the gun fires.

■ 16. **EXTRACTION AND EJECTION OF CARTRIDGE CASE.**—The extractor seated in the breech ring is pivoted near its lower end on the extractor pin. When the breech is opened by rotating the breechblock smartly to the left, the extractor cam on the face of the breechblock strikes the heel of the extractor, depresses it, and causes the upper arm of the extractor to rotate to the rear. The upper arm of the extractor engaged in front of the rim of the cartridge case extracts the empty case and ejects it from the gun.

SECTION V

DEFECTS AND STOPPAGES

■ 17. **DEFECTS AND STOPPAGES.**—Defects and stoppages do not occur with sufficient frequency to warrant a special form of drill in remedying them. They are listed herein for information. Such instruction will be given the soldier in their nature and the action necessary to remedy them as will insure the most efficient operation of the gun.

a. *When breech cannot be opened and inspection discloses that gun is not cocked.*—(1) *Causes.*—(a) Failure to release pressure on trigger crank lever when the gun fires.

(b) Worn or broken sear, or weak sear spring.

(2) *Action to remedy.*—Cock the gun. Caution firer to release pressure on trigger crank lever when the gun fires. If the gun will not cock, replace defective part.

b. *When breech cannot be opened and inspection discloses that gun is cocked.*—(1) *Causes.*—(a) Firing pin is engaged in primer because of a weak or broken firing-pin spring or burred or dirty rocker mechanism.

(b) Piston cross head key has not been inserted fully with the result that the safety bolt is not withdrawn from notch in breechblock cap.

(2) *Action to remedy.*—(a) Withdraw safety bolt from notch in breechblock cap and insert piston cross head key properly.

(b) Tap with some soft object on the protruding part of rocker and work breechblock lever until firing pin comes loose. This failing, insert rammer into bore from muzzle and tap empty cartridge case. If this is not effective, remove rocker and attempt to withdraw firing pin. As a last resort, break off firing pin by forcing the breech open, replace defective parts, and clean and oil rocker mechanism. If the rocker mechanism is burred, smooth carefully with a fine file or emery paper.

c. When gun fails to eject empty cartridge case.—(1) *Causes.*—(a) Failure to open breech smartly.

(b) Defective ammunition.

(c) Broken or worn extractor.

(d) Dirty chamber.

(2) *Action to remedy.*—(a) Close breech and open smartly.

(b) If this is not effective, remove the empty case with the rammer by inserting the rammer through the bore from the muzzle; the hand extractor also may be used to remove rounds or empty cartridge cases from the chamber.

(c) Replace extractor if necessary.

(d) Clean chamber thoroughly.

d. When gun fails to return completely into battery.—(1)

Causes.—(a) Dirty or burred slides or shoes; lack of grease on slides for shoes.

(b) Expansion of oil in recoil cylinder because of overheating.

(c) Weak counterrecoil springs.

(2) *Action to remedy.*—(a) If necessary to continue firing, push the gun forward into battery by hand. When necessity for fire ceases, clean and grease shoes and slides. If burred, smooth them carefully with a fine file or emery paper.

(b) If shoes or slides are not dirty or burred, unscrew filling plug and allow about a spoonful (spoon issued with mess equipment) of oil to escape.

(c) Should the above remedies be ineffective, the gun should be returned to the Ordnance Department for repair.

SECTION VI

INSTRUMENTS AND ACCESSORIES

■ 18. FIELD GLASS, TYPE EE.—*a. Description.*—(1) The field glass, type EE (fig. 5), is an observation instrument of 6-power with an 8° field of view. It contains a graduated mil scale for the measurement of small horizontal and vertical angles. In field glasses of older manufacture an inverted sight leaf scale is also provided for the rapid computation of certain fire data. The field glass complete consists of the glass and its carrying case and neck strap.

(2) The field glass proper consists of two compact prismatic telescopes pivoted about a common hinge which permits adjustment for interpupillary distances. A scale graduated every 2 millimeters from 56 to 74 permits the observer rapidly to set the telescope to suit his eye distance when the spacing of his eyes is known. The eyepiece can be focused independently for each eye by screwing in or out. Each is provided with a diopter scale for rapid setting when the observer knows the correction for his eye. The zero graduations indicate the settings for normal eyes.

(3) The left telescope is fitted with a glass reticle (figs. 6 and 7) upon which are etched a vertical mil scale, a horizontal mil scale, and on field glasses of older manufacture, a stadia scale graduated similar to the sight leaf graduation on the service rifle, but inverted.

b. Use.—The field glass is used for observations and the measurement of small horizontal and vertical angles in mils. The inverted sight leaf, when provided, is used to pick up auxiliary aiming points in direct laying and to determine troop safety for overhead fire.

c. Adjustments.—(1) *Interpupillary distance.*—To adjust the glass so that the eyepieces are the same distance apart as the pupils of the observer's eye, point the glass at the sky and open or close the hinged joint until the field of view ceases to be two overlapping circles and appears to be one sharply defined circle, then note the reading on the scale which indicates the spacing of the observer's eyes. Similar setting of any other field glass will then accommodate his eyes.

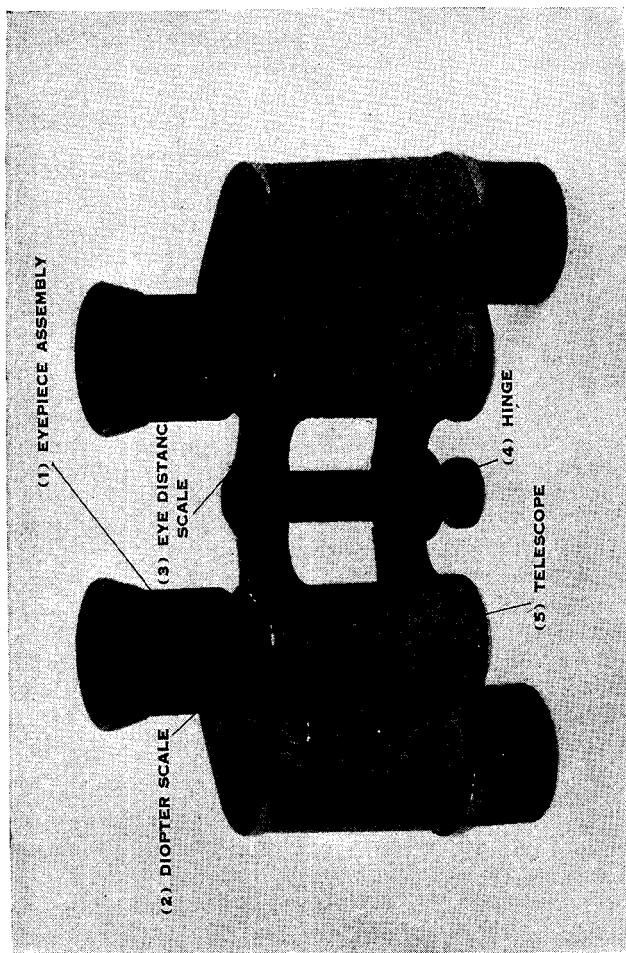

FIGURE 5.—Field glass, type EE.

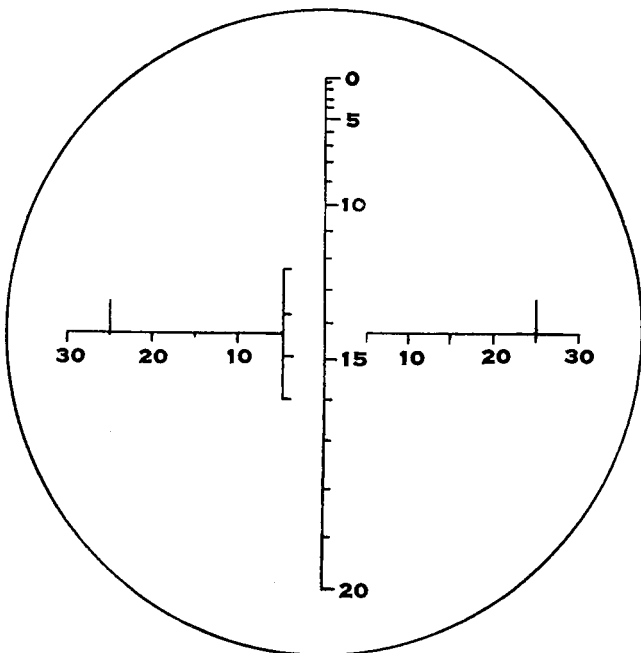

FIGURE 6.—Reticle on field glasses of older manufacture.

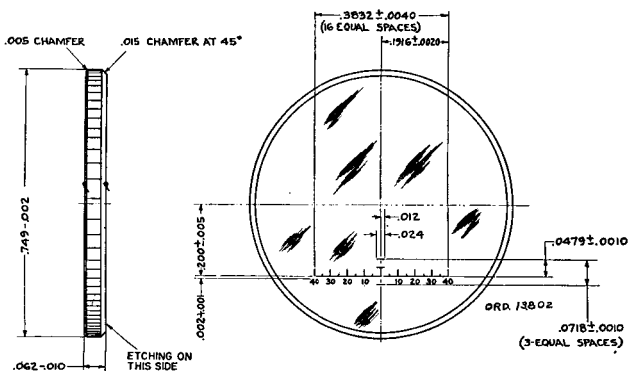

FIGURE 7.—Reticle on field glasses of recent manufacture.

(2) *Focus of eyepieces.*—Look through the glasses, both eyes open, at an object several hundred yards away. Place the hand over the front of one telescope and screw the eyepiece of the other in or out until the object is defined sharply. Repeat this operation for the other eye, then note reading on each diopter scale. Similar reading of any other field glass will accommodate the same eye.

d. Operation.—(1) In using the glass it should be held in both hands, lightly pressed to the eyes so as to keep the relation with the eyes constant but not so as to transmit tremors of the body. The bent thumbs may cover the corners of the eyes to exclude light except that which enters the glass through the lenses. When possible, it is best to use a rest for the glass or to rest the elbows on some solid object.

(2) The mil scales are seen when looking through the glass and by superimposing them on any objects, the horizontal and vertical angles between these objects may be read.

(3) The inverted sight leaf scale is used to secure range settings on sharply defined auxiliary aiming points when the target is not clear enough for direct aiming.

e. Care.—The field glass is a rugged, serviceable instrument but it should not be abused or roughly handled. Care should be taken not to scratch or mar the lenses.

■ 19. LENSATIC COMPASS, MODIFIED PRISMATIC TYPE.—*a. Description.*—This compass is an instrument of unusual flexibility and precision when properly used. It has a pivoted dial needle inclosed in a nonmagnetic metal case with a hinged cover and an eyepiece containing a small magnifying lens. The needle dial has inscribed on it two azimuth circles of 6,400 mils, one with its zero at the north point for use in reading the face of the compass, the other with its zero at the south point for use in reading azimuth through the eyepiece (fig. 8). The least reading of the compass is 20 mils. Owing to the sensitive character of the needle suspension, even this accuracy is difficult to obtain unless the compass rests on a solid support. One outside ring about the base of the compass is graduated into the cardinal points of the compass and another as an azimuth circle. The former is useful for taking bearings and the latter is useful on a map as a protractor and in setting off azimuth by means of the

index on a movable ring about the top. Directions are laid off by means of the index (pointer) on this movable ring. The index on the movable ring, the zero point on the azimuth circle on the dial, and the north point of the needle are marked with radiolite for visibility in the dark. The eyepiece consists of a metal standard supporting a small lens through which azimuth may be read directly from the outer dial circle. Vertically above the aperture of the standard is a narrow slit. Vertically across the glass face of the compass cover is an etched line in the line of collimation of the instrument.

b. Use.—(1) The chief use of the lensatic compass, modified prismatic type, with the gun is the measurement of magnetic azimuths. It may also be used as a marching compass.

(2) If practicable, the compass should be rested on a level surface. However, it can be read accurately when held in the hands, the ring between thumb and forefinger of one hand, the other fingers closed, with thumb and forefinger of the other hand grasping the compass box and the other fingers clasping the other hand, elbows close to the body or resting on the knees, depending on the position of the observer.

(3) The instrument should be held as nearly level as possible to permit the dial to swing free, otherwise errors in the readings will result.

c. Operation of compass.—(1) *To declinate compass.*—(a) Select some point located on the map from which several points can be seen, the grid Y azimuth of which can be determined from the map. Measure the magnetic azimuths (readings from magnetic north) to each of the points and compute the differences between magnetic azimuths as measured by the instrument and the grid Y azimuth taken from the map. The average of these differences will be the declination constant for that particular compass. Record the value of the constant for ready reference. If the compass is to be used in another locality 6 miles or more distant, the declination constant should again be determined for the new locality.

(b) In determining the declination constant it is best to select three points, one of which should be at least 2,000 miles from one of the other points.

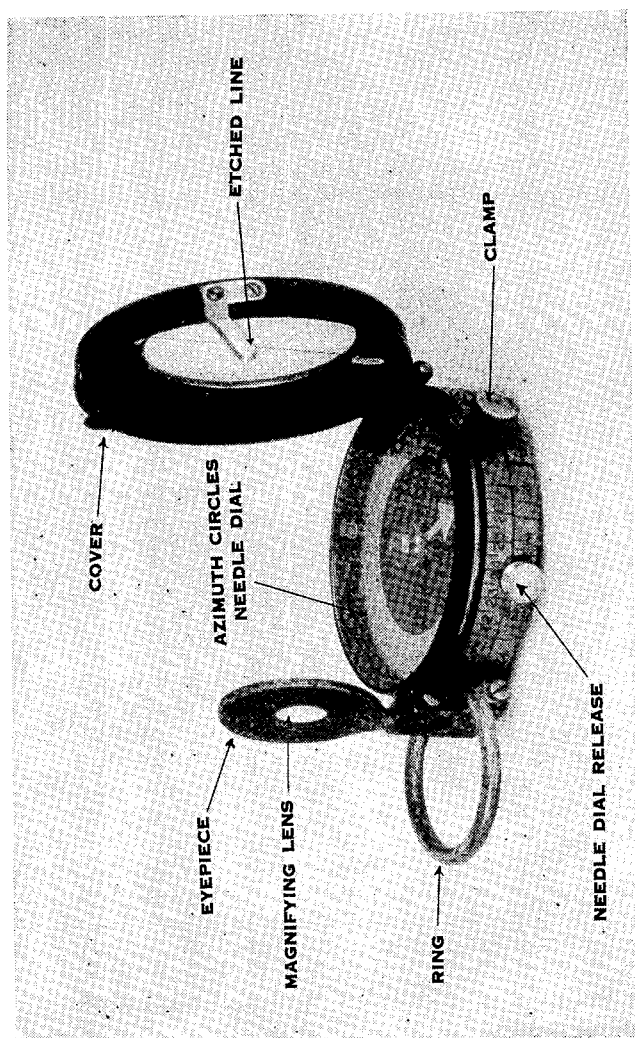

FIGURE 8.—Lensatic compass, modified prismatic type.

(c) If the compass azimuths are greater than the grid azimuths, the declination is west and must be added to grid azimuths to convert to compass azimuth; if less, the declination is east and must be subtracted.

(2) *To measure an azimuth.*—(a) Raise eyepiece and cover vertically and lower needle dial.

(b) Grasp the ring between thumb and forefinger, allowing base of compass to rest on the back of the fingers.

(c) Hold compass horizontally in front of the face, hand against chin, and aperture of eyepiece immediately in front of one eye with the other eye closed.

(d) Turn about carefully until the object whose azimuth is desired is bisected by the etched line on the cover as viewed through the slit of the eyepiece standard. Allow needle to come to rest, then read the azimuth from the outer circle as viewed through the aperture. If greater stability of the needle is desired, the compass should be supported on a solid platform or used in a prone position on the ground.

(3) *To measure an azimuth at night.*—(a) Use the radiolite marker on the movable index ring to lay off the azimuth on the circle about the outside of the compass case. The clamp controls the movable ring.

(b) Hold the compass horizontally and carefully turn about until the needle points to the marker on the movable ring. The azimuth is now indicated by the radiolite marker along the line of sight of the instrument.

(4) *To determine azimuth of position of observer from a given point (target).*—Read azimuth of given point as described above. Since the position of the observer with respect to the given point is on back azimuth determine the back azimuth, that is, if the reading is less than 3,200 mils, add 3,200 to it; if over 3,200 mils, subtract 3,200 mils from it.

(5) *To lay off a line of a given azimuth from position of observer.*—Turn compass until the dial index indicates the given azimuth. Direct the placing of an aiming stake on the line of sighting.

(6) *Given an azimuth to a point, to find a position from which the point is on that azimuth.*—The observer places himself approximately on the required line, aims at the given point, and reads the dial. He then moves to right or left

while aiming at the point until the given azimuth is indicated on the dial. Moving to the right decreases the reading; to the left increases it.

(7) *Given the azimuth from a point, to find a position which is on that azimuth from the given point.*—Determine the back azimuth. The result is the azimuth of the given point from the required position, then proceed as in (6) above to find that position.

(8) *To find the horizontal angle between two points from position of observer.*—Read the azimuth to each point and subtract the smaller reading from the larger. The difference is the required angle.

d. Care and preservation.—The instrument contains a delicately pointed pivot and jewel and must be handled carefully. Care should be taken to prevent damaging the glass cover. No adjustments of the parts in the compass box are permitted within the company.

■ 20. PRISMATIC COMPASS.—This compass is identical in operation and construction with the lensatic compass, modified prismatic type, except—

a. The needle dial of the prismatic compass is graduated in degrees instead of mils.

b. The prismatic compass, as its name indicates, is provided with a prism which magnifies the figures on the needle dial instead of the magnifying lens described above for the lensatic compass.

■ 21. TELESCOPIC SIGHT, M1916, FOR THE 37-MM GUN, M1916.—The telescopic sight, M1916, complete, consists of the sight and its carrying case. It is of the fixed focus, straight telescopic erecting type.

a. Description.—The following parts are shown in figure 9.

(1) Bracket (6) for attaching the sight to the left side of the gun.

(2) Eyepiece (2) which carries the eyelens and is of fixed focus type.

(3) Eyeshield (1) made of soft rubber, the purpose of which is to shut out light between the eye and the eyelens, and to locate the eye at the proper distance from the eyelens.

(4) Sunshade (3) which slips over the front end of the sight to prevent the entrance of the sun's rays to the object lens.

(5) Range dial (5) graduated in 50-yard divisions from zero to 1, and in 25-yard divisions from 2 to 18, and numbered every 100 yards.

(6) Deflection dial (4) graduated into 140 equal spaces, each space representing an angle of 1 mil and numbered

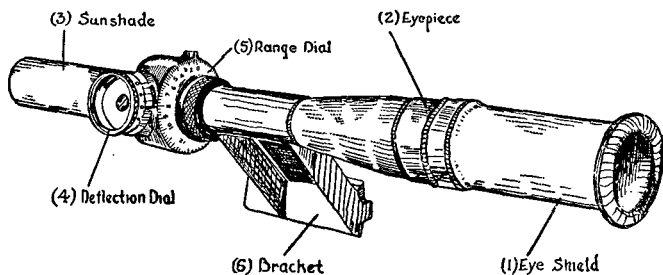

FIGURE 9.—Telescopic sight, M1916, for 37-mm gun, M1916

every 10 spaces from zero to 70 clockwise and counter-clockwise.

b. Use.—The telescopic sight is used for direct laying of the gun.

c. Operation.—When the eye is placed at the eyeshield, cross lines appear in the field of vision. One line is horizontal and the other inclined to the right of vertical $2^{\circ}10'$. The cross lines are commonly known as cross hairs. The horizontal line is controlled by the range dial. Setting a number on the range dial opposite the index on the body of the sight lowers the line of aim through an angle which is equivalent to the angle of elevation required on the gun for firing at the range corresponding to the number opposite the index. The vertical line is controlled by the deflection dial. Turning the zero graduation of the deflection dial upward toward the word "right" stamped on the body of the sight will set off right deflection in mils as indicated by the graduation opposite the index on the body of the sight. Turning the zero graduation downward sets off left deflection.

d. Care and preservation.—(1) The dovetail lug on the bracket should not be damaged, burred, or nicked in such a way as to make the assembling of the sight to the carriage bracket difficult.

(2) Wiping dirt or moisture from the eyelens or objective lens should be done carefully with a soft cloth.

(3) Before inserting the instrument into the carrying case remove both the eyeshield and the sunshade. Place the instrument in the case, with the eyelens downward, and insert the shield in the space at the side of the instrument with the shade inside the shield.

■ 22. QUADRANT SIGHT, M1916, FOR 37-MM GUN, M1916.—The quadrant sight, M1916, complete, consists of the sight and its carrying case.

a. Description.—The following parts are shown in figure 10:

(1) Bracket (2) for attaching the sight to bracket on left side of the gun.

(2) Housing (3) pivoted on the bracket. The housing bearing is inclined $2^{\circ}10'$ which has the effect of turning the sight line through the collimator to the left, automatically correcting for drift for the various ranges when the gun is elevated.

(3) Collimator (5) mounted on top of the housing is pivoted at its forward end and can be rotated horizontally by turning the deflection dial.

(4) Rear lens (4) which magnifies the cross lines on a lens in the front end of the collimator.

(5) Deflection dial (6) graduated into 180 equal spaces, each space representing 1 mil and numbered every 10 spaces from zero to 90 clockwise and counterclockwise. Due to construction the usable range of the dial is limited to 80 mils clockwise and counterclockwise. When the deflection dial is rotated to any desired setting the line of sight through the collimator has been displaced to the right or left through an angle of the value indicated.

(6) Range dial (1) graduated in 25-yard divisions from zero to 1,800 and numbered every 100 yards (final 00 is omitted). This dial is also marked to indicate ammunition and fuze for which it is graduated.

(7) Angle-of-site dial (8) rotates independently of the range scale. A portion of the periphery is graduated into 140 equal spaces, each space representing 1 mil and numbered every 10 spaces from zero to 70 clockwise and counterclockwise.

(8) An index line engraved opposite the zero graduation of the angle-of-site dial in such a manner as to indicate on the outer edge of the range scale.

(9) Level vial (7) for determining the horizontal where indirect laying is used.

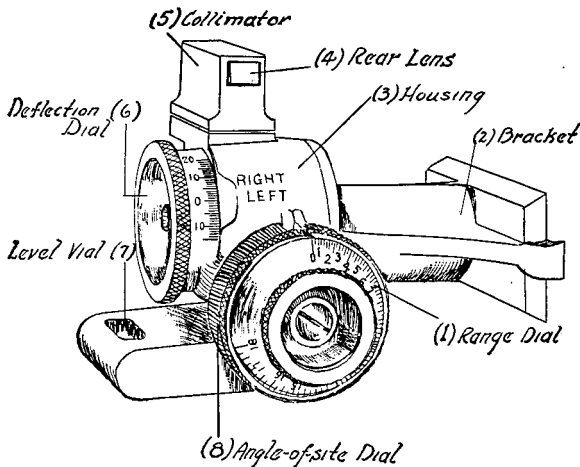

FIGURE 10.—Quadrant sight, M1916, for 37-mm gun, M1916.

b. Use.—The quadrant sight, M1916, is used for aiming the gun in direction by using the collimator and in elevation by using the graduated dials.

c. Operation.—(1) For indirect laying rotate the deflection dial until the graduation corresponding to the desired deflection is opposite the upper index on the housing. Rotate the angle-of-site dial until the graduation corresponding to the angle of site of the target is opposite the lower index on the housing. Rotate the range dial until the graduation corresponding to the desired range setting is opposite the

index or zero on the angle-of-site dial. Bring the level bubble midway between the graduations on the level vial by means of the elevating mechanism of the carriage, and by means of the traversing mechanism traverse the carriage until the vertical line in the collimator is laid on the aiming point. Check and recenter the bubble if necessary.

(2) For direct laying set the deflection dial at the desired setting, the angle-of-site dial at zero, and rotate the range dial until the desired range is opposite the index on the angle-of-site dial. By means of the elevating and traversing mechanism of the carriage bring both of the collimator cross lines on the aiming point.

d. To use collimator.—Hold the eye approximately 10 inches in rear of the rear lens. Move the head vertically or horizontally until the eye views the cross and the target in coincidence, first in elevation and then in azimuth. It may be more convenient for some men to sight with both eyes open.

e. To adjust range scale.—Level the gun by using a clinometer and rotate the range dial until the level bubble is midway between the index lines on the level vial. Set the angle-of-site dial at zero. Loosen the range dial securing screw and rotate the range dial until the zero coincides with the index, then tighten the screw. If the bubble has not been displaced from its previous setting during this operation, the sight is in adjustment for range. No means are provided for adjusting the deflection scale in the field.

f. Care and preservation.—The dovetail lug on the bracket should not be damaged, burred, or nicked in such a way as to make the assembling of the sight to the carriage bracket difficult.

■ 23. ACCESSORIES.—*a.* The accessories for the gun are listed in Standard Nomenclature List No. A-7. The principal accessories used by the gun crew consist of—

(1) *Accessory and spare-parts case* made of russet strap leather with a buckled cover and fitted straps for fastening to the gun carriage.

(2) *Ammunition chest* made of wood having a hinged cover and spring latch. It holds 16 rounds.

(3) *Cleaning brush and rammer.*—The cleaning brush consists mainly of a block of wood cylindrical in shape with

bristles attached lengthwise about the front outer surface. The rammer which serves as a handle for the cleaning brush is also used to remove a shell from the bore.

(4) *Drag rope with shoulder strap* used to move the gun into position by hand.

(5) *Flash hider*, a long metal cone which clamps to the muzzle end of the barrel to cover the flash.

(6) *Gun cover* made of olive-drab duck and provided with leather straps for fastening on the gun.

b. Other accessories.—Hand cartridge extractor, oiler, recoil cylinder dismounting wrench, recoil cylinder filling oil gun, and tool roll. Their use is implied by their names.

SECTION VII

AMMUNITION

■ 24. **GENERAL.**—The information in this section pertaining to the several types of fixed complete rounds authorized for use in the 37-mm gun, M1916, includes a description of the rounds, means of identification, care, use, and ballistic data.

■ 25. **CLASSIFICATION.**—*a.* Based upon use, the principal classifications of ammunition for this gun are—

(1) High explosive (HE), for use against personnel and light matériel targets.

(2) Low explosive (LE), for use against personnel and light matériel targets, also for artillery subcaliber practice.

b. Other types provided for special purposes are—

(1) Blank, for simulated fire and salutes.

(2) Drill, for training (complete round is inert).

■ 26. **AMMUNITION LOT NUMBER.**—When ammunition is manufactured, an ammunition lot number which becomes an essential part of the marking is assigned in accordance with pertinent specifications. This ammunition lot number is stamped or marked on every loaded complete round, on all packing containers, and on the accompanying ammunition data card. It is required for all purposes of record, including reports on condition, functioning, and accidents, in which the ammunition might be involved.

■ 27. IDENTIFICATION.—*a. Markings on packing boxes.*—The contents of original packing boxes are identified readily by the markings on the box. Additional data pertaining to the rounds contained therein are included on the ammunition data card packed with the rounds in each box.

b. Color of projectiles.—All projectiles are painted to prevent rust and by means of the color to provide a ready method for identification as to type. The color scheme is as follows:

(1) High explosive projectiles, yellow.

(2) Low explosive projectiles (black powder filler), red.

(3) Practice projectiles, blue. These may contain only a sand filler with an inert fuze, or they may contain a live fuze with a spotting charge of black powder.

c. Markings on round.—The complete round removed from its packing box is identified completely by the following information stamped or stenciled thereon:

(1) Caliber and type of cannon in which fired.

(2) Mark or model of projectile.

(3) One diametral stripe on the base of the cartridge case indicates normal charge.

(4) Ammunition lot number.

■ 28. CARE, HANDLING, AND PRESERVATION.—*a. Ammunition is made and packed to withstand all conditions ordinarily encountered in the field. Nevertheless, since explosives are adversely affected by moisture and high temperature, due consideration will be given to protect the ammunition therefrom.*

b. Both high and low explosive ammunition, being fuzed, will be handled with care at all times.

c. Carefully protect the ammunition from mud, sand, dirt, and water. If it gets wet or dirty, wipe it off at once. The complete round should be free of foreign matter (sand, mud, grease, etc.) before loading into the gun.

d. Do not allow the ammunition to be exposed to the direct rays of the sun for any length of time. This is liable to affect seriously its firing qualities.

e. Do not fire rounds which have seriously damaged cartridge cases or which are otherwise defective.

f. Protect the ammunition from blows against the primer.

■ 29. STORAGE.—Whenever practicable, ammunition will be stored under cover. If it is necessary to leave the ammunition in the open, it will be raised on dunnage at least 6 inches from the ground and the pile covered with a double thickness of paulin. Suitable trenches will be dug to prevent water from flowing under the pile.

■ 30. AUTHORIZED ROUNDS.—*a.* The ammunition authorized for use in the 37-mm gun, M1916, is listed below. It will be noted that the designation completely identifies the ammunition as to type and model as well as the caliber and model of gun in which the round is fired. Complete rounds with explosive projectiles for this gun are issued and shipped with base fuzes fitted to the projectiles.

Ammunition for 37-mm gun, M1916	Approximate weight of complete round (pounds)
<i>Service ammunition</i>	
Shell, fixed, HE, Mk. II, 37-mm gun, M1916 (with BDF M38)	1.57
Shell, fixed, HE, Mk. II, 37-mm gun, M1916 (with BDF Mk. IV) ..	1.57
Shell, fixed (LE), Mk. I, 37-mm gun, M1916	1.44
<i>Blank ammunition</i>	
Ammunition, blank, 37-mm gun, M191653
<i>Drill ammunition</i>	
Cartridge, drill, M5, 37-mm gun, M1916	1.32

b. The high explosive shell, Mk. II, is slightly longer, heavier, and contains more explosive than the low explosive shell, Mk. I.

■ 31. DATA.—The firing tables applicable are 37-A-2 and 37-A-2, Abridged. Data abstracted therefrom are contained in paragraphs 83*a* and 98.

CHAPTER 2

DRILL FOR PLACING GUN IN ACTION

■ 32. OBJECT AND SCOPE.—*a.* The object of gun drill is to give the squad complete confidence in its ability as a team to put its gun into action with precision and speed.

b. Teamwork is assured by a rotation in duties during drill so that each member by practice becomes acquainted expertly with the duties of every other member.

c. Precision is attained by strict adherence to the prescribed procedure. Exactness is the first objective. When it has been developed, speed is emphasized.

■ 33. GENERAL RULES.—*a. Equipment required.*—Articles of equipment required for gun drill are—

- 1 37-mm gun on wheels (trails for pack units).
- 1 telescopic sight.
- 1 quadrant sight.
- 4 boxes ammunition.
- 2 aiming stakes.
- 4 dummy cartridges.
- 1 pair field glasses.
- 1 compass.
- 1 set fire-control tables.
- 5 carrying slings.

If drill is to be conducted over rough ground two breast straps should be included.

b. When the gun is drawn on wheels the equipment is transported as follows:

Squad leader.—Carries field glass, compass, and fire-control tables.

No. 1 (gunner).—Carries sights and aiming stakes.

Nos. 2 and 3.—Carry two boxes of ammunition each.

No. 4.—No load assigned. Assists as directed.

Nos. 5 and 6.—Draw the gun.

No. 7.—Assists as directed.

When the gun is drawn by hand over rough ground one or more members of the squad may assist in drawing it by breast

straps. Ordinarily breast straps are carried in the cart. In the field or in training for field duties all members who carry ammunition boxes or ammunition and parts of the gun are equipped with carrying slings. Ordinarily the carrying slings are carried in the carts with the breast straps.

c. When the gun is carried by hand the equipment is transported as follows:

Squad leader.—Carries field glass, compass, and fire-control tables.

No. 1 (gunner).—Carries sights and aiming stakes.

Nos. 2 and 3.—Carry assembled barrel and recoil cylinder, muzzle to the front, and one box of ammunition each.

No. 4.—Pushes the wheels and axle, if present, or carries ammunition.

Nos. 5 and 6.—Carry trails, pintle leading, and one box of ammunition each.

No. 7.—Assists as directed.

d. During dismounting and mounting only those members who are actively engaged in a phase of dismounting or mounting will be at the gun position. Those members who have dismounted or mounted a part of the gun will move clear of the gun position and hold themselves in readiness for the next formation or movement. Those members who are to dismount or mount a part of the gun will be ready to move immediately to the gun position to execute their mission when the gun position has been cleared by the preceding group.

■ 34. To SECURE EQUIPMENT TO PUT GUN INTO ACTION.—a. Normally equipment for gun drill is secured before the squad is formed.

b. In drill the command is: SECURE EQUIPMENT FOR GUN DRILL. At this command the men fall out and each secures the equipment described in paragraph 33. In the field the command is: OFF TRUCKS (PACKS).

■ 35. To FORM CREW (SQUAD) WITH EQUIPMENT.—a. *Squad column* (gun on wheels).—When the gun is drawn on wheels the squad is formed in squad column by the command: 1. SQUAD COLUMN, 2. MARCH. At the command MARCH the members of the squad follow the squad leader at easy marching distance in the following order:

Nos. 5 and 6.

No. 2.

No. 3.

No. 4.

No. 7.

No. 1 (gunner).

Loads are grounded when the squad is halted and taken up at the preparatory command for a movement.

b. Squad column (by hand).—When the gun is carried by hand the movement is the same except that the men follow the squad leader in the squad column in the following order:

No. 5.

No. 6.

No. 2.

No. 3.

No. 4.

No. 7.

No. 1 (gunner).

■ 36. TO CHANGE NUMBERS AND DUTIES DURING DRILL.—*a.* The squad being in any formation the command is: **FALL OUT ONE, TWO** (or any other number in the squad). At this command No. 1 (gunner) takes the position of the last number of the squad. No. 2 calls out "One," and moves to the position of No. 1 (gunner). No. 3 calls out "Two," and moves to the position of No. 2, and in this manner throughout the squad, each man moves up one number. When a number other than No. 1 (gunner) is directed to fall out, he takes the position of the last number of the squad. The numbers following the designated number call out their new number and move to their new positions. The men preceding the designated number do not change their positions.

b. This rotation in drill is made in order to train all members of the squad in the duties of the other members *and to simulate casualties*. During the earlier stages of gun drill this command is given only after a movement or command has been completely executed. After each member of the squad is familiar with the duties of every other member the command may be given before the completion of a movement. In such cases each man at once stays the execution of his duties and takes up the duties of his new number.

■ 37. TO EXAMINE GUN EQUIPMENT.—*a.* The equipment being grounded the corporal commands: **EXAMINE EQUIPMENT BEFORE FIRING.** At this command each man, keeping well down, examines the equipment constituting his load as indicated below and reports to the corporal, naming the deficiencies, if any, which he cannot correct. The same procedure is followed in both drill and combat except that in drill, water, oil, and ball ammunition are assumed.

(1) The equipment being laid out to be transported by hand, No. 1 (gunner) examines the sights and sees that they are clean, that all movable parts work easily, and that the scales are set at zero.

(2) No. 2 examines the gun and sees that—

(*a*) Muzzle is pointed to the front.

(*b*) Barrel is clear.

(*c*) Filling plug and drain plug are screwed in.

(*d*) Firing mechanism is cocked.

(*e*) Sight clamp is loosened.

(*f*) Breech is open and breech lock free to rotate.

(*g*) Trigger is free.

(*h*) Barrel is completely returned to battery.

(*i*) All movable parts are clean and lightly oiled.

(3) No. 4 examines wheels and axles (if present) and sees that this assembly is cleaned and greased properly.

(4) No. 5 examines trails and sees that—

(*a*) Trails are closely folded.

(*b*) Traverse screw nut is at midpoint of the traversing screw and the flat side is against the right trail.

(*c*) Trunnion bearing wing nuts are completely rotated to the forward position.

(*d*) Elevation screw handwheel clears top of trails by 1 inch.

(5) No. 6 examines the ammunition box and sees that—

(*a*) Cartridges and packing strip are clean and dry.

(*b*) Cartridges are inserted in packing strip, points down.

(*c*) Cover of the box is latched.

b. Upon completing this examination of equipment, No. 6 reports, "Ammunition correct" (or the deficiencies); No. 5 reports, "Trails and ammunition correct" (or the deficiencies); No. 4 reports, "Wheels (if applicable), trails, and am-

munition correct" (or the deficiencies); No. 2 reports, "Gun, wheels (if applicable), trails, and ammunition correct" (or the deficiencies); and No. 1 (gunner) reports, "All correct" (or the deficiencies which cannot be corrected).

c. A thorough examination of the gun equipment is made at the beginning and at the end of each drill period. The initial inspection must insure that the ammunition belt is free of live rounds. Upon a change of numbers such examination of the equipment without report is made as will determine that it is in proper condition for execution of the drill.

■ 38. TO DISMOUNT GUN AND FORM SQUAD COLUMN.—*a.* The squad being in squad column and the gun on wheels the command is: **BY HAND.**

(1) If marching, the squad halts.

(2) Nos. 5 and 6 turn the gun to right-about with the left wheel as a pivot until the muzzle points directly to the front and then ground the spades. No. 6 withdraws sponge staff from lunette swivels and hands it to No. 3.

(3) Nos. 2 and 3 each drop one box of ammunition 1 pace to left of center of trails and retain the other box. No. 3 opens breech, inserts sponge staff through the bore, supports breech by means of the sponge staff, and releases elevating screw clutch from clutch bracket. No. 2 from a position near the muzzle unlocks trunnion bearings, grasps protruding end of sponge staff, and assisted by No. 3 lifts barrel and recoil cylinder over the left wheel.

(4) No. 5 straddles trails, unhooks axle stays, and raises front of trails slightly.

(5) No. 4 takes out axle coupling pin, removes axle and wheels, and withdraws them 2 paces to the right so as to prevent interference with forward movement of Nos. 5 and 6.

(6) As soon as axle and wheels have been removed, members of the squad secure their loads. Nos. 5 and 6 take the ammunition dropped by Nos. 2 and 3. For the purpose of uniformity in drill trails will be carried on right hips with top of trails against the body. In the field, however, to avoid undue fatigue trails may be shifted by Nos. 5 and 6 to suit their convenience. The squad forms in squad column as described in paragraph 27.

b. The squad being in position either of PREPARE FOR ACTION or ON WHEELS, ACTION, the command is: BY HAND.

(1) Nos. 2 and 3 dispose of four boxes of ammunition as described in *a* (3) above.

(2) No. 1 (gunner) removes shoulder guard and passes it to No. 2. He then removes the sight, returning it to its case and secures the aiming stakes.

(3) No. 2 replaces shoulder guard on right trail and proceeds as in *a* (3) above.

(4) No. 3 (opens breech if not open) places trigger thumb-piece in carrying position and proceeds as in *a* (3) above.

(5) No. 5 straddles trails and releases traversing screw plunger while No. 6 closes trails and fastens trail strap. No. 5 continuing to straddle trails unhooks axle stays and raises front of trails slightly.

(6) No. 4 takes out axle coupling pin, removes axle and wheels, and withdraws them 2 paces to the right in order to prevent interference with forward movement of Nos. 5 and 6.

(7) Movement is completed as in *a* (6) above.

■ 39. TO MOUNT GUN ON WHEELS AND FORM SQUAD COLUMN.—The squad being in squad column and the gun carried by hand the command is: ON WHEELS.

a. If marching, the squad halts.

b. No. 6 lowers trail spades to the ground. No. 5 lowers and straddles pintle end of trails. No. 4 rapidly brings up axle and wheels. No. 5 inserts socket stud in axle bearing and hooks axle stays. No. 4 inserts axle coupling pin and locks axle lock.

c. Nos. 2 and 3 replace barrel and recoil cylinder on the trunnion bearings which are locked by No. 2. No. 3 fastens elevating screw clutch, withdraws sponge staff from the bore and passes it to No. 6 who inserts it through the lunette swivels. No. 3 closes breech, uncocks the gun, and puts the trigger thumb-piece in carrying position.

d. All members secure their loads and form squad column as described in paragraph 35.

■ 40. TO PREPARE FOR ACTION.—The squad being in squad column and the gun on wheels, to prepare for action the command is: PREPARE FOR ACTION.

a. If marching, the squad halts.

b. Nos. 5 and 6 turn the gun to right-about with the left wheel as a pivot until the muzzle points directly to the front and then ground the spades. No. 5 goes to the front of the gun and unlocks axle lock.

c. No. 6 withdraws sponge staff from lunette swivels, places it on the ground beneath axle, unfastens trail strap, opens trails and adjusts transom.

d. No. 2 places his ammunition boxes between trails in rear of transom, takes shoulder guard from right trail, passes it to the gunner, releases trigger thumbpiece from carrying position, opens breech, and inspects the bore.

e. No. 1 (gunner) places aiming stakes, pointed ends to the left, under transom, attaches shoulder guard and sight to the gun, and tests elevating and traversing mechanisms.

f. Any deficiencies noted by members of the squad are reported to No. 1 (gunner).

g. Members of the squad then take posts as follows:

(1) *Squad leader*, facing to the front, 2 paces to left of and on line with muzzle.

(2) *No. 1 (gunner)*, 2 paces to left of, on line with, and facing the breech.

(3) *No. 2*, 2 paces to right of, on line with, and facing the breech.

(4) *Nos. 3, 4, 5, 6, and 7* form from right to left, facing to the front, 2 paces in rear of trails.

h. No. 3 places his ammunition boxes on the ground, the rear of each box on line with and touching his toes.

i. As soon as the squad is posted, No. 1 (gunner) reports, "All correct" (or the deficiencies noted).

■ 41. TO PUT GUN INTO ACTION.—The gun may go into action either on wheels or on tripod. In action should conditions demand a short, rapid change of position, the gun may be moved without dismounting by the most expeditious means.

a. At the command: 1. ON WHEELS (ON TRIPOD), 2. ACTION, the squad leader indicates the gun position to No. 1 (gunner), obtains firing data and any other information necessary. For indirect laying No. 4 will accompany the squad leader in order to drive aiming stakes when necessary; after the stakes are driven, he will then take his post in rear of the gun. The

squad leader transmits the firing data to the squad and takes a position from which he can observe, direct, and control the fire. For drill purposes No. 1 (gunner) places the telescopic sight on the gun unless the squad leader designates otherwise. As soon as No. 1 (gunner) has received the fire order, he adjusts the sight and lays on the aiming point indicated. At the announcement of **ONE ROUND** by the squad leader, No. 2 loads. The gunner having completed the laying, commands: **FIRE**. At this command No. 2 fires or simulates firing of the gun.

b. The squad being in squad column and the gun on wheels, to form for action on wheels the command is: 1. **ON WHEELS**, 2. **ACTION**. The squad executes **PREPARE FOR ACTION**, except that No. 1 (gunner) and No. 2 take firing positions (which are prone) on the left and right trails, respectively. For drill purposes all other members of the squad take a prone position 5 paces in rear of trails. No. 3 places his ammunition boxes by his side.

c. The squad being in squad column and the gun on wheels, to form for action on tripod the command is: 1. **ON TRIPOD**, 2. **ACTION**.

(1) If marching, the squad halts.

(2) Nos. 5 and 6 turn the gun (par. 38a (2)).

(3) Nos. 2 and 3 remove barrel and recoil cylinder to the left (par. 38a (3)).

(4) Nos. 4 and 5 remove axle and wheels from the mount (par. 38a (4) and (5)). No. 4 moves axle and wheels to a position in rear of the gun. For drill purposes the wheels are moved 8 paces in rear and 1 pace to the right of the right spade. No. 5 straddles trails, grasps them between his knees, and adjusts the front leg while No. 6 unfastens trail strap, open trails, and adjusts transom.

(5) Nos. 2 and 3 replace barrel and recoil cylinder on trunnion bearings which are locked by No. 2. No. 3 fastens elevating screw clutch, withdraws sponge staff from bore, places it on the ground under the gun, and releases trigger thumb-piece. No. 2 places his ammunition boxes between trails in rear of transom, takes shoulder guard from right trail and hands it to No. 1 (gunner), takes his firing position on the right trail, and inspects the bore.

(6) No. 1 (gunner) places aiming stakes, pointed ends to the left, under the transom, attaches shoulder guard and sight to the gun, and tests elevating and traversing mechanisms.

(7) Movement is completed as in *b* above.

d. The squad being in squad column and the gun carried by hand, to form for action on tripod the command is: 1. ON TRIPOD, 2. ACTION. This movement is executed as in *c* above except that the functions of No. 4 regarding the removal of wheels are not applicable, and Nos. 5 and 6 place their ammunition boxes between trails in rear of transom. No. 3 secures the ammunition box carried by No. 2 and takes his post in rear of trails.

e. The squad being in squad column and the gun carried by hand, to form for action on wheels the command is: 1. ON WHEELS, 2. ACTION.

(1) If marching, the squad halts.

(2) Nos. 4, 5, and 6 assemble trails and wheels as described in paragraph 39*b* except that No. 4 does not lock axle lock. Nos. 5 and 6 place their ammunition boxes between trails in rear of transom.

(3) Nos. 2 and 3 replace barrel and recoil cylinder as in *c* (5) above, except that No. 3 secures the box carried by No. 1 and then takes post in rear of trails.

(4) Movement is completed as in *c* (6) and (7) above.

■ 42. TO TAKE GUN OUT OF ACTION.—*a.* The squad being either in position of PREPARE FOR ACTION or ON WHEELS, ACTION, to go OUT OF ACTION the command is: OUT OF ACTION.

(1) Shoulder guard and sight are secured (par. 38*b* (2) and (3)).

(2) No. 2 closes breech, uncocks the gun, and puts trigger thumbpiece in carrying position.

(3) No. 5 locks axle lock and releases traversing screw plunger while No. 6 closes trails, fastens trail strap, and passes sponge staff through lunette swivels.

(4) The squad forms in squad column unless otherwise directed by the squad leader.

b. The squad being in position of ON TRIPOD ACTION, to go OUT OF ACTION with the gun mounted on wheels the command is: 1. ON WHEELS, 2. OUT OF ACTION.

(1) Shoulder guard and sight are secured (par. 38b (2) and (3)).

(2) Nos. 2 and 3 remove barrel and recoil cylinder to the left (par. 38b (3)).

(3) Nos. 5 and 6 secure trails as in *a* (3) above, except that No. 5 does not lock axle lock.

(4) Nos. 4 and 5 assemble trails and wheels (par. 39b).

(5) Nos. 2 and 3 mount barrel and recoil cylinder on trunnion bearings (par. 39c).

(6) The squad forms in squad column unless otherwise directed by the squad leader.

c. The squad being in position of ON TRIPOD ACTION, to go OUT OF ACTION with the gun carried by hand the command is: 1. BY HAND, 2. OUT OF ACTION.

(1) Nos. 2 and 3 dispose of four boxes of ammunition (par. 38a (3)).

(2) Shoulder guard and sight are secured (par. 38b (2) and (3)).

(3) Nos. 2 and 3 remove barrel and recoil cylinder (par. 38b (3) and (4)).

(4) No. 5 straddles trails and releases traversing screw plunger while No. 6 closes trails and fastens trail strap. No. 5 continuing to straddle trails raises the pintle end slightly and grasps the trails between his legs. He then secures the front leg in the front leg shackle.

(5) The squad forms in squad column as described in paragraph 35.

d. The squad being in position of ON TRIPOD ACTION where considerations of cover require the personnel to move by crawling, the corporal commands: 1. DRAG GUN, 2. FOLLOW ME (TO THAT BUSH). At this command the gun is unloaded and pivoted by No. 1 (gunner) and No. 2 about the front spade until the muzzle points to the rear, after the ammunition box is passed back to the rear. No. 1 (gunner) and No. 2 assisted by No. 3 if necessary drag the mounted gun. They follow the route chosen by the corporal or move to the objective designated.

e. The squad being in position of ON TRIPOD ACTION, to move the gun quickly for a short distance the corporal commands: 1. THREE-MAN LOAD, 2. FOLLOW ME (TO SUCH-

AND-SUCH POSITION). At this command the gun is unloaded and the ammunition box is passed to the rear. The gun is carried by Nos. 1 (gunner), 2, and 3, muzzle to the front. No. 1 (gunner) is on the left and grasps the barrel just in rear of the muzzle with his right (left, if gun is to be carried to the rear) hand, back of the hand out. No. 2 is on the right and grasps the barrel just in rear of No. 1's (gunner) hand with his left (right) hand, back out. No. 3 secures trails, backs of both hands out. After the loads have been secured, No. 1 (gunner) calls "Up." The men spring up and carry the equipment, moving rapidly in the trace of the corporal or to the objective designated.

CHAPTER 3

MARKSMANSHIP

	Paragraphs
SECTION I. Preliminary instruction.....	43-54
II. Examination.....	55-60
III. Qualification course, gunner's test.....	61-73
IV. Qualification course, expert's test.....	74-78
V. Targets, ranges, and safety precautions....	79-80

SECTION I

PRELIMINARY INSTRUCTION

■ 43. **GENERAL.**—The purpose of preliminary instruction with the gun is to train personnel to deliver prompt and accurate fire at the command of the gun commander and to train gun commanders to direct placing of quick and effective fire on a target. The final measure of the effectiveness of the gun in battle is its ability to destroy the targets assigned to it in a minimum of time. Before taking instructions in 37-mm gun marksmanship the soldier should be instructed thoroughly in the gun drill of the gun squad as described in chapter 2, and in stripping, mechanism, care, and cleaning of the gun as in chapter 1. He is then taught the mechanical operations to be employed in firing the gun. He is taught these operations in their proper order and must be coached carefully. The instructional exercises to be taken prior to qualification tests are prescribed below. They are taken up in the order given and each man must be proficient in one exercise before proceeding to the next. If time is available, each exercise should be repeated a number of times for the purpose of increasing the soldier's proficiency in it. The progress made by each man in the exercises hereinafter prescribed may be kept on record in the company on the progress chart shown below. During the instruction in duties of individuals in the service of the piece special emphasis is placed upon the necessity for accuracy. The soldier is made to understand thoroughly that speed is purely

PROGRESS CHART

Names	Direct laying 37-mm gun sighting triangles	Direct laying 37-mm gun on target	Direct laying 37-mm gun change in fire data	Direct laying 37-mm gun on aiming point	Indirect laying 37-mm gun with first fire data	Indirect laying 37-mm gun change in fire data	Indirect laying 37-mm gun determining minimum range	Indirect laying 37-mm gun with the compass

METHOD OF MARKING

Fair	X	Good	X X	Very good	X X X	Excellent	X X X	Excellent and has instructional ability	X X X

a matter of practice, but that accuracy can be obtained only by forming the habit of exactness from the beginning. Rapidity is increased by insisting that each individual perform his duties in the prescribed sequence.

■ 44. DUTIES OF No. 2.—*a.* No. 2 is instructed that during firing he takes position on the right trail of the piece and assists the gunner by loading, firing, and unloading the piece. Before being instructed in the technical duties of the No. 1 (gunner) the soldier is taught to perform properly the duties of No. 2.

b. No. 2 is taught to be on his right side with his hip resting on the right end of the trail brace and his right forearm resting on the trail. In all drills and practice he is required to lie as close to the trail as possible so as to form the habit of doing so. By lying close to the trail he presents a small target and lessens the possibility of being observed by the enemy.

c. To load the piece No. 2 is instructed to open the breech, grasp the cartridge by the rim with his left hand, insert the nose into the chamber, and push it in with the first two fingers. He then closes the breech by placing the fingers of his left hand upon the breechblock lever and moving it to the right and down. The fingers do not grasp the breechblock lever but remain upon it until it meets the shoulder which limits the movement of closing. The fingers are then allowed to slide off the breechblock lever, thus preventing it from rebounding when it strikes the shoulder and insuring that the breech is fully closed. A simple demonstration will make it clear that the piece cannot be fired unless the breech is completely closed. An empty cartridge case fitted with a pointed wooden projectile or an empty cartridge case crimped in at the top can be used to advantage in training men to load and unload rapidly.

d. No. 2 is taught to fire the piece by exerting steady pressure upon the trigger with the thumb of his right hand, at the same time steadying himself by resting his right forearm and hand on the trail. As soon as the piece is fired his thumb is allowed to slide off the trigger. Unless this is done the trigger crank will intercept the forward movement of the sear arm in counterrecoil, causing the sear head to be de-

pressed and thus preventing the automatic cocking of the piece. It should be impressed upon the soldier being trained as No. 2 that he fires the piece only at the command of the gunner. During the interval between rounds No. 2 keeps his thumb just above but not touching the trigger to prevent an accidental discharge which might result in injury to the gunner. As soon as the command to fire is given by the gunner the piece will be fired immediately. Both No. 2 and the gunner remain steady on the trail and both remain motionless just before firing, as any movement at this time will decrease the accuracy of fire.

e. To unload No. 2 is taught to open the breech with his left hand, placing his fingers under the breechblock lever and giving it a quick jerk upward and to the left with sufficient force to throw the empty case clear of the gun. His fingers do not grasp the breechblock lever because this would slow up the movement and might cause the gunner who has his eye to the sight to be struck in the head by No. 2's hand.

■ 45. DUTIES OF NO. 1 (GUNNER).—The gunner is instructed that during firing he takes position on the left trail and lays the piece in accordance with firing data received from the observer. In addition to being familiar with the details of laying for direct and indirect laying, the gunner should understand the use and proper selection of aiming points, be able to determine the least range at which the piece may be fired and clear the mask, understand the practical methods of safely employing fire over friendly troops, and understand the proper manner of laying on a moving target on the ground.

■ 46. TRAINING OF NO. 1 (GUNNER); POSITION AT GUN.—The gunner is taught to lie on his left side with his left hip resting on the left end of the trail brace and his left forearm resting on the trail. In laying the piece he grasps the elevating handwheel with his left hand and the traversing handwheel with his right hand. He keeps this hold when the piece is fired in order to maintain the proper laying and prevent undue displacement from the shock of recoil. This precaution also reduces the time necessary to re-lay for direction and elevation. While the gunner is being trained to lay he is not at first required to hold his eye close to the sight during firing. By keeping his eye a few inches in rear of the sight at first the

gunner will be able to eliminate a natural tendency to flinch when the piece is fired, and with a little practice will become accustomed to remaining entirely motionless on the trail during firing. A gunner who flinches is very apt to move the elevating and traversing handwheels and to jar the mount. The gunner soon becomes accustomed to the explosion and the recoil of the gun, and gradually learns to hold his eye nearer to the sight until he finally discovers that position for his eye which secures accuracy, speed, and safety.

■ 47. TRAINING IN DIRECT LAYING.—The telescopic sight is set for range and deflection in the manner described in paragraph 21c.

a. Sight-setting exercises.—In his first instruction in the setting of the telescopic sight the gunner is given the sight to hold in his hand. He sets off ranges and deflections commanded by the instructor who checks each setting before commanding the next. The sight is then placed on the gun and further practice is given the gunner in setting off range and deflection.

b. Aiming with telescopic sight.—Accurate shooting cannot be done unless the cross lines are laid on exactly the same point for all shots. The better defined this aiming point is the easier it is for the gunner to rely on the same point. During a soldier's first instruction in aiming he is taught to aim at clearly defined points. To this end a small paster about 2 inches square is placed on a screen about 25 yards in front of the gun. The instructor lays the gun by aiming at the paster. In aiming at the paster the intersection of the cross lines is laid upon one corner of the paster in such a manner that two sides of the paster coincide with the cross lines in one quadrant of the field of the telescope. The instructor explains that either quadrant may be used for the first laying and points out the necessity for placing the paster in the same quadrant of the field of the telescope in all subsequent laying on the same aiming point. The gunner is then required to aim at this point several times, the instructor checking the aim each time. When the soldier has become proficient in aiming at pasters he is taught to aim at stakes, posts, poles, and larger objects. In aiming at such objects the cross lines are placed so that the vertical line coincides

with one edge of the object and the horizontal line coincides with the top, bottom, or some distinguishable mark on the object. The soldier is taught next to aim at natural targets such as small bushes, light and dark colored patches on the ground, and small features of the terrain that are readily distinguishable. In aiming at such targets the soldier must be impressed with the importance of selecting for his aiming point that part of the target on which he can most easily and quickly re-lay the cross lines after fire is opened. The gunner therefore should place the cross lines upon the most clearly defined part of the target whether it is the top, bottom, center, or side (fig. 11).

c. Aiming exercise.—(1) The equipment required for this exercise includes the following:

(a) 37-mm gun mounted on tripod with the telescopic sight in place.

(b) Target frame, 3 x 5 feet, covered with blank paper.

(c) Marking disk, 8-inch.

(2) The target frame listed above is the 1,000-inch machine-gun target issued by the Ordnance Department. The marking disk is 8 inches in diameter. It is made of tin or cardboard, painted black, and is mounted on a white wooden handle approximately 3 feet long. A hole is punched in the center of the disk just large enough to admit the point of a pencil.

(3) The exercise is conducted as follows: The gun is mounted on the tripod with the telescopic sight in place. A target frame covered with blank paper is placed 100 yards from the gun and the cross lines of the sight are laid on the blank target. The pupil takes the gunner's position and looks through the sights without disturbing the aim. An assistant designated as "marker" stands in rear of the target and places the marking disk on the blank target holding it firmly in position against the paper. By command or improvised signal, the pupil directs the marker to move the disk until it is in correct alinement with the cross lines of the sight (see circular object, fig. 11) and then commands: **MARK**. The marker without moving the disk makes a dot on the paper with a sharp pointed pencil inserted through the hole in the center of the disk. The marker then moves the disk to change the alinement. The pupil without disturbing the orig-

inal aim repeats this operation until three dots numbered 1, 2, and 3, respectively, have been made. These dots outline the shot group and the pupil's name is written under it. The size and shape of the shot group is discussed and the errors pointed out. This exercise is repeated until proficiency is obtained. The pupil should be able to make a shot group that can be covered by a $\frac{3}{4}$ -inch circle.

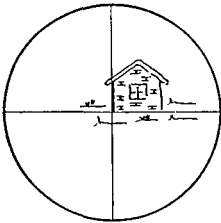

HOUSE

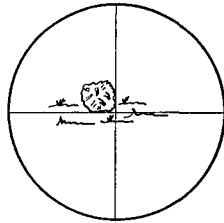

CIRCULAR OBJECT(BUSH)

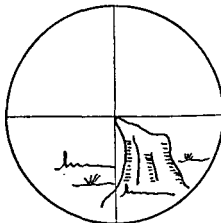

STUMP

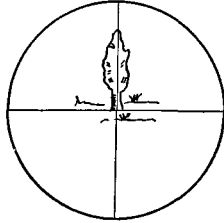

TREE

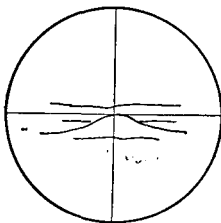

SMALL MOUND

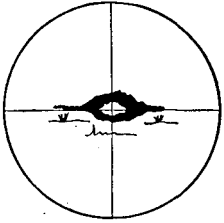

BARE SPOT ON GROUND

FIGURE 11.

d. Using an aiming point other than target.—When the gunner has been trained to use the target as an aiming point, he is next taught how to use an aiming point other than the target when the target does not offer a suitable aiming point. This method is described in paragraph 83. To impress the gunner with the necessity and importance of using a clearly defined aiming point instead of laying upon an indistinct target, he is required to lay upon an indistinct target, throw the line of aim off, and relay upon the target several times. This exercise will illustrate the difficulty of picking up an indistinct target. The instructor also emphasizes the fact that the smoke and dust caused by bursting shells make the target even more indistinct. After the reason for using an aiming point other than the target has been illustrated the gunner is taught that he can quickly lay the gun to hit the target by aiming at any well-defined point near the target. The first step is to lay the intersection of the cross lines upon the target with zero deflection and the range to the target set on the sight. Then by turning the deflection and range dials the intersection of the cross lines is moved to the selected aiming point and the gunner then calls out the new range setting on the sight. The gunner is given exceptionally thorough instruction in this method because it is frequently used in combat. Having been shown the necessity for using such an aiming point and instructed in the mechanical method of using one, the gunner is given practice in the selection of aiming points for various indistinct targets pointed out by the instructor.

■ 48. TRAINING IN INDIRECT LAYING.—*a. Sight-setting exercises.*—The gunner is trained how to set off range, deflection, and angle of site with the quadrant sight in a manner described in paragraph 22c. The gunner is instructed to set the quadrant sight by the methods of instruction described in paragraph 47a.

b. Laying for direction with quadrant sight.—(1) When the quadrant sight is used for indirect laying, the gun is laid for direction but not for elevation by alining the vertical line in the quadrant sight upon some aiming point in the same manner as the vertical cross line in the telescopic sight is alined (fig. 11).

(2) The gunner is instructed first in laying the vertical line of the collimator upon the simplest form of aiming point as, for instance, a vertical stake about 25 yards in front of the gun. The instructor first lays the gun and then requires the gunner to look through the sight. The gunner is then required to lay on the stake, repeating the operation several times until proficient. In laying upon such an aiming point one edge of the stake is used.

(3) The gunner is next taught to use other aiming points which present a vertical line upon which the vertical line of the collimator can be laid. Such aiming points are houses, poles, and trunks of trees. In using a house as an aiming point the edges of the chimney, sides of the windows, or the corners of the house are used in the same manner as the edge of a stake.

(4) The gunner is shown that deflection can be uniformly measured from any point on a vertical line, but that deflection measured from different points on an inclined line will vary. The gunner therefore is trained to pick out vertical lines as aiming points for direction and to lay the vertical line of the collimator upon them. The instructor checks the gunner's aim to see that he has selected a proper aiming point and that he has laid accurately upon it.

(5) It will often happen that aiming points which present vertical lines upon which to lay the vertical line of the sight cannot be found. For this reason the gunner is taught next to lay the vertical line upon a point. To do this the gunner lays on the aiming point by placing the vertical line of the collimator on the aiming point. Aiming points used in this instruction should at first be small pasters placed on a screen in front of the gun. When the gunner has become proficient in laying on a paster he is given practice in laying upon small natural objects.

(6) The next step in training the gunner to lay for direction by means of the quadrant sight is to practice him in selecting and laying upon aiming points on large objects such as buildings, trees, and bushes. He is called upon to select that point on such an object which makes the best point upon which to lay the vertical line of the collimator. The instructor checks the gunner's aim to see that he has

selected the most clearly defined point upon which to lay and that he has laid accurately upon it.

(7) The gunner is now taught how to provide a suitable aiming point for use in maintaining direction when the piece has been previously laid for direction. In teaching this method the instructor lays the piece for direction and tells the gunner that the piece is laid in the proper direction to hit the target but that the sight is not alined upon any aiming point. He then tells the gunner to aline the sight upon some aiming point which may be used to maintain the direction of the piece during firing. The gunner then selects a suitable aiming point, preferably a well-defined natural object on the ground to the front, and alines the vertical line of the collimator upon it by means of the range and deflection dials. He does not move the traversing handwheel during this operation as doing so will move the gun barrel from the proper direction to hit the target. Should the gunner not be able to find a suitable aiming point on the ground within the limits of movement of the deflection dials, he places a stake or other object in such position that it can be used as an aiming point. An ammunition box, a stone, or a piece of paper or cloth weighted down can be used. The gunner directs the placing of this aiming point a short distance in front of the gun in such position that the vertical line of the collimator can be brought upon it without changing the direction of the barrel. The gunner then alines the vertical line upon this aiming point as before by means of the range and deflection dials. In the firing of successive rounds the gunner relays for direction each time by alining the vertical line on the aiming point by means of the traversing handwheel.

c. Laying for elevation.—When the gunner has been taught to lay the piece for direction he is taught to lay the piece for elevation. The instructor announces the angle of site and range to be set off on the sight by the gunner. The instructor explains that the setting off of the angle of site and range does not move the axis of the bore, and that the next and last step in laying the gun for elevation is to center the bubble by means of the elevating handwheel. The instructor drills the gunner in laying the gun for elevation for

different angles of site and ranges until he is found to be proficient.

d. Determination of minimum range.—This operation is a mechanical one and the gunner will be made proficient in performing the operation before any attempt is made to explain to him the reasons for the various steps. The gun is set up behind a crest or behind any artificial object which may simulate a crest. The gunner is told that he can determine the least range at which he can fire over the crest from a given gun position with a given angle of site by the following steps:

(1) Set off the range to the crest on the range dial with the angle-of-site dial set at zero.

(2) Lay the gun by turning the elevating screw handwheel so that the horizontal cross line in the collimator just clears the top of the mask.

(3) Center the bubble by means of the range dial.

(4) Set off the angle of site of the target on the angle-of-site dial and read the minimum range on the range dial opposite the index on the angle-of-site dial, and announce the minimum range to the gun commander. The gunner is drilled in performing these four steps which comprise the operation of determining the minimum range until they become mechanical with him. This operation is quite different from laying the piece in indirect laying, yet the beginner will often confuse the two. For this reason the gunner will not be given instruction in determining the minimum range until he is thoroughly familiar with the methods of laying the piece. When the gunner has become proficient in the method of determining the minimum range, he is made to understand thoroughly its application in firing. He must realize that the minimum range is the least range which he can set off on the range dial and fire over a mask from a certain gun position as long as he uses the same angle of site on the angle-of-site dial as he used in determining the minimum range. He must also realize that when the gun commander announces a new angle of site or when the gun is moved to a new position he (the gunner) must find the new minimum range. He will also be taught to announce to the gun commander the minimum range immediately after it is

found. He will further be instructed that he is to notify the gun commander when a range less than the minimum range is announced in a fire order. When the gunner has a thorough understanding of the above method he may be taught how to find the minimum range by the shortest method for the same gun position for a new angle of site. This method consists of setting off the angle of site used in first determining the minimum range on the angle-of-site dial, setting off the minimum range first found on the range dial opposite the index on the angle-of-site dial, then without moving the range dial, setting off the new angle of site and reading the new minimum range on the range dial opposite the index on the angle-of-site dial.

■ 49. EXECUTION OF FIRE ORDERS.—After the gunner has been taught to lay the gun properly for direct laying, he is drilled in executing fire orders such as those described in paragraph 100 until he can lay the gun with speed and accuracy. Men are taught to execute fire orders for indirect laying in a like manner.

■ 50. DUTIES OF OBSERVER.—*a.* It is the duty of the observer to direct the gun squad in placing prompt and effective fire upon a target. He obtains the firing data for the first shot for the purpose of placing the first shot upon the target or as near to it as possible in a minimum time. During the firing he observes each burst and gives to the gunner the corrections in deflection and range necessary to bring the fire upon the target. The observer keeps himself informed of the position of friendly troops and when fire is to be delivered over their heads he is responsible that no firing is ordered which endangers them. When range cards are necessary he prepares them for the positions of his gun.

b. During firing the observer maintains a position from which he can see the target and be in communication with the crew at the gun. When direct laying is employed his position is at or near the gun, and his orders are given to the gunner by voice. In indirect laying when it is necessary for the observer to be at a short distance from the gun in order to see the target, he uses the simplest and most direct method of communicating with the gun crew. This method is by

voice direct to the gunner. The next best methods are by visual signals or by voice, with a man stationed between the observer and gun repeating the fire orders. If it is not possible to use either of these methods, communication is maintained by runner or by mechanical means such as the buzzer or telephone. The essential rule is that the more simple and direct the means of communication, the more prompt and effective will be the fire, and that if communication between observer and gun is interrupted the weapon becomes useless.

■ 51 TRAINING OF OBSERVER; DIRECT LAYING.—*a. General.*—When a soldier has been found proficient in the duties of gunner he is instructed in the duties of observer. The first step in training the observer is the method of obtaining the firing data for direct laying. It is here that training in the estimation of ranges is given. Instruction in target designation is also given for the purpose of enabling the observer to give to the gunner the firing data which have been found.

b. Training in preparation of range cards.—Range cards are prepared as described in paragraph 119. The men are divided into squads under noncommissioned officers and taken to suitable terrain. The officer in charge explains to the men the method of preparing range cards, requiring the men to perform each step of the work as he describes it. Noncommissioned officers supervise the work of their squads, pointing out any mistakes and requiring the men to correct such mistakes before proceeding with their work. The men are then required to prepare a range card of the same terrain without help from the instructor. The instructor collects these cards, points out any mistakes in them, and requires the men to correct these mistakes. This operation is repeated until the men are considered proficient.

c. Determination of ranges.—In combat the exact range required to hit a target will seldom be known prior to the opening of fire, and a material saving of time and ammunition will be effected by accurate range estimation. If fire is opened with an incorrect sight setting the position of the gun is often disclosed before fire falls on the target, thus increasing the probability of casualties in the gun crew, am-

munition is wasted, and overhead fire may be rendered unsafe.

(1) *Methods of determining ranges.*—The usual method of range determination used with the gun in combat is estimation by eye. Other means may be used but the main reliance must be placed on estimation by eye. Range finders are bulky, require trained observers, and must be kept in accurate adjustment. Measurement on the ground is practicable only in specially prepared defensive positions and in the absence of the enemy. Accurate maps are good but require more time than is usually available. Ranges may be secured from other troops, particularly when making a relief.

(2) *Necessity for training.*—(a) As estimation by eye must be depended upon in combat all men, and especially gun commanders, should be trained in this method. Stress should be laid on estimating ranges between 600 and 1,400 yards.

(b) The estimation by eye of untrained men is little better than a guess and the average errors of such men will be at least 12 percent of the range. A definite system of range estimation frequently practiced is the only way to make estimation by eye sufficiently reliable.

(3) *Method of estimation by eye.*—(a) Estimation by eye consists of measuring the range by applying to it a unit of measure 100 yards long. The method is the same as that employed in measuring the length of a board with a ruler. The only difference is that the soldier's unit of measure is applied mentally. Thorough familiarity with the 100-yard unit and its appearance on different kinds of ground and at different distances will enable the estimator to apply it with a fair degree of accuracy.

(b) Knowledge of terrain, life in the open, and training in scouting and patrolling are helpful in range estimation.

(c) Application of the unit of measure beyond 500 yards is difficult. For this reason in ranges over 500 yards it is better to select a point halfway to the target, apply the 100-yard unit up to this halfway point, and multiply the estimated distance by two.

(d) The average of a number of estimates by different men will generally be more accurate than a single estimate. However, in combat the gun commander must usually rely on his own estimation.

(4) *Conditions affecting appearance of objects.*—(a) Conditions of light and terrain have considerable effect upon the appearance of objects making them seem sometimes much nearer and at other times much more distant than they really are. The effect of these conditions on the appearance of the 100-yard unit of measure is negligible.

(b) In some cases much of the ground between the observer and the target will be hidden from view and the application of the unit of measure to the hidden portion of the ground will be impossible. In such cases the appearance of objects is the only guide.

(c) If there is a considerable stretch of visible ground extending from the far edge of the depression to the target it is best to estimate the distance to the far edge of the depression, judging by the appearance of objects, and then to apply the unit of measure over the remaining distance to the target.

(d) Whenever the appearance of objects is used as a basis for range estimation the observer must make allowance for the effects noted below:

1. Objects seem nearer when—

- (a) Object is in a bright light.
- (b) Color of the object contrasts sharply with the color of the background.
- (c) Looking over water, snow, or uniform surface like a wheat field.
- (d) Looking from a height downward.
- (e) In the clear atmosphere of high altitudes.
- (f) Looking over a depression, most of which is hidden.

2. Objects seem more distant when—

- (a) Looking over a depression, all of which is visible.
- (b) There is a poor light or fog.
- (c) Only a small part of the object can be seen.
- (d) Looking from low ground toward higher ground.

(5) *Exercises.*—(a) *No. 1.*

1. *Purpose.*—To familiarize the student with the unit of measure, 100 yards.

2. *Method.*—The unit of measure, 100 yards, is previously staked out over varied ground, using markers that will be visible up to 500 yards. The men are required to become thoroughly familiar with the appearance of the unit of measure from prone, kneeling, and standing positions at various ranges. They do this by moving away from and in prolongation of the lines staked out and studying the appearance of the unit from distances of 100, 200, 300, and 400 yards.

(b) No. 2.

1. *Purpose.*—To illustrate the application of the unit of measure.

2. *Method.*—Ranges up to 900 yards are measured accurately and marked at every 100 yards by large markers or target frames, each bearing a number to indicate its range. Men undergoing instruction are then placed about 25 yards to one side of the prolonged line of markers and directed to place a card, hat, or some other object before their eyes so as to cover from view all of the markers. They are then directed to apply the unit of measure five times along a straight line in the general direction but slightly to one side of the markers. When they have selected the final point reached by mentally applying the unit to the ground five times, the eye cover is removed and the estimations of the successive 100-yard points and the final point are checked against the markers. Accuracy is gained by repeating the exercise.

3. Ranges greater than 500 yards are then considered. With the markers concealed from view in the same manner as explained in 2 above, men estimate the ranges to points which are obviously over 500 yards distant and a little to one side of the line of markers. As soon as they have announced each range they remove their eye covers and check the range to the target and to

the halfway point by means of the markers. Prone, sitting or kneeling, and standing positions are used during this exercise.

(c) No. 3.

1. *Purpose.*—To give practice in range estimation.

2. *Method.*—From a suitable point ranges are previously measured to objects within 1,000 yards. The instructor conducts the class to the point where the men are required to estimate the ranges to the various objects that are pointed out by the instructor, writing their estimates upon paper previously issued. At least one-half of the estimates are made from prone or sitting positions. Thirty seconds are allowed for each estimate. When all ranges have been estimated, the papers are collected and the true ranges announced to the class. Individual estimates and squad averages are posted on bulletin boards accessible to all members of the class.

d. Field-glass and range-table method.—The observers are taught how to obtain the firing data necessary in indirect laying when an aiming point other than the target is used by means of the field-glass and range-table method. To do this the observers are trained in measuring angles with the horizontal and vertical mil scales in the type EE field glass. The instructor draws a rough diagram of the horizontal and vertical mil scales as they appear in the field glasses and gives a brief explanation of their use. He then stations the observers with field glasses about 25 yards from a blank white panel or the side of a building. He makes two marks of the same height on the panel and requires each observer to measure the horizontal angle between the two points. He checks their readings with his field glass or by use of the mil formula, since he knows the distance from the observers to the target and the distance between the two marks. The instructor then makes two marks on the panel, one above the other and requires the observers to read the vertical angle between the two points. This is checked in the same manner as the horizontal angle. Care must be taken that the men use the mil scale in reading the vertical angle rather than

the inverted sight leaf which is found in the field glasses. The observers are then instructed in the use of the angle-of-departure table in the determination of the range to be used when laying upon an aiming point above or below the target. This method is described in paragraph 83b. The instructor may give preliminary instruction in the use of this method by making two marks (one to represent the aiming point, the other to represent the target) on the panel which vary both in direction and elevation. He gives the observers an assumed range to the target as represented by one mark and requires each observer to compute the firing data necessary to use the aiming point represented by the other mark.

■ 52. INDIRECT LAYING; METHODS OF OBTAINING DIRECTION.—

a. General.—The various methods of obtaining the direction for indirect laying are described in paragraph 86. The observer is first taught the simplest and most commonly used methods. Later he may take up the more difficult methods. To comprehend the methods of obtaining direction by compass the observer is given training in the use of the lensatic compass, modified prismatic type, as prescribed in paragraph 19. The observer is given considerable practice in the use of compass, both in reading and setting off magnetic azimuths, before he can be considered proficient.

b. Determination of angle of site.—The first step in training an observer to determine the angle of site is to teach him to determine the horizontal. This is done indoors or on level ground which may be found adjoining the barracks. The instructor requires each observer receiving instruction to place a mark on the wall at the height of his eye. Each observer stands facing his mark on the wall at a distance of 10 yards or more if possible. He raises his extended arm, wrist straight, palm down, fingers extended and joined, until tips of the fingers are the same height as the mark on the wall. The tips of the fingers then indicate the level of the observer's eye. The observer repeats this step several times. He then practices locating the level of his eye without the mark which is covered by another man until the observer has located what he believes to be the level of his eye. After repeating this operation several times and checking each time by means of the mark, the observer is ready to proceed to the

next step. He is then taken to a position affording a good view of the terrain and is required to indicate different points on the ground to the front which he believes have the same elevation as his position. The elevations of these points are checked by the instructor using an angle-of-site instrument. When the observer has been given a few trials in the selection of these points and has shown a fair degree of accuracy in them, the method of obtaining the angle of site described in paragraph 88 is explained to the observer and he is practiced in using it. Only a few minutes' daily practice for several days is necessary to train an observer to estimate the angle of site with sufficient accuracy. If no angle-of-site instrument or other instrument designed for measuring angles of site is available, the point on the ground in front or in rear of the target having the same elevation as the gun position is found by means of the quadrant sight on the gun as follows: Set angle-of-site dial and range dial at zero and center bubble by means of elevating handwheel. The horizontal cross line is then laid upon all points in the field of sight having the same elevation as the gun position. This method can be used by the instructor in training observers to estimate the angle of site but cannot be used in action. The angle-of-site instrument is not issued to the gun commander for use in the field, the estimation of the angle of site by a trained observer being sufficiently accurate for the firing of the first round. Use of the angle-of-site instrument is confined to the training of the observer.

■ 53. FIRE CONTROL; FIRE ORDERS.—The observer is trained in giving fire orders (see par. 100) while other men are being trained in the duties of gunner. The fire order must be given in the prescribed sequence in order to avoid errors on the part of the gunner, and the different parts must be given at sufficient intervals to enable the gunner to set off the data on the sight as they are given. The observer will require the gunner to repeat the fire order correctly, step by step, as it is given.

■ 54. TRAINING IN ADJUSTMENT OF FIRE.—*a.* The best and most direct method of teaching the observer to conduct fire is by practice firing. However, ammunition allowances re-

strict the use of this method and it will be necessary for the instructor to devise other means. Training in adjustment of fire may be given in the classroom and a suitable method of teaching this subject is described in *b* below.

b. (1) Articles of equipment required are—

Blackboard.

Sand table.

Burst pointer.

Any desired terrain may be reproduced on the sand table as described in paragraph 153. The burst pointer is a classroom pointer split at one end with a small ball of cotton about $\frac{1}{2}$ inch in diameter placed securely in the split end to represent the "burst."

(2) The instructor first explains the method of sensing described in paragraph 103 and the method of correcting the errors thus sensed by means of fire commands. To illustrate this explanation he uses a blackboard to show a sketch of the line gun-target and a second line perpendicular to it through the target. He plots the bursts and explains their deviation from these lines as described in paragraph 103. The group to be instructed is then assembled at the sand table where exercises similar to those described in *c* below are conducted.

(3) The equipment is set up with the gun placed approximately 1,000 inches from the general area of the targets. The observation point may be at the gun position or to the flank, depending on the exercise. The observer uses the mil scale in the field glass, type EE, to measure deflection errors on the miniature terrain. Ranges are indicated by placing markers in depth along an edge of the sand table. Cards about 3 by 4 inches numbered to indicate ranges in hundreds of yards (10, 11, 12, etc.) are suitable markers.

c. Exercises.—(1) *No. 1 (direct laying).*—The instructor designates a target which is also the aiming point. The observer computes the initial firing data for engaging the target and gives the fire order. During the early stages of instruction the observer may pattern his fire order after a model on a blackboard near his position. When the observer has given his order, the instructor (standing alongside the sand table) says "On the way," and momentarily places the

tip of the burst pointer at a point on the range approximately where the fire order would cause the shot to strike. The observer estimates the errors in deflection and range and issues a fire order to correct them. This procedure is continued until the required final bracket is obtained.

Example.—The instructor designates a target that is also to serve as aiming point on the sand table at a range of 1,000; the observer gives the fire order "Low explosive, 1,100, zero, that stump, one round." The instructor places his pointer beyond the target; the observer sees that the burst is an "over" and issues the fire order "900, one round." The instructor places his pointer before and to the right of the target (to bring out a deflection change); the observer estimates the error in deflection with his field glasses, sees that the burst is a "short" and issues the fire order "1,000, left 10, one round." The instructor places his pointer in front or in rear of or hits the target, depending on the point he desires to bring out. Should the observer give an incorrect fire order such as right deflection instead of left deflection, the instructor places the burst as called for in order to emphasize the error by demonstration.

(2) *No. 2 (direct laying).*—The instructor places his pointer on an aiming point other than the target and points out the observation post. The observer computes the initial firing data for engaging the target. The actual vertical and horizontal differences in mils between the target and aiming point as measured with the field glasses on the sand table are used for calculating initial firing data. The observer issues the fire order and the instructor places the bursts until the problem is completed as in (1) above.

(3) *No. 3 (indirect laying).*—Before the exercise the instructor has two or three aiming stakes set up a few feet in front of the gun position, and a contour outlined on the miniature range and arbitrarily assumed to be on level with the gun so as to give a zero angle of site. The instructor designates a target and points out the observation post. The observer computes the initial firing data by measuring the horizontal difference in mils between the target and the aiming stake, the vertical difference in mils between the "zero angle-of-site contour" and the target for the plus or minus

angle of site, and by estimating the range. The observer issues the fire order and the instructor places the bursts until the problem is completed as in (1) above.

(4) *Other exercises.*—When the observer has progressed sufficiently he works out more difficult problems to bring out the necessity of remembering where bursts at certain ranges appeared; the necessity of constant study of the terrain so as to recognize when bursts are “lost over” a hill, “lost short” in a ravine in front of a target, “lost in a woods on a flank,” and the like; the necessity of studying wind conditions as when a cross wind causes the smoke to go across in front of or behind a target; correcting a shot in deflection only as when the burst appears to be correct as to range but off the line from gun to target, and determining whether the shot is an “over,” a “short,” or a “target” at that range when on the line gun-target; and the necessity of making corrections for the difference between the observed error in deflection and the actual deflection to be set off on the sights, depending on the position of the observer in front, rear, or flank of the gun.

SECTION II

EXAMINATION

■ 55. PLACE AND DATE OF EXAMINATION.—Examinations will be held once each year to determine the proficiency and qualification of personnel under instruction. These examinations will be held where the company is serving and at a time least interfering with field training, the date being designated in conformity with these regulations by the commanders who convene the boards.

■ 56. SUBJECTS OF EXAMINATION.—*a. Gunner's test.*

<i>Subjects</i>	<i>Value</i>
(1) Direct laying.....	100
(2) Indirect laying.....	100
<i>b. Expert test.</i>	
(1) Range cards.....	100
(2) Computation of firing data.....	100
(3) Individual field firing.....	100

■ 57. EXAMINING BOARDS; APPOINTMENT AND CONSTITUTION.—The examination will be conducted by a board of three or more officers, not more than one of whom is a member of the same company as the man being tested. Whenever possible, one member of the board will be an officer serving with the 37-mm gun unit. Boards will be appointed by the commanders having authority to issue qualification orders as provided in AR 35-2380.

■ 58. GENERAL RULES GOVERNING EXAMINING BOARDS.—The following rules will govern examining boards:

a. The conditions of the examination will be made as nearly as possible equally difficult for all candidates. The board will be held responsible that *no data obtained by a candidate during a particular test are transmitted to any other candidate who is to take that test under identical conditions*; also, that no candidate receives the benefit of any sight setting or laying of the weapons as left by a previously tested candidate.

b. Setting of scales on the gun will be considered correct if any part of the index is coincident with any part of the line of graduation of the setting ordered.

c. Settings ordered by the board will always be even divisions of the scale and not fractions thereof.

d. The candidate will be permitted to traverse the gun to the middle point of traverse before each trial at direct or indirect laying.

e. The telescopic or quadrant sight will be in position on the gun before the command for any trial with it is given, the scales being set at zero at the beginning of each test.

f. Changes in setting of scales required of candidates will not exceed the following: Deflection scale, 20 mils; range scale, 600 yards. At no time during a trial will any setting or change be ordered which requires a sight setting beyond the limits of the scale. During trials requiring the use of the spirit level the level bubble will be thrown out of center after each trial.

g. Should any candidate fail in any trial through the fault of an examiner or an assistant, or of the sight or other instrument used, that trial will be void and the candidate immediately will be given another trial of the same nature.

- h.* The candidate may select the assistants authorized.
i. Each candidate will be given the tests in the order in which they are described in sections III and IV below.

■ 59. CERTIFICATE OF COMPANY COMMANDER AS TO QUALIFICATION OF CANDIDATES.—Each 37-mm gun unit commander will submit to the board a list of the members of his command who are to appear for examination. He will certify on the list submitted by him that the candidates who have not previously qualified as second-class gunners or better are, as determined by a preliminary examination conducted under his supervision, well instructed in the care and use of matériel, drill of the gun squad, safety precautions to be observed during firing, and in the subjects of the examination.

■ 60. RECORDS AND REPORTS.—See AR 345-1000.

SECTION III

QUALIFICATION COURSE, GUNNER'S TEST

■ 61. GENERAL.—See AR 775-10 for information as to who will fire the several courses, individual classification, qualification, ammunition allowances, etc.

■ 62. SCOPE OF SUBJECT NO. 1.—Tests in Subject No. 1 include direct laying of the gun as follows:

- a.* Sighting triangles.
- b.* Laying on target.
- c.* Change in fire data.
- d.* Laying on aiming points.

■ 63. DIRECT LAYING SIGHTING TRIANGLES.—*a.* Triangles will be made, using the telescopic sight, as prescribed in paragraph 47c, under the following conditions:

	Test A	Test B
Distance.....	100 yards.....	50 yards.
Number of triangles.....	4.....	2.
Diameter of disk.....	8 inches.....	4 inches.

b. All triangles made by a candidate will be on the same sheet of paper which will be marked with his name.

c. Each triangle will be graded as follows:

	Test A	Test B	Score
No one side longer than.....	$\frac{3}{4}$ inch.....	$\frac{1}{2}$ inch.....	5
No one side longer than.....	1 inch.....	$\frac{3}{4}$ inch.....	3
No one side longer than.....	$1\frac{1}{4}$ inches.....	1 inch.....	1
Total score possible.....	20 points.....	10 points.....	

■ 64. DIRECT LAYING ON TARGET.—a. Three X targets will be set up 25 yards from the gun. The distance between the targets for test "A" will be 15 yards, and for test "B," 5 yards.

b. Each candidate will have trials in laying on an aiming point as follows:

	Test A	Test B
With the telescopic sight.....	4	2
With the quadrant sight.....	4	2

c. With the candidate in a prone position behind the trails, the range and deflection dials on the sight set at zero and the gun in position on wheels, an officer will give a command for laying on one of the targets, for example:

1,200.

LEFT 10.

RIGHT TARGET.

d. The candidate will repeat the order. At the announcement of the range he will grasp the trails and point the barrel in the direction of the designated target, take the position of gunner on the left trail, set off deflection and range in compliance with the order, lay on the target, and call "Ready." Before the gun is laid an assistant will seat the spades into the ground by jumping on the trails. The candidate will be careful not to move his position any more than necessary when the laying is checked.

e. The same quadrant of the field of the telescopic sight will be used in each trial, and the cross lines of the quadrant placed tangent to the bull's-eye. When the quadrant sight is used the intersection of the cross lines will cover the bull's-eye.

f. Time will be taken from the announcement of the range by the officer to the announcement of "Ready" by the candidate.

g. In each trial a different target, deflection, and range will be ordered. No credit will be given in the following cases:

(1) If the sight is incorrectly set for deflection or range.

(2) If either cross line is more than 1 mil off its proper laying.

h. If the piece is found to be correctly laid within the limits prescribed credits will be given as follows:

	Test A	Test B
Time in seconds exactly or less than.....	11-12-14-16-18	13-15-17-19-21
Credits.....	5 4 3 2 1	5 4 3 2 1
Total score possible.....	40 points	20 points

■ 65. DIRECT LAYING CHANGE IN FIRE DATA.—a. Each candidate will have trials in applying changes in fire data to the sight and re-laying on the aiming point as follows:

	Test A	Test B
With the telescopic sight.....	4	2

b. The candidate will take the position of gunner on the left trail with his hands on the elevating and traversing hand-wheels. With a given deflection and range set on the sight and with the gun laid on an aiming point, an officer will announce a deflection change and a range change not exceeding the limits prescribed in paragraph 58f. For example, the range being set at 1,000 and the deflection at left 10 and the gun laid on an aiming point, an officer will command:

800.

RIGHT 20.

c. The candidate will repeat the order, set off the data ordered, re-lay on the aiming point, and call "Ready."

d. Time will be taken from the announcement of the range by the officer to the announcement of "Ready" by the candidate.

e. No credits will be given in the following cases:

(1) If the range or deflection dial is incorrectly set for the change announced.

(2) If either cross line is more than 1 mil off its proper laying on the aiming point.

f. If the piece is found to be correctly laid within the limits prescribed credits will be given as follows:

	Test A	Test B
Time in seconds exactly or less than.....	7-8-9-11-13	7-8-9-11-13
Credits.....	5 4 3 2 1	5 4 3 2 1
Total score possible.....	20 points	10 points

■ 66. DIRECT LAYING ON AIMING POINTS.—a. Three or more aiming points will be set out in such a manner that the angular distance in azimuth or elevation between any two is not less than 5 mils or greater than 20 mils. The aiming points will be capable of clear definition through the sights. White stakes about 4 inches wide and cut squarely at the top are preferable for test "A." Black pasters on a white background are more suitable for test "B."

b. Each candidate will have trials as follows:

	Test A	Test B
With the telescopic sight.....	4.....	2.
Distance, aiming points from gun.....	100 yards.....	50 yards.
Kind of aiming points.....	Stakes.....	Pasters.

c. The gun will be placed firmly in position so that it will not be necessary to move the trail to lay upon either aiming point. With both range and deflection dials set at zero, the candidate in the gunner's position on the left trail with his

hands on the elevating and traversing handwheels, an officer will command, for example:

1,000.

ZERO.

LEFT TOP OF CENTER STAKE (OR CENTER PASTER).

SELECT AN AIMING POINT.

d. The candidate will set off the range as soon as it is announced and lay on the target designated in the command. He then will move the cross lines to the selected aiming point by means of the range and deflection dials and announce the new range setting. In succeeding trials the data in the commands will be varied. Time will be taken from the announcement of the range by the officer to the announcement of the new range setting by the candidate.

e. No credits will be given in the following cases:

(1) If the range and deflection found differ by more than 2 mils in deflection and 25 yards in range from the range and deflection determined by the board.

(2) If either cross line is more than 1 mil off its proper laying on the aiming point.

f. If the piece is found to be laid correctly within the prescribed limits credits will be given as follows:

	Test A	Test B
Time in seconds exactly or less than.....	13-14-16-18-20	13-14-16-18-20
Credits.....	5 4 3 2 1	5 4 3 2 1
Total score possible.....	20 points	10 points

■ 67. MAXIMUM CREDITS FOR DIRECT LAYING.—Total possible credits for—

	Test A	Test B
<i>a.</i> Sighting triangles.....	20	10
<i>b.</i> Laying on target.....	40	20
<i>c.</i> Change in fire data.....	20	10
<i>d.</i> Laying on aiming points.....	20	10
<i>e.</i> Direct laying.....	100	50

■ 68. SCOPE OF SUBJECT No. 2.—Tests in Subject No. 2 include indirect laying of the gun as follows:

- a. With first fire data.
- b. With change in fire data.
- c. To measure minimum range.
- d. By compass.

■ 69. INDIRECT LAYING WITH FIRST FIRE DATA.—a. A well-defined vertical aiming point (such as a telegraph pole or a heavy line) will be used.

b. The candidate will have trials as follows:

	Test A	Test B
With the quadrant sight.....	4.....	2.
Distance A P from gun not less than.....	100 yards.....	50 yards.

c. With the candidate in the gunner's position on the left trail and with the piece so placed that it will not be necessary to move the trail to lay on the aiming point, an officer of the company will command, for example:

MINUS 10.

1,500.

LEFT 15.

TO YOUR FRONT, THAT TELEGRAPH POLE.

d. The candidate will set off the data as received; that is, angle of site, range, and deflection, and lay the vertical line of the collimator on the aiming point, and by turning the elevating screw handwheel center the bubble.

e. As soon as the gun is laid the candidate will call "Ready."

f. Time will be taken from the announcement of the angle of site by the officer to the announcement of "Ready" by the candidate.

g. No credits will be given in the following cases:

(1) If the sight is incorrectly set for deflection, site, or range.

(2) If the level bubble is not more than half inside the two lines on the glass tube.

(3) If the vertical line is more than 1 mil off the aiming point.

h. If the piece is found to be correctly laid within the limits prescribed, credits will be given as follows:

	Test A	Test B
Time in seconds exactly or less than.....	13-14-16-18-19	15-16-18-20-22
Credits.....	5 4 3 2 1	5 4 3 2 1
Total score possible.....	20 points	10 points

■ 70. INDIRECT LAYING CHANGE IN FIRE DATA.—*a.* The candidate will have trials as follows:

	Test A	Test B
With the quadrant sight.....	4	2

b. With a given deflection, angle of site, and range set on the sight, the vertical line of the collimator laid on an aiming point and the bubble centered, an officer of the company will announce a range and deflection change not to exceed the limits prescribed in paragraph 58*f.* For example, with the range set at 1,000, deflection at left 10, an officer of the company will command:

800.

RIGHT 20.

c. The candidate will set off the data ordered, re-lay the vertical line on the aiming point, center bubble, and call "Ready."

d. Time will be taken from the announcement of the range by the officer to the candidate's announcement "Ready."

e. No credits will be given in the following cases:

(1) If the sight is incorrectly set for deflection, angle of site, or range.

(2) If the level bubble is not more than half inside the two lines on the glass tube.

(3) If the vertical line is more than 1 mil off the aiming point.

f. If the piece is found to be correctly laid within the limits prescribed credits will be given as follows:

	Test A	Test B
Time in seconds exactly or less than.....	10-11-13-15-16	11-13-15-17-19
Credits.....	5 4 3 2 1	5 4 3 2 1
Total score possible.....	20 points	10 points

■ 71. INDIRECT LAYING TO MEASURE MINIMUM RANGE.—*a.* The candidate will have trials in measuring the minimum range over a mask as follows:

	Test A	Test B
With the quadrant sight.....	3	2

b. Different ranges to mask and angles of site will be assumed for each trial.

c. With the gun in position pointed toward mask and with range and deflection dials set at zero, an officer of the company will command, for example:

RANGE TO MASK, 400.

ANGLE OF SITE, MINUS 10.

d. The candidate will set off the data as received and announce the minimum range.

e. Time will be taken from the announcement of the range to the mask by the officer to the announcement of the minimum range by the candidate.

f. No credits will be given in the following cases:

(1) If the angle of site is incorrectly set.

(2) If the minimum range announced differs by more than 50 yards from the minimum range determined by the board.

g. If the minimum range is found to be correct within the limits prescribed credits will be given as follows:

	Test A	Test B
Time in seconds exactly or less than.....	12-14-16-17-18	14-15-17-19-20
Credits.....	10 8 6 4 2	10 8 6 4 2
Total score possible.....	30 points	20 points

■ 72. INDIRECT LAYING BY COMPASS.—*a.* The candidate will have trials, using the compass, in laying the piece on a given magnetic azimuth as follows:

	Test A	Test B
Number of trials.....	3	1

b. The selected firing position will be marked by a low, flat-topped stake or some small object.

c. The gun with quadrant sight attached will be set up as in ON WHEELS, ACTION (ch. 2) 15 yards from the selected firing position but not necessarily pointed in the direction of fire, and an officer of the company will command, for example:

MAGNETIC AZIMUTH, 2,200.

d. The candidate will estimate the approximate direction of the azimuth ordered and direct an assistant to move out about 25 yards in that direction. The candidate then, by employing the compass, will direct the assistant to drive a stake in such a position that it will have the required azimuth from the gun, place the gun in such a position that the sight is approximately over the stake or other object indicating the gun position, lay the vertical line of the collimator on the aiming stake and call "Ready."

e. Time will be taken from the announcement of the magnetic azimuth by the officer to the candidate's "Ready." The board will check the direction of the aiming stake from the gun by reading the azimuth from the aiming stake to the stake at the firing position and converting it to back azimuth. No credit will be given if the piece is laid more than 40 mils off the magnetic azimuth commanded. Credits will be given as follows:

	Test A	Test B
Time in seconds exactly or less than.	90-105-120-135-150-180	90-105-120-135-150-180
Credits:		
Error of 0-20 mils.....	10 9 8 7 6 5	10 9 8 7 6 5
Error of 21-40 mils.....	8 7 6 5 4 3	8 7 6 5 4 3
Total score possible.....	30 points	10 points

■ 73. MAXIMUM CREDITS FOR INDIRECT LAYING.—Total possible credits for—

	Test A	Test B
a. First fire data.....	20	10
b. Change in fire data.....	20	10
c. Measuring minimum range.....	30	20
d. Laying by compass.....	30	10
e. Indirect laying.....	100	50

SECTION IV

QUALIFICATION COURSE, EXPERT'S TEST

■ 74. SCOPE.—This test is divided into three subjects as follows:

- a. *Subject No. 1.*—Preparation of range cards.
- b. *Subject No. 2.*—Computation of firing data.
- c. *Subject No. 3.*—Individual field firing.

■ 75. RANGE CARDS.—a. This test includes the preparation of a range card as prescribed in paragraph 119 for a defensive position.

b. The position and sector will be selected by the examining board. The sector will include a reference point and four target positions, each of which will be definitely located by some distinctive feature of the terrain and pointed out on the ground to the candidate. The target positions will be between 500 and 1,500 yards from the selected gun position and at least 100 mils in azimuth from the reference point.

c. The same position and sector will be used for all candidates examined on any one day, and if practicable all candidates serving at the same post will be examined on this subject on the same day.

d. The candidate will be furnished a lensatic compass, modified prismatic type.

e. Ranges will be estimated.

f. All range cards will be made out on blank paper furnished by the examining board.

g. No credit will be allowed for any range card not submitted within 30 minutes.

h. Correct ranges, angles of site, and azimuth angles will be determined by the examining board, and each target as shown on the candidate's range card will be graded for accuracy as follows:

(1) Percentage of error in range					
exactly or less than-----	15	20	25	30	35
Credits-----	10	8	6	4	2
Total possible for range estimation (4 targets and reference point) -----	50				
(2) Error in azimuth angle exactly or less than (mils)-----	10	15	20	25	
Credits-----	4	3	2	1	
Total possible for azimuth measurements (4 targets and reference point)-----	20				
(3) Error in angle of site exactly or less than (mils)-----	10	20			
Credits-----	2.5	1			
Total possible for angle of site estimation (4 targets)-----	10				
(4) For the recording, proper placing, and legibility of each of the following on the range card:					
					<i>Credits</i>
Base line and range arcs-----					0.5
Calibration of range arcs-----					.5
Diagrammatic sketch of each target and RP-----					2.5
Nominal designation of each target and RP-----					2.5
Numerical designation of each target-----					2.0
Accentuation of zero line-----					.5
Range to RP and to each target-----					2.5
Magnetic azimuth of RP and of each target-----					2.5
Angle of site of each target-----					2.0
Arrow and letter indicating magnetic north-----					1.0
Type and number of emplacement-----					1.0
Name, grade, and organization of candidate-----					1.5
Place and date-----					1.0

Total possible (for completeness, correct technique, and legibility)-----					20.0

i. Total possible for preparation of range cards (Subject No. 1), 100.

■ 76. COMPUTATION OF FIRING DATA.—*a.* A well-defined target visible from both the observation post and the gun position will be set out or selected by the examining board. The target will be between 500 and 1,500 yards from the gun position. The observation post will be between 100 and 200 yards from the gun position and at least 100 yards to one flank of the line gun-target. The target and gun position will be designated to the candidate from the observation post, and he will not be allowed to move from this position while computing the required data.

b. The candidate will be furnished a compass and field glass, type EE. No other instrument will be used.

c. The candidate will determine the magnetic azimuth, angle of site, and range from gun to target.

d. The correct data will be determined by the examining board, using the same compass as the candidate.

e. No credits will be allowed for any data not submitted within 5 minutes.

f. Firing data submitted within the prescribed limit will be graded as follows:

(1) Magnetic azimuth gun-target—

Error in mils, exactly or				
less than	30	40	50	
Credits.....	35	30	25	

(2) Angle of site gun-target—

Error in mils, exactly or						
less than	—	—	—	10	15	20
Credits.....	—	—	—	30	25	20

(3) Range gun-target—

Percentage of error, ex-						
actly or less than.....	10	15	20	25	30	35
Credits.....	35	30	25	20	15	10

g. Total possible for computation of firing data (Subject No. 2), 100.

■ 77. INDIVIDUAL FIELD FIRING.—*a. Regulations.*—Each candidate will conduct the firing of one problem in—

(1) Direct laying using aiming point other than the target.

(2) Indirect laying.

b. Grading.—The conduct of each problem will be graded upon the following basis:

(1) Accuracy of original fire order.....	15
(2) Accuracy of observation of errors.....	15
(3) Conduct of fire, issuing and transmitting fire orders, method of adjusting fire, decision, and promptness	20
Total for one problem.....	50

c. Total credits possible for one problem in firing with direct laying and one problem in firing with indirect laying, 100.

d. Procedure.—Individual field firing with the 37-mm gun will be conducted under the following conditions:

(1) Only those who have made 85 percent of the total possible 200 points in Subjects Nos. 1 and 2 of the expert test will fire (par. 56b).

(2) For each problem—

(a) The target will be designated clearly to the candidate.

(b) The candidate will compute the firing data and give the gunner the necessary order to enable him to lay the piece and open fire upon the target.

(c) After firing has commenced, the candidate will observe all bursts and make the proper corrections until fire is adjusted upon the target.

(d) The actual range to target will not be less than 500 yards nor greater than 1,500 yards.

(e) The authorized ammunition allowances will not be exceeded.

(3) The board will terminate a problem when it is considered that the conduct of fire is inefficient or that fire has been adjusted on the target. No fire for effect will be ordered.

(4) In the direct laying problem the telescopic sight will be used. A clearly defined aiming point will be employed. The candidate will be required to measure by means of his field glass the angle in azimuth and the angle in elevation between the target and the aiming point and compute the necessary firing data from these measurements.

(5) In the indirect laying problem the gun will be in such a position that no part of the gun or crew will be visible from

the target, but the candidate by standing upright at or near the gun position can see the target. The quadrant sight will be used.

(6) If practicable, all members of the unit except those who are yet to take the firing test will be permitted to witness the firing.

(7) No person will correct or coach the candidate at any time during firing, and no one except an official conducting the examination will communicate or in any way interfere with any person connected with the firing.

■ 78. MAXIMUM CREDITS FOR EXPERT TEST.—

Subject No. 1, range cards.....	100
Subject No. 2, computation of firing data.....	100
Subject No. 3, individual field firing:	
Direct laying.....	50
Indirect laying	50
	100
Total possible for expert test.....	300

SECTION V

TARGETS, RANGES, AND SAFETY PRECAUTIONS

■ 79. TARGETS.—Targets for firing are natural features of terrain. Artificial targets such as panels and silhouettes should only be used when the terrain available for firing is not varied enough to furnish reference points or targets.

■ 80. RANGES AND SAFETY PRECAUTIONS.—*a.* Range areas and safety precautions for firing must conform with the instructions set forth in AR 750-10.

b. Misfires.—Care must be used in handling misfires to avoid accident. When a misfire occurs the gun will be cocked by hand, and without opening the breech the trigger crank lever will again be pressed. At least three attempts to fire the primer will be made. If the round still fails to fire, wait one minute for a possible "hangfire," then remove the round from the chamber and examine its primer. If the primer is properly dented, the round is defective and should be discarded. If the primer is not dented, the firing pin is probably broken.

It should be examined and replaced if necessary. If the primer is but slightly dented, the striker is improperly adjusted or the striker spring weak. To adjust the striker, push it to complete forward position, examine it, and screw or unscrew the nut on the striker rod a few turns, the direction of screwing depending upon the position of the nut. The gun usually operates properly when the striker rod nut is screwed to a position where the end of the rod is flush with the nut. If this action does not remedy the condition, replace the striker spring.

CHAPTER 4

TECHNIQUE OF FIRE

	Paragraphs
SECTION I. Direct laying.....	81-83
II. Indirect laying.....	84-92
III. Overhead fire.....	93-98
IV. Fire control and adjustment.....	99-105
V. Firing against moving targets.....	106-112
VI. Other firing methods.....	113-117
VII. Range cards.....	118-119

SECTION I

DIRECT LAYING

■ 81. GENERAL.—*a.* Direct laying is the technique required to engage a target that can be seen by the gunner from his position on the trail.

b. When the target is distinctly visible and offers a well-defined aiming point, the gunner may lay directly on that part which he desires to hit. This method offers the advantage of reducing to a minimum the time preliminary to the first round. It has the disadvantage that in fire for effect the target may be obscured by bursting shells, thus causing the gunner to lose sight of his aiming point.

c. When the target cannot be designated easily to the gunner, or offers a poor aiming point, or is likely to be obscured by smoke or dirt from bursting shells, an aiming point other than the target is ordinarily used.

d. The telescopic sight (par. 21) is designed for direct laying. The required direction and elevation are applied to the gun by setting the deflection and range dials at the deflection and range announced in the fire order, then manipulating the traversing and elevating mechanism until the cross lines are laid on the aiming point. The aiming point should appear within one of the quadrants formed by the intersecting cross lines touching the line segments, as shown

in figure 11. In laying for succeeding rounds fired on the same target the same quadrant should be used. The part of the object most clearly defined should be used as the aiming point. The eye should be placed firmly against the eyeshield so that no light enters. When the field of vision is a true circle the eye is in the proper position.

■ 82. USING TARGET AS AIMING POINT.—To lay the gun when the target is the aiming point—

a. Set range dial at the range to the target as given in the fire order.

b. Set deflection dial at the announced deflection, usually zero.

c. By means of the elevating and traversing handwheels of the gun lay the intersection of the cross lines upon that part of the target selected for an aiming point.

■ 83. USING AN AIMING POINT OTHER THAN TARGET.—*a. Mechanical method.*—This method is used when the target does not offer a good aiming point or when it is likely to be obscured by smoke or dirt resulting from the bursting of shells, especially during fire for effect. The mechanical part of the work is performed by the gunner either upon instructions from the gun commander or upon his own initiative if he finds the target is a poor aiming point. The gunner must announce to the gun commander the final setting on the range dial of the sight as this setting is the result of his action and must be known by the gun commander when adjusting fire. To compute firing data by the mechanical method proceed as follows:

(1) Set deflection and range dials in compliance with the data given in the fire order.

(2) Lay the gun, using the target as an aiming point, by manipulating the traversing and elevating mechanism.

(3) Without disturbing the laying of the gun, turn deflection and range dials of the sight until the cross lines are laid on the selected aiming point.

(4) Announce the new reading on the range dial to the gun commander. The gun is re-laid for each round after the first by applying corrections as given in adjustment orders on the sight and re-laying on the same aiming point.

It is necessary for the gun commander to know the new range setting introduced by moving the cross lines of the sight to the new aiming point in order that he may give correct fire orders.

Range table for 37-mm gun, HE shell Mk. II, muzzle velocity 1,276 f/s

(Extract of 37-A1)

Range	Elevation	Range	Elevation	Range	Elevation
<i>Yards</i>	<i>Mils</i>	<i>Yards</i>	<i>Mils</i>	<i>Yards</i>	<i>Mils</i>
0	-5	700	23	1,400	60
100	-2	800	28	1,500	66
200	+2	900	33	1,600	73
300	6	1,000	38	1,700	79
400	10	1,100	43	1,800	86
500	14	1,200	49	1,900	93
600	19	1,300	54	2,000	100

b. Mil-scale and range-table method.—In many cases the target is obscure and difficult to designate. The observer can see the target with his field glasses which have a greater magnifying power than the sight used by the gunner. Therefore he can select an aiming point other than the target and by calculation determine the firing data which will enable the gunner to lay on the selected aiming point and give the gun the necessary direction and elevation to engage the target. To compute the firing data by means of the mil-scale and range-table method, proceed in the manner described below. From a position at or near the gun—

- (1) Estimate the range to the target.
- (2) By means of the mil scale in the field glasses, measure the horizontal angle in mils from the aiming point to the target.
- (3) By means of the mil scale in the field glasses, measure the vertical angle in mils between the aiming point and target.
- (4) Refer to the range table (37-A1) and determine the angle of elevation which corresponds to the estimated range to the target. Increase or decrease this angle of elevation,

depending on whether the aiming point is below or above the target, by the measured vertical angle, aiming point to target.

(5) Find in the range table the range equivalent to the new angle of elevation obtained by the above computation. This is the range to be used for the first round.

(6) The deflection to be set off on the sight is the horizontal angle in mils as read from aiming point to target.

Discussion.—Setting off right (left) deflection on the deflection dial of the sight will cause the projectile under normal conditions to strike to the right (left) of the aiming point on which the gun is laid. Therefore if the horizontal angle read from aiming point to target is right 20 mils, and a deflection setting of right 20 is set on the sight, and the cross lines of the sight laid on the aiming point by manipulating the traversing mechanism, the barrel will be given proper direction for opening fire on the target. If the range to a target is set off on the range dial and the gun laid on the target by manipulating the elevating mechanism until the intersection of the cross lines of the sight is on the target, the barrel is given the proper elevation above the line of aim to cause the projectile to strike the target. If the aiming point to be used is *above* the target a certain number of mils, this vertical angle in mils must be *deducted* from the angle of elevation required on the gun for the projectile to strike the target if the target itself were used as an aiming point. If the aiming point to be used is *below* the target, the vertical angle in mils, aiming point to target, must be *added* to the angle of elevation required on the gun in order for the projectile to strike the target if the target itself were used as an aiming point.

Example.—The gun commander wishes to calculate firing data for opening fire on a target estimated to be 1,200 yards from the gun. By using his field glasses he measures the horizontal angle aiming point to target to be right 15 mils, and the vertical angle from aiming point to target to be 20 mils. The aiming point is above the target. Referring to the fire-control tables he sees that the angle of elevation for 1,200 yards is 49 mils. 49 minus 20 equals 29 (aiming point above target). Again referring to the fire-control tables

he sees that an angle of elevation of 29 mils is equivalent to a range of 820 yards. The data used in his fire order then should be deflection right 15, range 800, using the nearest range in hundreds.

c. The 5-mil method.—The 5-mil method of calculating data for using an aiming point other than the target is based on the mil-scale and range-table method. It is rapid and sufficiently accurate for practical field work. It will be seen from the fire-control tables that for average combat ranges of the gun the angles of elevation differ by approximately 5 mils for ranges differing by 100 yards. Recognizing this fact the observer can obtain the range to be used for an aiming point above or below the target without reference to a table by making a correction of 100 yards in range setting for each 5 mils which the aiming point is above or below the target.

Example.—The gun commander wishes to calculate firing data to open fire on a target 1,000 yards from the gun. He wishes to use an aiming point which is to the right of and *below* the target. By using his field glasses he reads the horizontal angle aiming point to target to be left 25 mils, and the vertical angle aiming point to target to be 15 mils. Based on the fact that a change of 5 mils in elevation is equivalent to a change of 100 yards in elevation, he corrects the range to the target by 300 yards ($\frac{1}{5} \times 100 = 300$). The data given in his fire order will then be deflection left 25 mils and range 1,300 yards. The correction is added since the aiming point is below the target.

SECTION II

INDIRECT LAYING

■ 84. GENERAL.—*a.* Indirect laying is the technique required in order to engage a target that cannot be seen by the gunner from his position on the trail. The three problems involved in this type of fire are direction, elevation, and minimum range. In order to engage a given target it is necessary first to establish the direction of the line gun-target, then to determine the angle through which it is necessary to elevate the barrel from the horizontal in order for the projectile to strike the target, and finally to determine the minimum range, that is, the least range setting which will insure the pro-

jectile clearing the mask to the front while engaging the target from one position.

b. The quadrant sight (par. 22) is designed for indirect laying. The required direction (with exception of the position defilade method) and elevation are applied to the gun by setting the deflection dial, angle-of-site dial, and range dial in accordance with the data given in the fire order, then laying the vertical line of the collimator on the aiming point by means of the traversing mechanism and finally centering the bubble in the level vial by means of the elevating mechanism.

■ **85. PROCEDURE.**—When the observer sees the target he immediately determines the range and angle of site, and except in the case of position defilade selects or establishes a suitable aiming point. The general sequence of procedure for application of indirect laying after the target has been located and recognized is as follows:

a. Establishment of direction of target (assisted by No. 3, if necessary).

b. Mounting gun for action on wheels or tripod.

c. Announcement by observer to gunner of angle of site of target.

d. Determination of minimum range by the gunner and his announcement of same to observer.

e. Announcement by observer to gunner of fire order and gunner's repetition of same.

f. Fire adjustment and fire for effect to execute the given mission.

g. Changing position or going out of action.

■ **86. ESTABLISHING DIRECTION.**—Several alternative methods for establishing direction are described below. Each method is practical and sufficiently accurate for opening fire on a given target. Different conditions demand the use of different methods. The one to be used in any particular situation is left to the discretion of the observer who is usually the gun commander. The methods described for use from position defilade and for use of a natural aiming point are almost as rapid as direct laying and permit added protection for the gun crew due to an intervening mask.

a. From position defilade.—The gun is said to be in position defilade when it is so located just behind a crest that the gun and men lying on the trails are obscured from the enemy's view, but the observer standing at the gun is able to see the target. A gun in such a position is laid by the following procedure: The observer grasps the trails and moves them until the barrel is pointed in the direction of the target. The gunner takes position and turns the deflection dial until the vertical line of the collimator is alined on some clearly defined object which can be used as an aiming point. This aiming point may be a stone or other object in the immediate foreground or an object on the sky line. If no suitable object is visible something may be thrown on the ground in front of the gun within the field of view of the sight (such as a sight case, ammunition box, or stone) or a stake may be driven.

b. By use of an aiming point.—From a position in front of or in rear of the gun position, the observer selects an aiming point, preferably within a horizontal angle of 50 mils of the target to facilitate lateral adjustment since the deflection dial is graduated to 70 mils in each direction. The aiming point may be at a range greater or less than the range of the target. The observer must be able to see both aiming point and target. The gunner sees only the aiming point due to an intervening mask. The deflection dial is set at the deflection as read from aiming point to target and the vertical line of the collimator alined on the aiming point by manipulating the traversing mechanism. If the observer is near the gun position, the deflection read, aiming point to target, is the deflection to be applied on the sight. If the observer is in front (rear) of the gun position the deflection read will be greater (less) than the deflection to be applied on the sight. This correction factor varies as the ratio

$$\frac{\text{Distance observer-target}}{\text{Distance gun-target}}.$$

For example, if the observer is 200 yards in front of the gun, the range gun target is 800 yards, and the deflection read by the observer is 40 mils, the deflection to be applied on the gun is $\frac{600}{800} \times 40 = 30$ mils. However, it is seldom necessary to make

any except very approximate corrections since the observer is usually relatively near the gun, and unless the correction is computed very rapidly time is saved by opening fire and adjusting fire for direction.

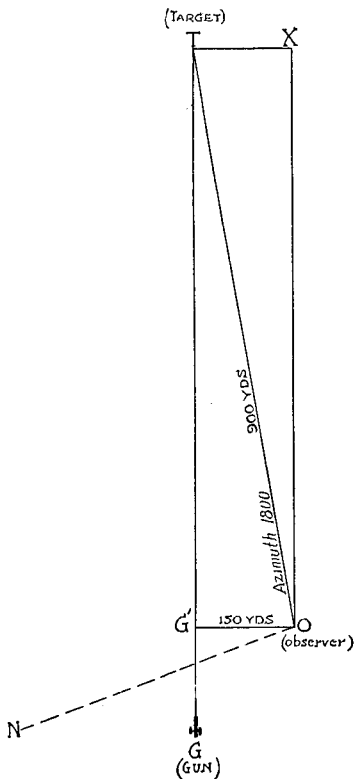

FIGURE 12.—Compass and mil formula method.

c. By compass and mil formula.—This method is applicable where the observer is off the line gun-target. The procedure is as follows:

(1) The observer reads the azimuth of the line observer-target.

(2) He then estimates the distance observer-target and the shortest distance from his position to the line gun-target.

(3) He divides the latter distance by $\frac{1}{1000}$ of the distance observer-target.

(4) He then corrects the azimuth read from his position by adding or subtracting the quotient of the above division. This will give the azimuth on which the gun should be laid. If the gun is on the left of the observer he adds the quotient to the azimuth observer-target. If the gun is on his right he subtracts.

Example: Azimuth O-T=1,800.

Distance O-T=900 yards.

Distance O-line G-T=150 yards.

$$\frac{150}{900} = 166.$$

.9

Correcting the azimuth of 1,800 mils by adding (gun on left) the 166 mils will give the azimuth gun-target $1,800 + 166 = 1,966$.

Discussion.—The observer *O* reads the azimuth *O-T* to be 1,800 mils, estimates the range *OT* to be 900 yards and the distance *O-G'* to be 150 yards. The azimuth *G-T* will be identical to the azimuth *O-X* (*O-X* constructed parallel to *G-T*). The correction necessary to be applied to azimuth *O-T* is equivalent to the angle *TOX*. The value of angle *TOX* is unknown. But angle *G'TO* equals angle *TOX*. (Alternate interior angles formed by a transversal cutting parallel lines are equal.) The value of angle *G'TO* can be determined by the mil formula $M = \frac{1,000W}{R}$. This formula is simplified for rapid practical use by dividing both numerator and denominator of the fraction by 1,000. Then

$$M = \frac{\frac{W}{1,000}}{\frac{R}{1,000}}. \text{ In this case } W \text{ equals } G'O, \text{ and } R \text{ equals } OT.$$

From figure 12 the azimuth of line *OX* is greater than the azimuth of line *OT*. But since the lines *OX* and *GT* are parallel the azimuth of line *OX* is the same as the azimuth of line *GT*, the desired azimuth. Therefore the correction must be added. A convenient method for teaching observers to know quickly whether the correction should be added or sub-

tracted is to use the word "LARS" (left add, right subtract); that is, if the gun is on the left of the observer "add," if on the right of the observer "subtract" the correction. A convenient method for determining the direction line for the gun is as follows: The gunner drives a stake at the gun position and rests a compass on it. He rotates the compass until the required azimuth is read against the index. The gun should not be at the gun position during this operation since the compass cannot be used within 30 feet of the gun as it will be affected by the mass of metal. He then directs another member of the squad to drive a stake on this line. The gun is set up at the stake on which the gunner rested his compass and the second stake is used as the aiming point.

d. By parallel line method.—This method is simple and rapid and in many cases accurate enough for field use. When the gun is in position and the observer is a short distance on either flank where he can see the target and the gun position the direction can be determined by the following method: The observer estimates the distance to a point on the line gun-target which is opposite him. He selects an object on the terrain which is on the same side of the line gun-target and at the same distance from the line gun-target as himself. With a compass he reads the magnetic azimuth from his position to the selected object. This is the azimuth on which the gun is to be laid and is transmitted to the gunner.

e. By stakes.—The observer goes to the hill or to a position where he can see both the target and the area in which it is desired to locate the gun, places himself as nearly as he can judge by eye on the line from the target to the area in which the gun is to be located, and drives a stake. He then moves toward the desired gun position, keeping the target and the stake in view. When he has moved back as far as possible without losing sight of the target, he drives a second stake in line with the first and the target. He moves back to the desired gun position and drives another stake in line with the two stakes he has driven to mark the exact position of the gun. The gun is set up at this stake with the sight bracket against or over it, and the gun is laid by sighting on either of the stakes in front of the gun with the deflection dial at zero. If the first two stakes are not visible from the gun

position the observer continues to move back, driving additional stakes on the line of the first two until he finally reaches the gun position. If woods intervene between gun and target this same method may be used, extending the line of stakes through the woods. In cases where the gun is in position and the observer is on higher ground in rear of the gun he has an assistant go to the front and directs him in driving stake on line gun-target. This method is comparatively slow. In practically all situations one of the more rapid methods can be used.

f. By back azimuth.—(1) *Gun position not fixed.*—When the target is not visible from the desired gun position the observer goes forward to a position where he can see the target and the area in which it is desired to locate the gun. He places himself, as nearly as he can judge by eye, on the line between the target and area in which the gun is to be located. He drives a stake, rests a compass on top of it, and reads the azimuth to the target. He then converts the azimuth to back azimuth. Having converted the azimuth to back azimuth, he moves to the opposite side of the stake and rotates the compass until he reads the back azimuth against the index. He then has another member of the squad drive a stake at the gun position on the line of back azimuth. The gun is set up at this second stake, and the stake on which the observer rested his compass is used as the aiming point. If the stake driven by the observer cannot be seen by the gunner, the observer has a stake driven between himself and gun on the line of the back azimuth. He then moves to this stake, rests the compass upon it, rotates the compass until he reads the back azimuth again, and has another stake driven between himself and the gun position. This operation is repeated until a stake can be driven at the gun position and another stake which can be used as an aiming point has been placed.

(2) *Gun position fixed.*—The observer places himself where he can see both gun and target and as nearly as he can estimate by eye on the line gun-target. He drives a stake, places a compass on top of it, and reads the azimuth to the target. He converts the azimuth to back azimuth, moves to the opposite side of the stake, and rotates the compass until he can

read the back azimuth against the index. He then sights along the line of back azimuth. If the line of back azimuth passes through the gun position the stake is exactly on the line gun-target and may be used as the aiming point if visible from the gun position. If the line of back azimuth does not pass through the gun position the observer must move to the right or left, again read the azimuth to the target, convert it to back azimuth, and sight back along the line of back azimuth. He continues to do this until the line of back azimuth passes through the gun position. If the observer's stake cannot be seen from the gun position he has additional stakes driven until one is visible. Time can often be saved by taking the first azimuth reading without the use of a stake. However, a stake should always be used as a support for the compass when taking or verifying the final reading. When the observer is provided with a compass which has sights that permit accurate alinement from front to rear, the compass can be used in the same manner as the alidade, and the azimuth need not be read or the back azimuth computed. This method is considerably faster and can be used with good results where a suitable compass can be obtained and where the compass can be rested on a steady mount of some kind.

g. By use of an alidade.—(1) *Gun position not fixed.*—The observer goes forward to the intervening crest as far as is necessary to see the target and takes a position from which he can see the target and the area in which the gun is to be located. He drives a stake on the line between the target and the area in which the gun is to be located. He places an alidade (or straight stick) on top of the stake. He alines the alidade accurately on the target, and then, sighting back over the alidade, indicates to a member of the gun squad the position at which a stake is to be driven which will mark the exact location of the gun. The assistant drives the stake where indicated. The gun is then laid for direction on the stake driven by the observer. If the stake driven by the observer is not visible from the gun position he has additional stakes driven by the assistant between his position and the gun position on the rearward line established by the alidade until a stake can be driven at the

gun position. Any one of the stakes between the gun and crest can be used as an aiming point. If the ground at the gun position is of such nature as to prohibit the driving of a stake the assistant lays the stake on the ground.

(2) *Gun position fixed.*—The observer goes forward to a position on the crest where he can see both target and gun position and places himself as closely as he can estimate by eye on the line gun-target. He drives a stake on this line and places an alidade on top of the stake. He alines the alidade accurately on the target and then sights back over the alidade. If the rearward line established by the alidade passes through the gun position the stake is exactly on the line gun-target and may be used as the aiming point. If the rearward line does not pass through the gun position the observer must move his stake to the right or left and repeat the operation of sighting first on the target and then to the rear until the alidade when alined on the target is alined also on the gun position.

h. By map and compass method.—In rare cases this method will be found applicable. The positions of gun and target are accurately plotted on a military map. The grid azimuth of the line gun-target is then measured with a protractor. This grid azimuth is then converted to magnetic azimuth and the gun laid on the magnetic azimuth obtained.

■ 87. **ELEVATION.**—A projectile fired from a gun does not travel in a straight line. It begins its flight along the line in prolongation of the bore at the moment of firing and under the influence of gravity it falls, describing a gradual curve. If a gun is pointed directly at a target and fired, the projectile will fall short of the target. Therefore to hit the target the gun must be pointed above the straight line connecting the gun and target (fig. 13). This line is called the line of site and refers to the site or location of the target and not to the sighting or aiming of the gun. All angles of elevation are measured from the line of site to the line of elevation. The angle of elevation is always the same for any given range whether the target is higher or lower than the gun. In laying a gun in elevation when the target is not visible some mechanical means is necessarily employed. The angle at which the gun is laid may be measured best

from the horizontal as the horizontal can always be established by the spirit level of the quadrant sight. Computation of the elevation data therefore consists of determining the angle at which it is necessary to lay the gun above the horizontal. The angle between the axis of the bore when the gun is laid and the horizontal is called the angle of quadrant elevation (abbreviated QE). When the gun is fired the projectile begins its flight on a line of departure which makes an angle of 5.3 mils with the line of elevation. This angle of 5.3 mils is called the angle of jump. The angle between the line of departure and the horizontal is called the quadrant angle of departure. The ranges and elevations given in the fire-control tables for this gun are based on angles of elevation used in actual firing. For this reason the use of the tables does not require any correction for jump. The angle of site may be a plus, a negative, or a zero angle of site, depending on whether the target is above, below, or on the horizontal through the gun position. The QE is always the algebraic sum of the angle of site and the angle of elevation (fig. 13).

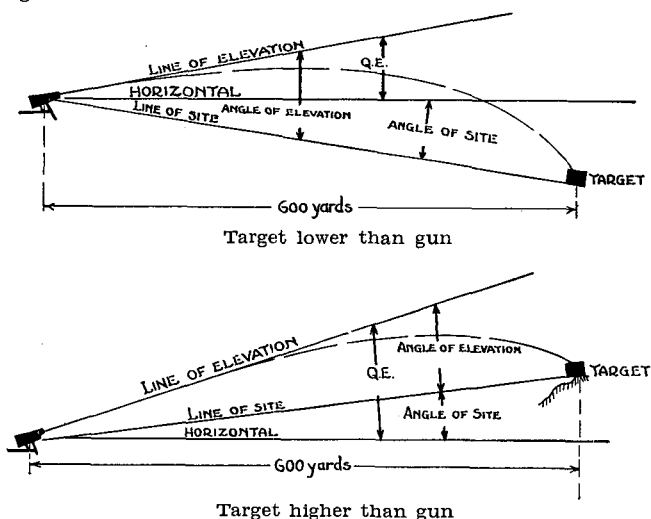

FIGURE 13.—Elevation.

■ 88. DETERMINATION OF ANGLE OF SITE OF TARGET.—The most accurate and convenient means of determining the angle of site of a target is by use of an angle-of-site instrument. If no instrument is available, the following method can be used with fair accuracy: The observer first locates a point near the target which is at the same level as his own position. If possible, this point is usually selected so as to appear directly above or below the target. He then estimates the vertical distance which he is above (below) the gun. By applying this vertical distance below (above) the point first selected, he can now locate a point which is approximately on the same level as the gun. The vertical angle in mils between the point last selected and target is then measured with the field glasses. The angle measured will be equal to, less than, or greater than the angle of site to be set off on the sight of the gun, depending upon whether the observer is the same distance, a greater distance, or a less distance than the gun is from the target. This measured angle varies from the angle of site to be applied on the sight as the ratio $\frac{\text{Distance observer-target}}{\text{Distance gun-target}}$

and may be corrected by applying this factor. The difference in elevation between the gun position and the observer will usually be so small in relation to the range that it can be ignored.

Example.—The observer is 200 yards in front of the gun, the observer is 10 yards higher than the gun. He selects a point near the target on the same level as himself. He selects a second point which he estimates to be 10 yards below the first point and measures with his mil scale the vertical angle between this second point and the target. He reads this angle second point to target to be 20 mils. Multiplying this reading by the factor $\frac{\text{Distance observer-target}}{\text{Distance gun-target}}$, he gets

$\frac{10}{12} \times 20 = 17$ mils, the angle of site to be applied on the sight.

If a map is being used in computing data the angle of site can be computed by the mil formula M equals $\frac{1000W}{R}$, in which M is the angle in mils, W is the difference in yards in elevation between gun and target, and R is the range gun-

target. The angle of site of a target is a plus, a minus, or a zero angle of site, depending on whether the target is above, below, or on the same level as the gun. Except for computing of very accurate data an angle of site of 5 mils or less is disregarded.

■ 89. DETERMINATION OF RANGE.—Range in most cases is estimated by eye. It may be determined by using a range finder if one is available, or may be determined from a map or by plotting. The more elaborate methods of determining range are slow and seldom of use in the field.

■ 90. LAYING GUN FOR ELEVATION.—The quadrant sight is so constructed that the QE of the target is computed mechanically. The procedure of laying the gun is as follows:

- a. Set angle-of-site dial at the angle of site of target.
- b. Set range dial with the graduation corresponding to range to the target opposite index on angle-of-site dial.
- c. Center bubble in level vial by manipulating elevating mechanism of the carriage.

Discussion.—Assume that a target has an angle of site of plus 10 mils and is at a range of 1,000 yards. The gun must be laid with a QE equivalent to 10 mils plus 1,000 yards. When the angle-of-site dial is set at plus 10 mils, its index is moved to the left. No other part of the sight is moved by this setting since the angle-of-site dial is a free moving part. When the 1,000-yard graduation on the range dial is set opposite the index on the angle-of-site dial, the level vial is moved through an angle which is the sum of the angle of elevation equivalent to 1,000 yards and 10 mils. The sum of the two angles in this case is (38 plus 10) 48 mils. When the bubble is centered as described in c above, the barrel is elevated 48 mils above the horizontal. Had the angle of site been minus 10 mils and the angle-of-site dial set accordingly, its index would have moved to the right. When the 1,000-yard graduation of the range dial is set opposite the index of the angle-of-site dial, the level vial is moved through an angle of (38 minus 10) 28 mils. When the bubble is centered by manipulating the elevating mechanism the barrel is elevated 28 mils above the horizontal.

■ 91. **MINIMUM RANGE.**—*a. Definition.*—Minimum range is the least range setting at which the projectile will clear the mask when the gun is fired from a given position on a target with a given angle of site.

b. Practical application.—(1) To determine the minimum range when the gun is first put in position the gunner must execute the following steps:

(a) Set range dial at the range to the mask with angle-of-site dial at zero.

(b) By turning elevating handwheel lay the gun so that the horizontal cross line of the collimator just clears the top of the mask.

(c) By turning range dial center bubble.

(d) Set angle-of-site dial at the angle of site of the target. Read minimum range on the range dial opposite index on angle-of-site dial and announce minimum range to the gun commander.

(2) The minimum range having been determined to be less than the range to the target, the gun commander then issues his fire order for indirect laying and proceeds to engage the target. When a target has an angle of site less than 5 mils, the angle is disregarded (except when data are very accurately computed) because it is extremely difficult for an observer to measure an angle of site within 5 mils without instruments.

(3) When changing from one target to another, the gun position not being changed, no change is made in the setting of the angle-of-site dial unless there is a difference of more than 5 mils between the angles of site of the two targets. When a new target is selected in the same direction as the previous target and the difference between the angles of site is greater than 5 mils, the gunner determines the minimum range as follows:

(a) Set angle-of-site dial at the setting for previous target.

(b) Set range dial at minimum range for previous target.

(c) Turn angle-of-site dial to the angle of site of new target and read minimum range.

Discussion.—When a mask such as a hill, wood, or heavy brush intervenes between the gun and target it is necessary to know whether the gun can fire over the mask and engage

the target. Assume a gun to be firing over a crest so that the projectiles will barely clear the crest without considering the gun as engaging any particular target. The trajectory may be considered fixed since the piece is fired with a fixed elevation (the one which barely clears the crest), and the projectiles continue their flight beyond the mask until they strike the ground (fig. 14 ①). The point at which they will strike the ground depends on the height of the ground, whether the ground rises, falls away, or is level. The slope of the terrain fixes the slope of the line of site which is expressed by the angle of site. When a particular target is engaged, the angle of site to be used is involved in the determination of whether or not a mask can be cleared because the angle of site is in reality the elevation of the target with respect to the gun and involves the slope of the terrain beyond the mask. It can then be said that the distance from the gun to the intersection of this lowest trajectory with the line of site is the least range which can be used from the given gun position with the given angle of site and have the projectile clear the mask. Figure 14 ①, ②, and ③ illustrates the effect which the slope of the terrain beyond the mask has on this least range. If it is known what elevation is required to clear a particular mask, then in reality it is known whether or not any given elevation will clear the mask. When indirect laying is employed, the piece is laid by the application of the angle of site and the range rather than by the direct application of the QE. Therefore the elevation required to clear a mask should be obtained in terms of range and angle of site. These two quantities are dependent on each other for their values in making up a given QE. For convenience one of them, the angle of site, is fixed for a given target. This is done by deciding to use a certain angle of site (the angle of site of the target being engaged) and then proceeding to determine the range which coupled with this angle of site will give the piece the proper elevation to cause the projectile just to clear the mask. In the operation of determining this least range which will clear a mask the piece is laid so that a round if fired would just clear the mask (1) (b) above. Then by manipulating the quadrant sight (centering bubble and setting angle of site) the elevation given the piece is measured in terms of yards

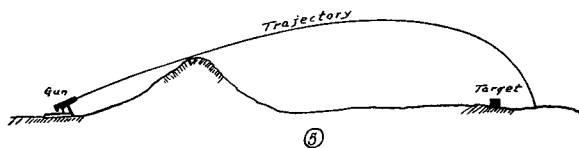
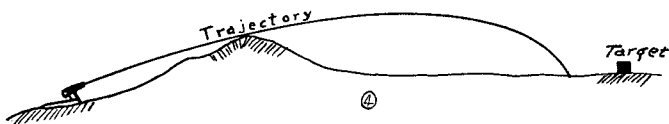
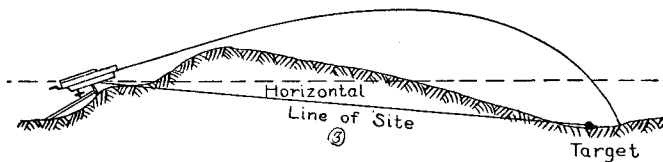
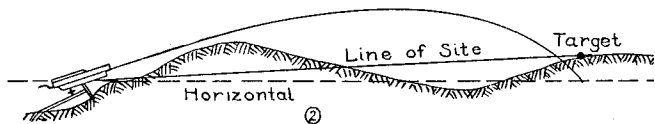
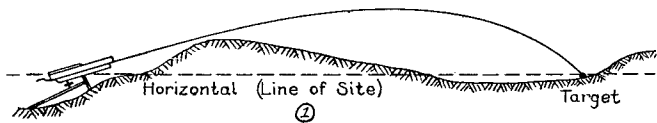

FIGURE 14.—Minimum range.

on the range dial. The reading found on the range dial after this operation is what is called the minimum range. If this range is less than the range to the target the target can be engaged. The gun can be given additional elevation above that necessary to clear the mask (fig. 14 ④). If the minimum range is greater than the range to the target the target cannot be engaged (fig. 14 ⑤). The gun cannot be given an elevation below that required to clear the mask because a lower elevation will probably cause the shell to burst on the mask. In this case it will be necessary to move the gun to a position where the minimum range will be less than the range to the target.

c. Precautions during firing.—When the minimum range has been determined the gun has the least elevation which will permit a projectile to clear the mask. It is mandatory that the gun commander exercise the greatest care that he does not order a range setting which is less than the minimum range. If he does order such a setting the gunner will inform him that the range he has ordered is less than the minimum range.

Example.—The minimum range has been determined as 650 yards. The first round fired with a sight setting of 750 bursts beyond the target. The gun commander, being intent on bracketing, orders a setting of 550 for the next round. The gunner informs him that the minimum range is 650. The gun commander then orders a round fired with a range setting of 650. If this round bursts beyond the target it is necessary that the gun be moved to a new position.

■ 92. USE OF TELESCOPIC SIGHT IN INDIRECT LAYING.—*a. Calculation of firing data.*—Since the telescopic sight is not equipped with an angle-of-site dial or spirit level the QE is necessarily calculated by the gun commander. With the quadrant sight this calculation is unnecessary as the data are computed mechanically. To determine the QE to be used proceed as follows: Estimate the range to the target. Refer to the range table and determine the angle of elevation which corresponds to the estimated range. Measure the angle of site. Add algebraically the angle of elevation and the angle of site. The result is the QE in mils. Again refer to the range table and determine the range in yards which

corresponds to this angle. This is the range to be set off on the sight when the gun is laid.

Examples:

No. 1.—The range to the target is estimated to be 800 yards and the angle of site is plus 10. The range table shows the angle of elevation for 800 yards is 28 mils. In this case both the angle of elevation and the angle of site are positive angles. Add the angle of elevation (plus 28) and the angle of site (plus 10). The sum is 38 mils which is the QE in mils. To convert this to yards refer to the range table which shows that 38 mils is the angle of elevation for 1,000 yards. When the gun is laid set off 1,000 on the range dial of the sight.

No. 2.—Assume the estimated range to the target to be 1,000 yards and the angle of site to be minus 10. The range table shows that the angle of elevation for 1,000 yards is 38 mils. In this case the angle of site is a negative angle. The algebraic addition of the two angles gives a QE of 28 mils. The range table shows that 28 mils is the angle of elevation for 800 yards. When the gun is laid set off 800 on the range dial of the sight.

b. Laying gun.—The telescopic sight can be used in indirect laying though its use in this manner is purely an emergency method and is ordinarily resorted to only when the quadrant sight is lost or broken. In using this sight it is necessary that the horizontal be determined in order that the QE may be measured therefrom. This result is obtained by means of a plumb line, the gun, and a stake. The rear face of the breechblock cap of the gun forms a right angle with the axis of the bore. Therefore when the rear face of the breechblock cap is vertical, the axis of the bore is horizontal. To lay the gun proceed as follows:

(1) Lay gun for direction.

(2) Hold a plumb line (which can be made by tying a stone to piece of string) against the rear face of the breechblock cap and raise or lower barrel by turning elevating handwheel until the rear face of the breechblock cap from top to bottom is in contact with the plumb line when the line is vertical. The rear face of the breechblock cap will then be vertical and the barrel will be horizontal.

(3) Set range dial at zero. When the sight is at zero the line of sighting is parallel to the bore. When the sight is at zero and the barrel is horizontal the line of sighting is also horizontal.

(4) Set out an aiming stake in front of the gun in such position that it is visible in the field of vision of the sight and slightly to the left of the vertical line when the deflection dial is at zero. Turn deflection dial until the vertical line is in line with the stake. The stake is set to the left to prevent the projectile striking it. It may be set to the right but left is preferable.

(5) Mark the stake where the line of sighting as established by the horizontal line of the sight intersects the stake. This marks the horizontal.

(6) Set off on range dial of the sight the range determined in the calculation of firing data. Bring the intersection of the cross lines on the mark on the stake by turning elevating and traversing handwheels. Since the gun has previously been laid for direction the movement of the traversing handwheel is slight, being merely enough to bring the intersection of the cross lines on the mark on the stake after the range has been set off on the range dial.

c. Determining least QE which will safely clear mask.—After the mark denoting the horizontal has been made on the stake as described in *b* (2) above, the least quadrant elevation which will safely clear a mask may be determined as follows:

(1) Set off range to mask on range dial.

(2) Lay the gun by means of the elevating handwheel so that the horizontal line of the sight just clears the top of the mask.

(3) Turn range dial until the horizontal line of the sight is alined on the mark on the stake.

(4) Read range on the range dial. This reading expresses in yards the least quadrant elevation which can be used and have the projectile clear the mask.

SECTION III
OVERHEAD FIRE

■ 93. GENERAL.—Since it will rarely be possible to fire through gaps in our own line, much of the support accorded to our troops is of necessity overhead fire; that is, fire directed over the heads of friendly troops. After consideration has been given to those factors which enter into all firing and which make it improbable or impossible for all shots to hit the exact spot desired, it is possible to lay down certain rules under which overhead fire can be employed with safety. Conversely, these rules determine when such fire is unsafe and is not to be employed. The factors to be taken into consideration to insure that all shots clear the heads of friendly troops are enumerated in order to show how safety rules are determined.

a. Dispersion of shot group.—(1) All other factors being disregarded, every shot does not follow the same path, due to errors in elevation of the gun, variations in the manufacture of ammunition and gun, condition of gun, and atmospheric conditions. These variations have been determined by test and the vertical and horizontal dispersion of the cone tabulated for all ranges. In addition to dispersion of the shot group which may be classed as mechanical, it is also necessary to consider the human element; that is, errors made by the gun commander in determining the following:

- (a) Range to target.
- (b) Range to troops.
- (c) Vertical interval between gun and target.
- (d) Vertical interval between gun and troops.

(2) If fire is adjusted, errors (a) and (c) are eliminated and (b) and (d) are greatly reduced since a gage for comparison is available in the target itself.

b. Safety clearance.—To insure safety of friendly troops it is necessary to have sufficient clearance between the lowest shot and the ground to allow for errors in range estimation, for the height of the men, for slight inequalities in the surface of the ground, and for an ample margin of safety. A table has been prepared which takes these factors into consideration and gives for each range minimum clearances of

the mean trajectory. For convenience these clearances are expressed in terms of the angles they subtend at the gun and are known as safety angles. Going a little further and assuming gun, troops, and target to be on the same straight line, if the angle of elevation of the range to the troops be added to the safety angle the result will be the minimum angle of elevation permissible when the troops are at the range indicated. This angle of elevation may be converted to a range in yards which is the least range permissible.

■ 94. OVERHEAD FIRE WITH DIRECT LAYING.—Direct overhead fire is that overhead fire which is delivered by employment of direct laying. Two distinct situations arise in delivery of direct overhead fire. One is where troops are stationary as in a defensive position, the other is where troops are advancing as in attack. Each situation requires a different method to determine whether overhead fire can be delivered and for what length of time.

a. Troops not advancing.—(1) Determine range to friendly troops.

(2) Find this range in column 1 of overhead fire table (par. 98).

(3) Find corresponding range on the same line in column 3 of overhead fire table. This will be the least range at which it is permissible to fire over the friendly troops in the position they are occupying at the time.

b. Troops advancing.—(1) Determine range to target.

(2) Find this range in column 3 of overhead fire table.

(3) Find corresponding range in column 1 of overhead fire table. This will be the range to which friendly troops can advance safely, and when they reach this range fire must cease or be lifted.

c. Rule of thumb.—(1) In cases where fire-control tables are not accessible the following rule of thumb based on the overhead fire table may be used:

(a) Set range dial at range to the target and lay gun on the target.

(b) Increase sight setting by 500 yards.

(c) Look through the sight and note point where the line of aim strikes the ground. If this point is ahead of the friendly troops it is safe to fire.

(2) Due to the fact that the greatest range graduation on the telescopic sight is 2,000 yards, this method is limited in application and should be used only in case no fire-control tables are available.

■ 95. OVERHEAD FIRE WITH INDIRECT LAYING.—Indirect overhead fire is that overhead fire which is delivered by employment of indirect laying. As in direct overhead fire separate calculations are made for troops which are stationary and troops which are advancing.

a. When troops are visible to the gunner and are not advancing the following method should be used:

(1) Determine range to troops.

(2) Set angle-of-site dial at the safety angle for troops at that range. (The safety angle may be found in column 2 of overhead fire table.)

(3) Set range to troops on range dial against index of angle-of-site dial.

(4) Lay horizontal line of the collimator on the troops with sight set as above by means of the elevating and traversing mechanism.

(5) Center bubble by turning the range dial without changing gun position.

(6) Set angle-of-site dial at the angle of site of the target.

(7) Read range on the range dial now opposite index of angle-of-site dial. This will be the least range at which it is safe to fire over the friendly troops. If the target is nearer than range shown on the range dial it is not safe to fire. It will be seen that this method is similar to the ordinary method of determining minimum range, except that the safety angle is set on the angle-of-site dial before the other operations are performed.

b. When the troops are not visible to the gunner and are not advancing the following method should be used:

(1) Measure angle of site of target.

(2) Determine range to target.

(3) Calculate QE for target.

(4) Measure angle of site of troops.

(5) Determine range to troops.

(6) Calculate QE for troops.

(7) Subtract **QE** of troops from **QE** of target. If the angular difference between the two is equal to or greater than the safety angle for troops at that range (see overhead fire table), it is safe to fire. If the angular difference between the two is less than the safety angle for troops at that range it is not safe to fire.

c. When troops are advancing the following method should be used to determine how far the troops can advance before it is necessary for the fire to cease or be lifted:

(1) Determine range to target.

(2) Find this range in column 3 of overhead fire table.

(3) Find corresponding range in column 1 on the same line. This will be the range to which troops may safely advance before fire must cease or be lifted when troops are on the line of site and the ground is level or has a uniform slope. When a hill or pronounced rise lies between gun and target on the ground over which the troops must advance, the troops will be nearer the trajectory than when the ground is level or has a uniform slope from gun to target. Therefore this rise in the ground is necessarily considered and calculation made to determine whether it will be safe to fire when troops are on the hill or rise in the ground. This is done by the same method as used when troops are stationary, using the hill or rise as the position of the troops.

■ 96. GENERAL RULES.—The following general rules will be observed in delivery of overhead fire:

a. Laying of gun will be checked carefully by the gunner before firing each round.

b. Target and limit of safety will always be visible to the observer.

c. Fire will cease or be lifted when troops reach the limit of safety.

d. When overhead fire is to be delivered from the time troops begin to advance, it will be determined whether it is safe to fire over them in their starting position. It is then necessary to determine how far they can advance before fire must cease or be lifted. Both calculations are necessary.

e. Required safety angles must not be lessened.

f. When practicable, friendly troops should be informed when overhead fire is to be delivered.

g. When practicable, depression stops should be used to prevent the muzzle being accidentally lowered below the limit of safety.

h. *Overhead fire is prohibited when troop distance is less than 400 yards, unless the difference in elevation of gun and friendly troops makes it perfectly evident that it is safe to fire.*

■ 97. DUTIES AND TRAINING OF GUN COMMANDER.—Delivery of overhead fire requires the highest degree of exactness and accuracy and no observer or gunner will be allowed to execute this kind of fire unless he is instructed thoroughly and is proficient in it. The gun commander is responsible for the rules of safety. When direct laying is employed the gun commander will be at the gun position and supervise the gunner's laying. When indirect laying is employed the gun commander, having determined the firing data, will take such position that he will be able to see the position of the friendly troops, the target, and the limit of safety. He will give the orders for opening and ceasing fire. He must understand thoroughly the rules for overhead fire and their application sufficiently well to repeat them without reference to written notes. He will be given practice in applying these rules to assumed situations. The instructor will conduct the observers receiving instruction in overhead fire to gun positions from which overhead fire is assumed to be delivered against targets indicated by the instructor. The instructor will explain the rules and then require the observers to determine whether or not it would be safe for the gun to fire if troops were at different positions along the line gun-target. The determination of the limit of safety will be checked by the instructor.

■ 98. OVERHEAD FIRE TABLE.—The table given below shows distances to troop positions, safety angles, and least permissible ranges. It is used as described in this section.

Table for overhead fire, high-explosive shell, Mk. II, muzzle velocity 1,276 f/s

(1) Troop distance	(2) Safety angle	(3) Corre- sponding range ¹	(1) Troop distance	(2) Safety angle	(3) Corre- sponding range ¹
<i>Yards</i>	<i>Mils</i>	<i>Yards</i>	<i>Yards</i>	<i>Mils</i>	<i>Yards</i>
400	23.5	925	1,000	24.9	1,450
500	22.4	975	1,100	26.6	1,575
600	21.3	1,050	1,200	28.2	1,675
700	21.3	1,125	1,300	29.8	1,775
800	22.1	1,225	1,400	31.7	1,900
900	23.3	1,350	1,500	33.7	2,000

¹ In even figures to the nearest 25 yards above the exact range.

SECTION IV

FIRE CONTROL AND ADJUSTMENT

■ 99. GENERAL.—Fire control is the regulation of fire by the gun commander. It enables him to bring fire on a designated target, to open and cease fire at will, to control the expenditure of ammunition, and to engage new targets. The gun commander controls fire by orders, commands, or signals which express the firing data to be used. When direct laying is employed he transmits the firing data by voice, as his position is at or very near the gun position. Whenever possible he will issue the firing data in the form of an oral fire order. In exceptional cases the gun commander may lay the gun himself or will give a detailed explanation to the gunner instead of issuing a formal fire order.

■ 100. FIRE ORDERS.—*a. Initial fire orders.*—(1) Initial fire orders (which contain the data for laying the gun for the first round) will contain the information shown below and will be given in the following sequence:

- (a) Type of shell to be used.
- (b) Angle of site (in case of indirect laying).
- (c) Range.
- (d) Deflection.
- (e) Aiming point.
- (f) Number of rounds to be fired.

(2) The words "type of shell," "deflection," "range," etc., are understood and not spoken.

Example.—Assume that an initial fire order for direct laying is to contain the following data: A high-explosive shell is to be used with a range of 900 yards and a deflection of zero; the aiming point is the base of a small pine tree directly to the front and one round is to be fired. The order would be expressed as follows:

HIGH EXPLOSIVE.

900.

ZERO.

TO YOUR FRONT, SMALL PINE TREE; BASE OF TREE.

ONE ROUND.

The deflection will always be announced, even if it is zero. Gunners and their assistants are trained to receive and execute fire orders in a fixed sequence and any variation or omission will cause delay and confusion. Unnecessary words are omitted. The command (so MANY) ROUNDS also indicates that the gun is to be loaded at once and to be fired when laid.

b. Typical fire order for indirect laying.—Assume that a high-explosive shell is to be used, that the target is 15 mils to the right of a natural aiming point which is the left edge of a lone pine tree to the front (deflection, right 15 mils); that the target has a minus 10 angle of site and a range of 1,300 yards; one round is to be fired. The fire order would be:

HIGH EXPLOSIVE.

MINUS 10.

1,300.

RIGHT 15.

TO YOUR FRONT, LONE PINE TREE, LEFT EDGE OF TREE.

ONE ROUND.

c. Subsequent orders.—Subsequent fire orders contain only the data which are to be changed and the number of rounds to be fired. To enable the observer to order the proper correction for errors in range he should remember the range with which the last round was fired because when orders are given orally, and when the signals used render it possible, he

commands the actual range setting to be set off on the range dial. It is not necessary for him to remember the last setting of the deflection dial because in making corrections he uses the last setting as a zero; in other words, he commands the correction to be made from the setting used for the preceding round.

Example.—The first round was fired with the deflection dial set at left 14 and the range dial set at 1,400; the observer wishes to fire the second round with a change which will move the burst 2 mils to the right and at a range of 1,200 yards; his fire order is:

1,200.

RIGHT 2.

ONE ROUND.

The gunner moves the deflection dial to left 12, the range dial to 1,200, and re-lays the gun. If it is desired to change only the range for the third round and the range desired is 1,300 yards, the fire order is:

1,300.

ONE ROUND.

If it is found that the range and deflection are correct, the observer may cause a number of rounds to be fired as, for example, five. The fire order is:

FIVE ROUNDS.

■ 101. ARM-AND-HAND SIGNALS.—*a. To shift right (left).*—Extend one arm toward the gunner(s) concerned; swing the hand and arm horizontally in the direction in which the fire is to be shifted, palm turned in that direction; with the palm of the hand toward the gunner(s), expose one finger for each mil the fire is to be shifted.

b. To increase (decrease) range.—Thrust the fist upward vertically from the shoulder to the full extent of the arm once for each increase of 25 yards; thrust it downward vertically in the same manner for each decrease of 25 yards.

c. To fire one round.—Extend one arm above the head toward the gunner for whom the signal is intended. Cut the hand sharply downward.

d. To fire five rounds.—Extend one arm above the head, hand open; flex the wrist, making a quick, choppy, lateral movement with the hand.

■ 102. TYPES OF FIRE.—Fire is divided into two types, fire for adjustment and fire for effect. Fire for adjustment is the type used to bring the center of impact on the target. It is described in paragraphs 104 and 105. Fire for effect is the type used to destroy, immobilize, or neutralize a target. It is delivered after fire has been adjusted. The number of rounds to be fired to effect the destruction of a target must be decided by the gun commander. Firing a small number of rounds in a series is better than firing the entire number of rounds in a group as it permits the observer to make slight adjustments and prevents wild shooting. To order fire for effect the gun commander commands; (SO MANY) ROUNDS. The command FIRE FOR EFFECT is not used.

Example.—A gun commander decides to use 15 rounds to destroy a target, fire having been adjusted. He commands FIVE ROUNDS and observes the bursts. He makes any corrections that he deems necessary and again orders FIVE ROUNDS. If satisfied, he again orders FIVE ROUNDS. The three series should follow each other without unnecessary pause. As the gun is used against definitely located targets and not to cover areas, traversing, searching, and oblique traversing are not standard classes of fire. There are no fixed commands for these classes of fire which, if desired in unusual cases, can be ordered by detailed instructions to the gunner.

■ 103. SENSING.—*a. General.*—When an observer senses a burst from a round fired he determines the deflection error; that is, how many mils the burst is to the right or left of the target, and whether it is an “over” or a “short”; that is, whether the burst is beyond or short of the target. He may be able to sense the round for deflection but not for range, in which case another round should be fired with the deflection correction applied and with the same range as the preceding round. In sensing a round the observer senses first for deflection and next for range.

b. Observer at gun position.—The best position for the observer is at the gun position. From this position his deflection sensing and the deflection correction to be made on the sight are the same. He can also exercise better control over the gun squad when at the gun position.

c. Observer in front or rear of gun position and on line gun-target.—Next to the gun position the best place for the observer is in front or rear of the gun position and on the line gun-target. However, from such a position his deflection sensing is not the same as the deflection to be set off on the gun. If he is in rear of the gun the deflection sensing will be less than the deflection to be set off on the gun; if he is in front of the gun the deflection sensing will be greater than the deflection to be set off on the gun (fig. 15). By practice the observer is able to determine the proper allowance to make. If he is halfway between the gun and target his deflection sensing will be twice the correction to be made on the sight; if the gun is halfway between the observer and the target his deflection sensing will be half the correction to be made on the sight; other distances will give other ratios (fig. 17). However, the observer usually will be close enough to the gun position to obviate the necessity of a correction for the distance of the observer from the gun.

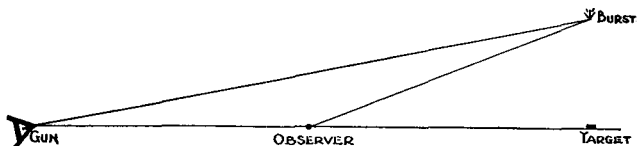

FIGURE 15.—Deflection sensing.

d. Observer to flank, to flank and forward, or to flank and rear.—(1) In each of these cases there will be an additional error due to the fact that the deflection sensing varies as the observer moves to the right or left; that is, the positions of the target and the point of impact with relation to each other seem to change as the observer changes his position.

Example.—In figure 16 the observer at *A* reads the actual deflection which should be set off on the sight. If he moves to *B* he sees the burst as if it were directly in line with the target. A correction for deflection is apparently unnecessary. If he moves to *C* he reads a deflection that is much greater than the correction to be set off on the sight. No formula has been devised which is satisfactory for use in the field.

(2) Upon taking a position off the line gun-target the observer should at once estimate where the line gun-target lies on the ground and read the deflection from this line to the bursts. As bursts having errors in range will appear to be to the right or left of the target, the observer should also estimate where a line perpendicular to the line gun-target and passing through the target lies. Having estimated where the line lies on the ground, the observer should consider all bursts between himself and this line to be "shorts," and all bursts on the far side of the line as "overs." An observer should always endeavor to avoid an observation post off the line gun-target.

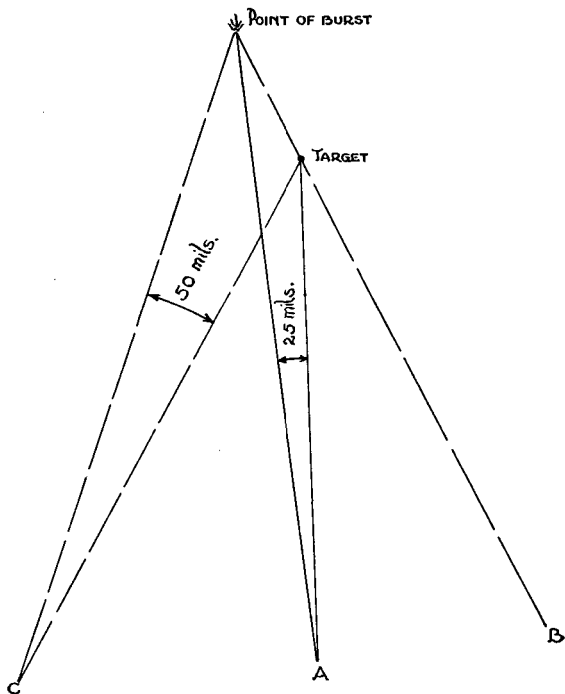

FIGURE 16.—Deflection sensings.

■ 104. ADJUSTMENT FOR RANGE.—Two methods are used in adjusting for range known respectively as bracketing and creeping methods. The bracketing method is used under almost all conditions. The creeping method may be used in overhead fire.

a. Bracketing method.—(1) The bracketing method is the one usually employed in adjusting fire. In this method the target is bracketed between an “over” and a “short.” The target is kept between two ranges, one increasing and the other decreasing, until the center of impact is on the target. A target is said to be bracketed when one “short” and one “over” have been obtained. Adjustment of fire by the bracketing method is executed as follows: The range to the target is estimated as accurately as possible and a round is fired with this setting. If the burst is observed to be an “over” the range setting is decreased 200 yards and another round fired with this new setting. If this is a “short” the third round is fired with a range setting which is the mean or average of the two previous range settings. Subsequent rounds are fired with range settings which are the mean of the last “short” and the last “over.” If the first burst is a “short” the range setting is increased 200 yards and another round is fired. Subsequent rounds are fired with range settings which are the mean of the last “short” and the last “over.” The distance from the target of the “short” or “over” is immaterial and need not be estimated or considered by the observer. After the bracket is obtained the range is increased or decreased in steps of 100, 50, and 25 yards, until the center of impact is on the target. If the bracket is not obtained by the second round, the range setting is again increased or decreased 200 yards and another round fired. Occasions when the bracket will not be obtained by the second round will be rare.

Example (fig. 17).—The range to the target is estimated to be 1,100 yards and the first round is fired with this setting. The burst is observed to be a “short.” The range setting is increased 200 yards and the next round is fired with a setting of 1,300. The burst is observed to be an “over.” The bracket is now established. The range setting for the third round is the mean of the “short” (1,100) and “over”

(1,300) and is fired with a setting of 1,200. The third round is observed to be an "over." The fourth round is fired with a setting of 1,150 which is the mean of the last "short" (1,100) and the last "over" (1,200). The fourth burst is observed to be a "short." The range for the fifth round is 1,175 which is the mean of the last "short" (1,150) and the last "over" (1,200). The fifth round bursts on the target. This may be verified by two additional rounds and fire for effect opened, or fire for effect may be opened without verifying rounds.

(2) Adjustments of less than 25 yards are used only when making a very fine adjustment of fire. As the probable error of the gun is about 25 yards at most combat ranges the dispersion will cover the target. Experience has proved that the bracketing method is the quickest, most accurate and economical method of adjusting fire. Attempts to estimate the distance between a burst and the target and to bring the next burst on the target are seldom successful due to the inability of observers to estimate accurately the distance between two points on the line gun-target. The bracketing method eliminates the necessity of doing this. The observer need determine merely whether a burst is a "short" or an "over." The method is applicable to practically all situations. Even when firing at a target on the crest of a hill the "shorts" can be observed and all unobserved bursts are treated as "overs."



FIGURE 17.—Bracketing method.

b. Creeping method.—(1) *General.*—This method is used when bursts must approach the target from but one direction (fig. 18). It is seldom used except in the adjustment of overhead fire when friendly troops are so close to the target that the bracketing method would be dangerous. In such case the first round is fired with a sight setting which will insure the burst being beyond the target; subsequent rounds are fired with sight settings which will insure that the shell do not burst short of the target. The creeping method is not

the normal method of adjusting fire and should not be used when the bracketing method can be used with safety. It is slower than the bracketing method and usually requires a greater expenditure of ammunition. The highly desirable feature of the creeping method is its factor of safety in certain situations, particularly in adjusting overhead fire.



FIGURE 18.—Creeping method.

(2) *Determination of initial range setting.*—The determination of the range setting to be used for the first round is important since it must burst on the desired side of the target. It is determined in the following manner: An “over” being desired in overhead fire, the observer estimates the extreme range to the target; that is, he estimates that the target is not more than a certain distance from the gun. He then uses a range setting which is greater than this extreme estimated range.

Example.—Friendly troops are close enough to the target to render bracketing unsafe. The observer estimates that the target is 1,000 yards from the gun and certainly not more than 1,100. He uses 1,100 as the base and adds 100 to make certain that the first round will burst beyond the target. He orders a range of 1,200 for the first round.

(3) *Adjustment of fire.*—The error of every burst must be estimated when adjusting fire by the creeping method. The first round is fired with a range setting which will insure the burst being on the desired side of the target which in the usual case, overhead fire, is the far side. The observer estimates the amount of the error in yards and halves it. If the first burst was an “over” as intended, the halved error is deducted from the initial range setting and a round is fired with the new range. The error of the second burst is estimated, halved, deducted, another round fired. This is continued until the center of impact is on the target when fire for effect is opened. If at any time a burst is obtained on the wrong side of the target, the next round is fired with a change equal to half the change made for the last observed round.

Example.—The gun commander is delivering overhead fire. He estimates that a range setting of 1,350 will insure the first burst being beyond the target, and fires a round with that setting (fig. 18). He estimates the burst to be 300 yards beyond the target. Half of this error is 150 yards. He deducts 150 from 1,350 and fires the next round with a setting of 1,200. He estimates the burst of the second round to be 100 yards beyond the target. Half of this error is 50. He deducts 50 from 1,200 and fires the third round with a setting of 1,150. He estimates the burst to be 100 yards beyond the target. He deducts 50 from 1,150 and fires the fourth round with a setting of 1,100. The burst is observed to be a "short" (on the wrong side of the target). The observer makes a change equal to half the change made for the previous round (which was 50) and fires the fifth round with a setting of 1,125. It bursts on the target. This is verified by two additional rounds, found to be correct, and fire for effect is opened.

■ 105. ADJUSTMENT FOR DEFLECTION.—The observer should have the zero of the horizontal mil scale of his glasses trained on the target before the shell bursts. The deflection error is sensed at the instant the shell bursts. If this is not done sensing may become difficult owing to the smoke cloud being blown to one side or dissipated. The deflection error as sensed is immediately changed to a deflection correction and given to the gunner in an adjustment order.

Examples.—*No. 1.*—The burst of a shell is sensed as 14 mils left of the target. The observer orders RIGHT 14, thus moving the next burst 14 mils to the right. The observer orders the actual correction to be made regardless of the reading on the deflection dial.

No. 2.—The gunner has made the correction previously ordered, and the deflection dial is set at right 14. A round is fired and the observer senses the burst to be 3 mils left of the target. He orders RIGHT 3. The gunner sets the deflection dial at right 17, thus giving the gun additional 3 mils deflection to the right. Another round is fired and the observer senses the burst to be 1 mil right of the target. He orders LEFT 1 and the gunner sets the deflection dial at right 16. The gunner re-lays on the aiming point after each change of sight setting by turning the elevating and traversing handwheels.

SECTION V

FIRING AGAINST MOVING TARGETS

■ 106. GENERAL.—*a.* Due to the slow and limited traverse and lack of power to penetrate heavy armor plate, the use of the 37-mm gun, M1916, against moving targets such as heavily armored tanks and cars is not contemplated. If necessary to employ the gun against light armored tanks and cars, the method shown below may be used.

b. The methods usually employed for firing on point targets are too slow for this type of fire. Because of the target's ability to make changes of direction and speed it is necessary for the observer to make estimates of angular speeds and to announce changes of deflection and range which will keep the fire on the target. The method employed can best be described by outlining the duties of the various members of the squad during firing.

■ 107. OBSERVER.—The observer has the problem of target designation, range and deflection estimation, fire orders, adjustment, and control of fire. Based on time of flight of the high-explosive shell, Mk. II, the following time factors are used for certain key ranges as indicated below:

Key ranges.....(yards) ..	400	800	1,200	1,600	
Time of flight of shell					
	(seconds) ..	1.1	2.3	3.7	5.2
Time factors.....do....		1	2	4	5

a. When the target appears the observer quickly designates the target to the gunner by as simple a designation as possible. He then quickly estimates the range to the target and observing the target through his glasses reads the angular movement in mils which the target makes while he is counting the number of seconds; that is, time factor for the key range which is nearest his estimated range to the target. This angular movement in mils is then given in his fire order as right or left deflection.

b. The fire order used for point targets has been found too slow for use against moving targets. The best results have

been obtained by using a fire order with the elements in the sequence as follows:

TARGET (DESIGNATION).

RANGE.

DEFLECTION.

Example.—A tank appears in the zone of fire of a gun. The observer immediately designates the target to the gunner who, if necessary, moves the trails of the gun and points the barrel in the direction of the tank. In the meantime the observer, having estimated the range to the target, is reading the angular movement during a time factor which corresponds to the estimated range to the target. He reads this movement by aligning the zero of his horizontal mil-scale on the tank, then holding the glasses as still as possible counts the proper number of seconds. This is done very quickly and accuracy improves greatly with practice. Assume that a tank appears in the right of his sector at a range of 900 yards and he reads the angular movement during two seconds to be left 12 mils. His fire order would be as follows:

TO YOUR RIGHT FRONT, THAT TANK.

900.

LEFT 12.

His adjustment order for the second round based on his sensings for the first round includes merely the corrections in deflection and range. Deflection changes for the second and succeeding rounds must be based not only on errors in direction as determined from sensing each previous round but also must be based on changes of direction and speed of the target. Proficiency in estimating deflection changes to compensate for changes of speed and direction comes as a result of much training. It is impracticable to adhere strictly to the 200-yard bracket since in doing so the essential element of rapidity of fire may be sacrificed. When a burst is obtained near the target a range change of 50 or 100 yards usually will give the proper correction since the height of the target increases the probability of a hit over that of a low target.

■ 108. **SIGHT SETTER.**—The sight setter is an addition to the gun crew used in firing on point targets. His position is on the left of the gun where he can quickly manipulate the sight

dials. The addition of the sight setter to the crew has been found from experimental fire to increase the rate of fire from 20 to 25 percent, since in relieving the gunner of this duty the latter can give his entire time to tracing the target. The sight setter repeats each element of the fire order and adjustment orders as they are given, and applies the corrections in deflection and range to the sight. As soon as an announced change or setting has been applied to the sight by him he calls "check" so that the gunner may know that the change has been accomplished.

■ 109. GUNNER.—The gunner's chief duty is to keep the cross lines of the sight laid on the target and preferably on the front end of the target by manipulation of the elevating and traversing handwheels. Only by keeping his eye at the sight and by constant manipulation can he accomplish this. The most important factor in speeding up fire is teamwork of the sight setter and the gunner. When the gunner hears a change of deflection or elevation announced by the observer he may anticipate the corresponding movement of the cross lines in the sight when the correction is applied thereto by making a slight change in laying to right or left or higher or lower by manipulation of the traversing or elevating handwheel.

Example.—If, while tracing a target moving from left to right during the firing of a problem, he hears the command RIGHT 5 he knows that when the correction is applied to the sight the vertical cross line will move slightly to the left. He compensates for this movement of the cross line by laying immediately a short distance ahead of the target. When the correction has been applied the cross line will again be on or near his aiming point on the target. At any time that he is laid on the aiming point and the gun is loaded he calls "fire," not waiting for a command of execution from the observer.

■ 110. ASSISTANT GUNNER.—The assistant gunner's chief duties are to load and to fire the gun on command of the gunner. As soon as the breech is opened the assistant gunner should immediately reload and be prepared to fire the instant he gets the gunner's command to fire.

■ 111. PREPARATORY TRAINING.—*a.* Preparatory training may be accomplished by "dry" shooting on an automobile first

driven across the front at a right angle to the direction of fire at ranges from 400 to 800 yards, and at speeds from 10 to 20 miles per hour. The observer is required to estimate the range and deflection lead and to give a fire order. The instructor then calls out errors in direction and range for each shot and requires the observer to give adjustment orders; these corrections are applied to the sight by the sight setter and the gunner continuing to trace the target calls "fire." Fire is simulated by the assistant gunner calling "on the way." The assistant gunner then opens the breech and loads a dummy round or simulates loading. Assume that the initial fire order given was—

THAT CAR.

500.

RIGHT 8.

and that the first round was fired with these data applied to the gun, the instructor then announces to the observer the assumed sensings of the burst, for example, 3 LEFT, OVER. The observer then gives his adjustment order based on the announced sensings. "Dry" shooting is especially essential to the training of the gunner. It requires a considerable amount of practice for him to be able to keep the gun laid on the target. It is also essential to the development of smooth teamwork between the sight setter and the gunner.

b. Later the automobile should be driven at different angles to the line of fire with varying speeds and with changes of direction that will require deflection leads from left to right and vice versa. When the angular movement of the target changes from right to left or from left to right of the line of fire the observer should command ZERO and make a new estimate of the angular speed and announce the new deflection.

■ 112. EQUIPMENT FOR TRAINING.—*a. Target.*—A sled of the type shown in figure 19 has proved to be the most satisfactory kind of target. It has the advantage of a low center of gravity which prevents upsetting on rough ground and in making changes of direction. The sled shown in the figure is 5½ by 3½ by 4½ feet high and weighs only 45 pounds. Figure 20 shows a similar sled covered with target cloth. In firing on this type of target it must be borne in mind that there will

be no target bursts when hits are made but adjustment must be made from bursts beyond and short of the target.

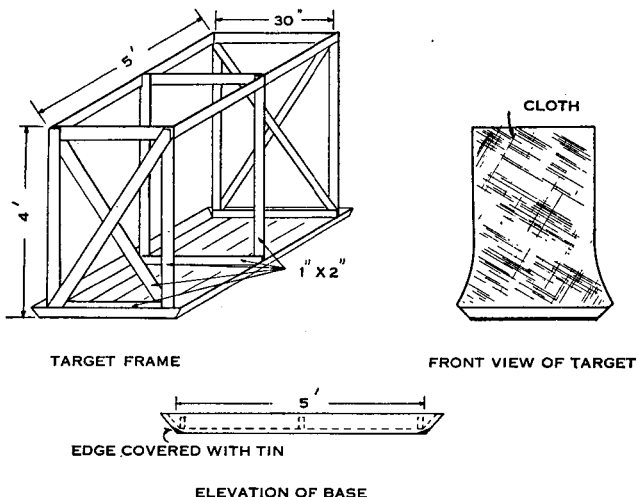

FIGURE 19.—Target frame for moving target range.

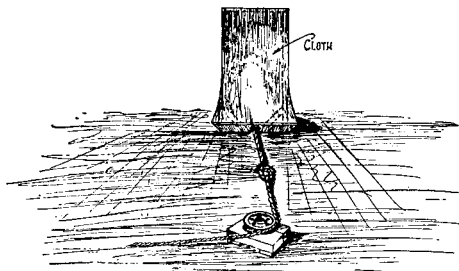
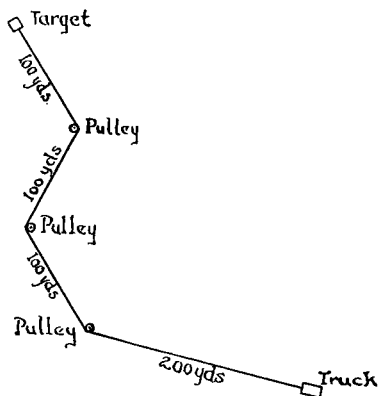

FIGURE 20.—Sled target covered with target cloth; pulley and trip knot for effecting changes of direction.

b. Towing.—For towing the target a $\frac{1}{2}$ -inch rope has been found satisfactory, the power being furnished by a $1\frac{1}{2}$ -ton truck. The pulley shown in figure 20 is simply a channel wheel bolted to a short length of 2-inch board. This board is staked to the ground at a point where a change of direction

of the target is desired. The knot shown in the figure should be 10 or 12 feet from the sled, depending on the speed at which the target is to be run. At faster speeds the knot must be at a greater distance from the sled to prevent the increased momentum of the sled from overrunning the pulley.

c. *Set-up*.—With 500 yards of rope a set-up as shown in figure 21 can be made. This set-up is only one of many possible to make with 500 yards of rope. The one safety factor necessary is to keep the truck not less than 200 yards from the line of fire. Accidents incident to wrong laying may be prevented by keeping just in rear of the gun a safety officer whose duty is to see that the barrel is kept pointed in a direction not too near the truck. The essential elements in training a gun squad to fire at moving targets are much practice for the observer in estimating angular speeds and for the gunner in laying on a target in motion, and for everybody, *speed*.



• GUN
FIGURE 21.—Set-up for towing a target.

SECTION VI

OTHER FIRING METHODS

■ 113. **FIRING AT TARGETS IN TREES.**—The target is the aiming point during fire for effect. The following steps are necessary:

- a.* Estimate range to tree in which target is located.
- b.* Set deflection dial at zero and range dial at estimated range to tree.
- c.* Lay intersection of cross lines on base of tree by turning elevating and traversing handwheels.
- d.* Adjust fire until center of impact is at base of tree.
- e.* Move intersection of cross lines to target in tree by turning elevating and traversing handwheels, and fire for effect. The deflection and range dials are not touched after fire has been adjusted on the base of the tree.
- f.* In cases where it is necessary to employ indirect laying the following steps are necessary:
 - (1) Adjust fire on base of tree.
 - (2) Read vertical angle between base of tree and target.
 - (3) Increase setting of angle-of-site dial by value of vertical angle read.
 - (4) Reset range dial at the last range used in adjustment of fire.
 - (5) Fire for effect.

■ 114. **FIRING AT TARGETS IN BUILDINGS.**—The method given in paragraph 113 can be used in adjusting fire on targets located in buildings, particularly where the buildings are of such construction as to allow the shells to pass through the wall before bursting, thus rendering the burst invisible to the observer. Fire is usually adjusted at the intersection of the building and the ground and the cross lines then shifted to the target by turning the elevating and traversing handwheels.

■ 115. **NIGHT FIRING.**—The gun may be required to fire at night. In such cases the data for firing are determined beforehand, an aiming point which can be seen at night (called a night-firing device) is set up, and the gun is laid to hit the target. Precautions are taken to prevent enemy

observation of the flash, and only fire for effect is delivered at the proper time during the night.

a. Determination of firing data.—Because of the small danger radius of the shell the gun is not suitable for firing against areas. Hence the firing data must be exact. Such data are best obtained by actual firing during daylight. It is not desirable to adjust fire directly on the target since it may be a machine-gun position or other similar target occupied only at night. Direct adjustment of fire would give the enemy advance information of our intention. Therefore it is preferable to adjust fire on a point about 50 mils or more to the right or left of the target and at the same range. Fire is adjusted by single rounds fired at long intervals so that the enemy's attention will not be drawn to the gun position. Full advantage should be taken of any artillery firing, the sound of which will muffle the sound of the gun.

b. Laying gun.—After fire has been adjusted on the selected point the gun is laid so that the projectiles will strike the target. This is done by measuring the horizontal angle between point and target, setting off the angle on the deflection dial, and re-laying on the aiming point.

Example.—The deflection dial upon the completion of fire for adjustment on the selected point is at right 5. The observer finds by measurement that the target is 50 mils to the right of the point upon which he adjusted fire. The deflection dial is then set at right 55 and the gun re-laid on the aiming point which was used during fire for adjustment. The gun has thus been laid so that the projectiles will strike the target. The horizontal angle between the target and the point on which fire is adjusted can be read very accurately by means of the vertical line and deflection dial of the telescopic sight.

c. Use of night-firing device.—To check laying during night firing an aiming point which is visible to the gunner must be used. Such an aiming point visible in darkness is known as a night-firing device. After the gun has been laid so that the projectiles will strike the target the night-firing device is set up in front of the gun in such position that it is visible in the field of vision of the telescopic sight. The gunner should glance through the bore to make certain that the device will not be struck by a projectile when the gun is fired.

The cross lines are then moved to the aiming mark on the night-firing device by turning the deflection and range dials. The settings of the dials are noted and recorded. Care must be exercised that the gun is not moved when moving the cross line; the elevating and traversing handwheels must not be touched. The telescopic sight is more suitable for night firing than the quadrant sight. During firing the gunner checks the laying by alining the cross lines on the visible aiming mark. Since it is difficult to determine during fire for adjustment whether the target and the point on which fire was adjusted are at exactly the same range, it is advisable to lengthen artificially the beaten zone to insure the target being struck. This can be done by depressing and elevating the barrel slightly during fire for effect; a quarter turn of the elevating wheel up and down will be sufficient. A slight amount of traversing should also be carried out; a quarter turn will be sufficient in most cases. The gunner should re-lay on the aiming point at every fourth or fifth round.

*d. Concealment of gun position during firing (fig. 22).—*To prevent the exact location of the gun being determined by the enemy the flash of the gun must be concealed as far as possible. This is accomplished by means of the flash hider and screens made of burlap sacks or canvas. The flash can thus be hidden from all places which are not directly in front of the gun and will make it extremely difficult to determine its exact location. While the flash hider does not conceal the flash it does reduce the illumination of objects at the gun position. Frequent inspection must be made during fire for effect to see that the blast of discharge has not forced the flash hider off the barrel. Screens should be placed as shown in figure 22 (care being taken to allow for traversing the gun) and also in front of the gun above the muzzle in order to conceal the flash from any enemy that may be located on higher ground. Screens should be dampened to prevent their ignition by sparks. The night-firing device also must be hidden from enemy observation.

e. Removal of gun.—It may be desirable to remove the gun between fire for adjustment and the time that fire is to be delivered at night. In such case, in order that the fire for effect may be accurate the gun must be replaced in the exact

position from which fire was adjusted. This can be effected by driving short stakes at each trail spade and at the front leg float (or wheels) before the gun is removed. The gun is returned to the exact position marked by these stakes, the deflection and range dials set at the recorded settings, and the cross lines laid on the aiming point by turning the elevating and traversing handwheels. The night-firing device is left in position when the gun is temporarily removed.

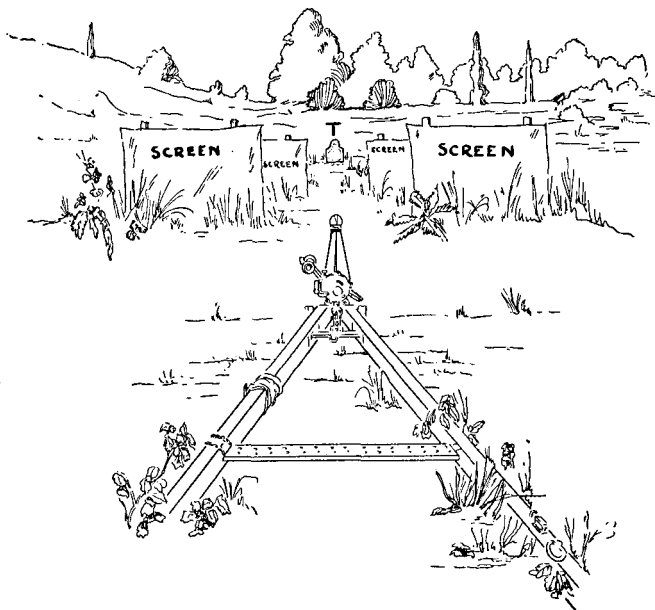

FIGURE 22.—Concealment of gun.

f. Construction of night-firing device.—Night-firing devices can be improvised in several ways. In the end of a tin can or box cut a cross-shaped slit and cover it with a thin white cloth to keep the glare out of the gunner's eyes. Or remove the lid of a can, mark a heavy black cross on a sheet of paper, and fasten the paper over the open end. Punch several holes in the other end of the can. In one side of the

can cut a rough cross-shaped slit and bend its edges inward to admit and hold a candle. Punch several nail holes above and on each side of where the flame of the candle will be. A candle is lighted and inserted, and the night-firing device set up in front of the gun. The cross lines of the sight are alined on the cross of the can. A flashlight may be used for illumination if one is available.

■ 116. FIRING WITHOUT SIGHTS.—*a.* The gun is not rendered useless because of loss or destruction of the sights. A quarter turn of the elevating handwheel will move the point of burst about 200 yards at ordinary combat ranges, and a quarter turn of the traversing handwheel will make a change of about 10 mils in direction. The following is an example of the approximate elevations above the line of site for the gun firing the high-explosive shell (M. V. 1276 f/s) expressed in terms of the elevating handwheel:

	<i>Yards</i>
One-half turn.....	750
One turn.....	1,200
One and one-half turns.....	1,600

b. The trail spades must be driven firmly into the ground before the gun is laid, otherwise the sinking of the trail spades during the first few rounds will affect the elevation of the gun.

c. To lay the gun for the first round, the gunner opens the breech and by means of the elevating and traversing handwheels moves the gun until the target can be seen when glancing along the bottom of the bore. He then elevates the gun by turning the elevating handwheel the number of turns (or fraction thereof) which will give the gun an elevation corresponding approximately to the range to the target. Holding both handwheels firmly, he orders a round fired.

d. To adjust fire the gunner observes the burst, turns the handwheels an amount which he believes will make the necessary correction, holds the wheels firmly, and orders another round fired. He continues to do this until the center of impact is on the target. Fire for effect is then delivered. The gun commander with his field glass observes the effect of the fire and assists the gunner in any way possible.

■ 117. LONG-RANGE FIRING.—When occasion demands firing on a target at a greater range than the highest graduation on the sight the procedure given below is followed:

a. Target visible to the gunner, telescopic sight used:

(1) Estimate range to target.

(2) Refer to range table and determine angle of elevation which corresponds to estimated range.

(3) Subtract 73 mils (angle of elevation for 1,600 yards) from angle of elevation for estimated range.

(4) Refer to range table and determine range equal to the difference found.

(5) Set range dial at 1,600.

(6) Lay intersection of cross lines on target by means of the elevating and traversing handwheels.

(7) Set a stake in front of the gun within the field of vision of the sight.

(8) Set range dial at zero. This raises the horizontal cross line and thus raises the line of sighting 73 mils above the line of site. The axis of the bore is also 73 mils above the line of site.

(9) Mark the stake where the line of sighting intersects it. This is the new aiming point.

(10) Set range dial at range determined in (4) above.

(11) Lay intersection of cross lines on mark made on the stake by manipulating elevating and traversing handwheels. Adjust fire in the usual manner.

b. Target not visible to the gunner, quadrant sight used:

(1) Estimate range to target.

(2) Measure angle of site.

(3) Refer to range table and determine angle of elevation which corresponds to estimated range to target.

(4) Subtract 73 mils from angle of elevation.

(5) Refer to range table and determine range equal to the difference found by the foregoing deduction.

(6) Lay gun for direction.

(7) Set range dial at 1,600.

(8) Center bubble by turning elevating handwheel.

(9) Set a stake in front of the gun in the same manner as when direct laying is employed.

(10) Set range dial at zero.

(11) Mark the stake where the line of sighting intersects it. Use horizontal line of collimator to determine this point.

(12) Set angle of site of target on angle-of-site dial.

(13) Set on range dial range determined by calculation.

(14) Place intersection of vertical and horizontal cross lines of collimator on mark made on the aiming stake by turning elevating and traversing handwheels. Disregard spirit level of the sight. When the quadrant sight is used in laying the gun for long-range firing the extreme-range setting of the sight may be used since the cross lines of the collimator are not limited in the same manner as the cross lines of the telescopic sight. However, for the sake of uniformity and to fix thoroughly a definite range setting (with its corresponding angle of elevation) in the minds of gun commanders, it is preferable to use 1,600 for both sights.

SECTION VII

RANGE CARDS

■ 118. GENERAL.—*a.* In order to be prepared to deliver fire promptly on likely targets in a situation data which will facilitate laying of the gun during hours of both good and limited visibility must be determined immediately after occupying a position. These data must be determined to all key points at or near which targets may be expected such as crossroads, ridges, stream junctions, woods, and other landmarks. The targets may include areas which may be occupied by the enemy. The data must also be recorded in a form which will serve as a guide to the leaders and gun crew, and a range card for each gun is used for this purpose. It is in the form of a sketch of the sector showing only the probable locations of targets and the data as to direction and range necessary to place fire on them.

b. The employment of range cards allows decentralization of command without loss of fire control. Range cards are also of great value in planning the coordination of defensive fire. Duplicates of the original range cards prepared during the occupation or consolidation of a newly occupied position are collected by platoon leaders. With the addition of such brief explanatory remarks as may be necessary these reports form a valuable source of information as to location and field

of fire of the gun. Such early reports enable the platoon commander to inform the battalion commander exactly what the gun can do in the event of hostile action and indicate where coordination and rearrangement are necessary.

■ 119. PREPARATION OF RANGE CARDS.—*a.* Range cards will be prepared on strong paper or cardboard. Waterproof ink or ordinary soft lead pencil will be used. Ordinary ink and indelible pencil will blur when wet and will not be used. All lines will be made heavy and clear, and all letters will be printed since the card must be read often in a very dim light. One copy of each range card will be sent to the platoon commander and one copy retained in the personal possession of the gun commander. The card at the gun position will be secured to a stake or board and placed in position where it can be read easily by the gun commander. It will be protected by a waterproof covering which will allow ready reference to the card.

b. No fixed form of range card is prescribed, but the following description of the various steps in preparing a range card will facilitate instruction in this subject. To prepare a range card proceed as follows:

(1) Select a piece of strong paper or cardboard. Represent on this by a point the position of the emplacement (fig. 23 ①).

(2) Draw a line through this point parallel to the bottom of the paper. This is known as the base line. Using the point (gun position) as a center, draw semicircles to represent ranges of 500, 1,000, and 1,500 yards (fig. 23 ②).

(3) Turn the paper until the base line is parallel to the front of the gun position and without again moving the paper draw a line in the direction of the most prominent, centrally located object in the field of fire. This object need not be within the range of the gun nor need it be a target or probable target. This line is known as the zero line and is drawn heavier than other lines. Determine the range to this object and mark it on the card in its proper relative position (fig. 23 ③).

(4) Without moving the paper draw lines to other points which are targets or at which targets are likely to appear. Mark these places in their proper relative positions on the

card. All prominent features on the ground which will facilitate determination of ranges to targets which may appear near these points should be shown (fig. 23 ④). Mark the nature of the targets such as "machine gun," "sniper's post," etc.

(5) Determine as accurately as possible (by map, range finder, or firing) ranges to all points shown on the card. Determine angle of site of each point. Read magnetic azimuth of each point. Mark the data on the range card (fig. 23 ⑤). Mark the direction of magnetic north, the number of the emplacement for which the card is prepared, and the date on which it was made. Number all points from right to left. Numbering these points permits the platoon commander to order fire on "point number ——" without further description (fig. 23 ⑤). Each range card should be accompanied by a data sheet on which are recorded the location and nature of targets, the time and nature of their activities, and any other data which will assist a relieving gun crew.

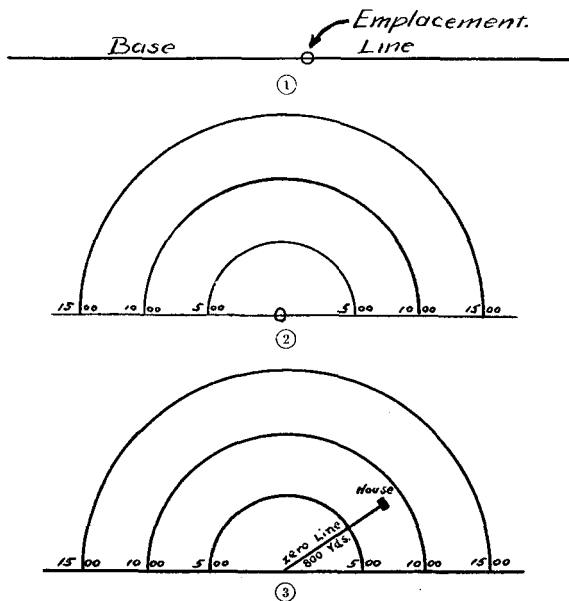

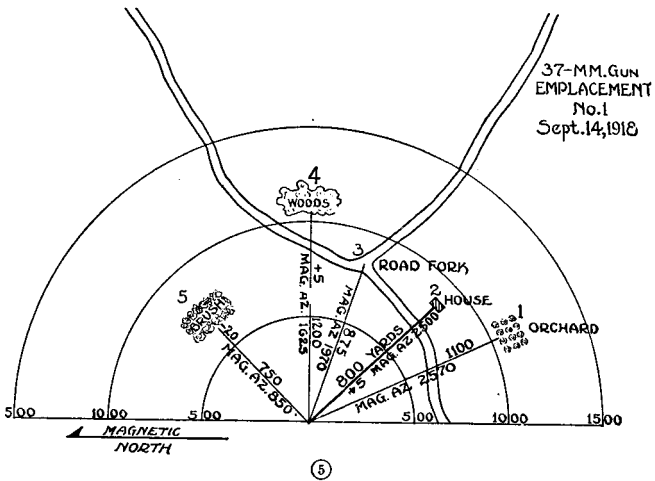
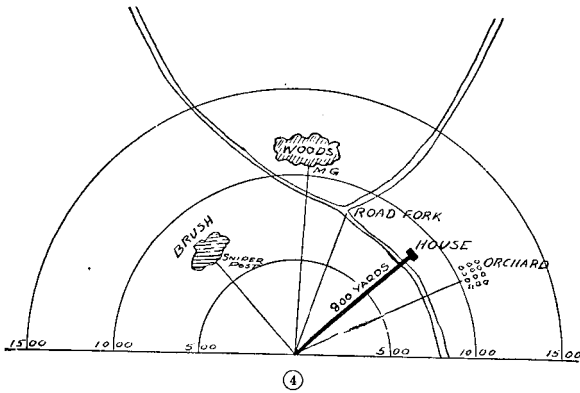

FIGURE 23.—Preparation of range cards.

CHAPTER 5

FIRING AT FIELD TARGETS

	Paragraphs
SECTION I. General	120-122
II. Preparatory exercises.....	123-126
III. Firing exercises.....	127-135

SECTION I

GENERAL

■ 120. **PURPOSE.**—The purpose of this phase of training is to further instruct leaders in the control of their units under simulated battle conditions, and the individual soldier in the performance of his duties as a member of a fighting team so as to secure the maximum fire efficiency.

■ 121. **BEFORE UNIT RECEIVES TRAINING IN FIRING AT FIELD TARGETS.**—*a.* All men should be given instruction in mechanical training, drill, marksmanship, and the technique of fire.

b. All officers, noncommissioned officers, and a few selected privates should be given instruction in the care and operation of fire-control instruments.

■ 122. **SCOPE.**—Training in firing at field targets will include instruction in range estimation, selection and occupation of positions, use of cover and concealment, and firing exercises.

SECTION II

PREPARATORY EXERCISES

■ 123. **GENERAL.**—*a.* Before a unit is presented a field firing exercise it should receive preparatory instruction. This instruction may include conferences, demonstrations, and practical work using nonfiring exercises. These exercises are valuable because they eliminate to a great degree the question of safety and allow the troops to give undivided attention to the instruction.

b. Officers conducting preparatory exercises receive valuable experience. They learn quickly to present and conduct exercises, to judge solutions and to conduct critiques. They may give their entire attention to these important points by elimination of the distraction caused by enforcing necessary safety precautions when ball ammunition is used.

■ 124. RANGE DETERMINATION.—Effectiveness of gun fire depends largely on range estimation. In firing exercises economy of time and ammunition is greatly enhanced by correct range determination. It is therefore advisable during this phase of instruction to review the methods of range determination described in paragraph 51c.

■ 125. SELECTION OF GUN POSITION.—a. Selection of a gun position is governed by the mission, field of fire, cover and concealment while firing, routes of approach, fire control, and time available for occupancy.

b. These factors may be pointed out in a demonstration showing several different positions and discussing the favorable and unfavorable points of each position.

c. This should be followed by exercises in which the instructor designates a number of possible gun positions and requires the men to choose one of the positions designated and state the reasons for their selection. The advantages and disadvantages of each position are discussed to insure that the men consider all of the important factors before deciding which position to occupy.

■ 126. USE OF NATURAL COVER AND CONCEALMENT.—a. When a gun can be located definitely by the enemy it is soon put out of action. It is necessary therefore that the gun crew take advantage of all natural cover and concealment available both in approaching and in occupying the gun position.

b. During training in the use of cover and concealment the unit should be divided into a number of small groups. Two groups should work together as a team, one group selecting and moving into gun positions while the other group acts as observers. On completion of the exercise the observers discuss the actions of the men of the group that occupied the positions and point out the errors that were made.

c. When an exercise is finished the groups change places and another exercise is solved. By conducting the training in this manner the men learn to occupy gun positions while under observation and many of the small errors which usually disclose the location of a position are eliminated.

d. In training men in the use of natural cover and concealment the following will be stressed:

(1) Unnecessary movement after getting into position will be eliminated.

(2) Shiny articles or sharply contrasting colors will not be worn.

(3) Steel helmets will be camouflaged so as to break the regular curved outline of the helmet.

(4) When crawling into a position in sight of the enemy move straight toward him. Do not move sideways or zigzag.

(5) When crawling keep the body well down. Do not let the arms and legs wave around.

(6) Avoid quick or jerky movements.

SECTION III

FIRING EXERCISES

■ 127. UNITS TO FIRE.—Each gun squad will engage in field firing exercises when local facilities permit.

■ 128. TERRAIN.—*a.* The availability of ground and consideration for safety determine the selection of terrain for field firing. Where possible, ground providing varied natural targets at ranges between 500 or 1,500 yards is desirable.

b. In the absence of other facilities a known-distance range may be used by arranging the exercises so that they begin off the range and require delivery of fire on the range and in a safe direction.

■ 129. TARGETS.—Field targets may be improvised from available material or they may be obtained from the Ordnance Department.

■ 130. SAFETY.—*a.* AR 750-10 states the general safety measures to be observed when firing live ammunition in peacetime.

b. The officer in charge of a field firing exercise is responsible for the safe conduct thereof. He will insure that the guns are not loaded or firing begun before the range is clear. He will also see that the direction of fire conforms to local requirements for safety, and that firing ceases immediately upon appearance of a signal from the pits.

■ 131. COMMUNICATION.—*a.* The officer in charge of a field firing exercise will take the necessary steps to insure proper communication on the range.

b. On extemporized ranges the communication between firing positions and other parts of the range may be by temporary wire lines, by flags, by rocket signals, or by bugle signals.

■ 132. ADMINISTRATIVE ARRANGEMENTS.—*a.* Instruction in field firing requires ranges, equipment, and supplies that must be prepared or obtained in advance. The time required for this preparation will depend largely on conditions and facilities at the post or camp where the instruction is to be given.

b. Necessary supplies and ranges will be requisitioned early enough to prevent any interruption in the training schedule.

■ 133. FIRING EXERCISES.—*a. Exercise No. 1.*—(1) *Purpose.* (*a*) *For the leaders.*—Practice in the control of the fire of their units by fire orders in order to engage properly the various types of 37-mm gun targets.

(*b*) *For the men.*—The application of the principles of technique of fire, use of individual cover and concealment, operation of means of communication, and ammunition supply.

(2) *Unit.*—One 37-mm gun squad.

(3) *Situation.*—The squad or platoon is deployed, gun position has been selected but the gun is not yet in position to fire.

(4) *Method.*—A suitable target is pointed out to the leader, who issues the necessary orders for placing the gun in position, opening fire on the target, and for fire adjustment. Fire for effect is not a part of these exercises. As soon as fire for adjustment has been accomplished, the positions of the crew are changed, a new target selected and the exercise repeated.

Initially each type of target is presented in a separate exercise. When the men have completed a simple exercise engaging each type of target, exercises are conducted of a similar type in which one or more surprise targets appear so that it is necessary to shift a part or all of the fire of the unit to engage them.

b. Exercise No. 2.—(1) *Purpose.*—(a) *For the leaders.*—Practice in the selection of firing positions, conducting the unit forward by covered routes, issuing orders for the occupation of the initial firing positions, fire orders and fire control.

(b) *For the men.*—Movement into the initial firing position and its occupation with the minimum of exposure—application of the principles of technique of fire.

(2) *Unit.*—One 37-mm gun squad.

(3) *Situation.*—The squad is halted under cover.

(4) *Method.*—The initial targets are indicated to the platoon leader. The platoon leader determines the general location in which the 37-mm guns should be placed, sends for the squad leaders, and directs that the platoon move forward to a location nearby. Upon the arrival of the squad leaders, the platoon leader issues his order assigning targets and general locations for the squads. The squad leaders reconnoiter for definite gun positions, conduct their units forward under cover and issue their orders for the occupation of firing positions. The guns are placed in position under the supervision of the platoon leader and the squad leaders. From this point on the problem is conducted in a manner similar to that described in *a* above.

■ 134. **CRITIQUE.**—At the completion of all exercises the instructor should conduct a critique covering the following points:

a. Use of cover and concealment.

b. Actions of platoon leader and section and squad leaders in getting their units on the ground without delay.

c. Reconnaissance by platoon leader and section and squad leaders.

d. Orders of—

(1) Platoon leader.

(2) Section leaders.

(3) Squad leaders.

e. Suitability of firing positions.

f. Fire action of unit (all elements of technique used in delivering fire).

■ 135. AMMUNITION.—The ammunition for this firing will be taken from the combat allowance.

CHAPTER 6

ADVICE TO INSTRUCTORS

	Paragraphs
SECTION I. General.....	136-138
II. Mechanical training.....	139-142
III. Gun drill.....	143
IV. Marksmanship.....	144-145
V. Firing at field targets.....	146-151
VI. Instruction on the sand table.....	152-153

SECTION I

GENERAL

■ 136. **PURPOSE.**—The provisions of this chapter are to be accepted as a guide and will not be considered as having the force of regulations. They are particularly applicable to emergency conditions when large bodies of troops are being trained under officers and noncommissioned officers who are not thoroughly familiar with approved training methods.

■ 137. **ASSISTANT INSTRUCTORS.**—A sufficient number of non-commissioned officers and selected privates should be trained in advance for use as assistant instructors during the training of the remainder of the organization.

■ 138. **DEMONSTRATION GROUPS.**—A small group of men, usually four to six, should be trained in advance to demonstrate exercises while the instructor is making the explanation. They should be rehearsed carefully in the duties they are to perform so that when they do present a demonstration it is correct in every detail and gives a clear picture of the work under discussion.

SECTION II

MECHANICAL TRAINING

■ 139. GENERAL.—*a.* The unit to be instructed should be divided into groups of four men each. Each group under the direct supervision of an assistant instructor and with its own gun or set of equipment should be assembled in a suitable area.

b. The instruction is centralized under the unit instructor. Explanation and demonstration are concurrent, each assistant demonstrating the elements of the particular phase of instruction as the instructor explains it from the platform. For short periods of practical work the instruction is decentralized under the assistant instructors.

■ 140. DESCRIPTION.—*a. Equipment for each group.*

37-mm gun, complete (on wheels).

Rammer.

Telescopic sight, M1916.

Quadrant sight, M1916.

b. Procedure.—(1) Have assistant instructors point out each part as the instructor names it.

(2) Require the men to point out and name each part.

■ 141. FUNCTIONING.—*a. Equipment.*—Instruction in functioning of the gun and ammunition is greatly facilitated by the use of charts. Group equipment will consist of the 37-mm gun, complete. Whenever practicable, the various types of service ammunition should be shown so that the men will become familiar with their appearance.

b. Procedure.—(1) The instructor explains the functioning of the part and assistant instructors point out and manipulate the part named.

(2) The men are required to explain the functioning as described by the instructor.

■ 142. CARE AND CLEANING.—*a. Equipment.*—37-mm gun, complete, gun and cradle with empty recoil cylinder and oil gun.

b. Interest in the care and cleaning of the gun and accessories may be stimulated by comparing it to any other piece of machinery. Operators of large fleets of motor vehicles,

one of the largest of which is the army, have a definite procedure for preventive maintenance. The care and cleaning of the gun is a similar procedure designed to prevent failures of the gun.

c. This period should include a demonstration of the method of filling the recoil cylinder prescribed in paragraph 9.

d. A conference accompanied by a demonstration of the points to be observed before, during, and after firing should prove valuable.

SECTION III

GUN DRILL

■ 143. GUN DRILL.—*a.* In the presentation of instruction in drill, demonstrations should be used freely. A demonstration unit of selected, previously trained men is formed. Individuals or units to be instructed are arranged so that the demonstration unit can be seen plainly. The instructor explains that the demonstration unit accompanying his description of the movements will go through the movements very slowly, step by step, like a slow-motion picture. He cautions individuals undergoing the instruction to watch the demonstration unit and to imitate the movements as demonstrated.

b. Units (usually squads) are then formed with their equipment by the assistant instructors who require them to perform the movements demonstrated. Each movement is first executed step by step until the assistant instructor is satisfied with the performance of each man. Men are frequently rotated in the various squad positions.

c. The equipment necessary for each group is described in chapter 2.

SECTION IV

MARKSMANSHIP

■ 144. GENERAL.—Instruction in marksmanship should follow mechanical training and drill. In marksmanship the element of speed has been added to exactness in performance of the duties of the various members of the gun crew covered in the instruction exercises. The instructor must assure himself

that each assistant thoroughly understands each exercise, is accurate in his explanations, and is insistent upon the exact performance of each sequence. The importance of exactness must be impressed upon the men at all times. For example, men in setting the sight in the sight-setting exercise are apt to say: "That is about right." There is no such thing as a sight that is about right; it is right or it is wrong. Once the habit of exactness is formed, speed follows as a matter of course. The equipment and arrangements of same for each test are described in chapter 3. The instructor divides the unit to be tested into groups of from four to eight men, depending on the equipment available and the size of the unit undergoing instruction. When practicable, squad leaders act as assistant instructors in charge of each group. The groups contain the members of the squad leaders' own squad to be tested, plus a proportionate number of the unit overhead. In case it becomes necessary to use noncommissioned officers or selected privates who are required to take the test they should be tested with the first group in order that they may be free to conduct the instruction.

■ 145. PROCEDURE.—*a.* Assistant instructors require each individual of their group to perform each of the tests described in paragraphs 63 to 72, inclusive.

b. They check each performance in the same manner as described for the board conducting the tests.

c. They mark the progress of each man on the progress chart shown in section I, chapter 3.

d. They report to the senior instructor when the members of their group are ready to qualify.

e. The senior instructor supervises the group instruction, notes the progress of the individuals on the group charts, and requests the board to meet when a sufficient number of men are ready to be tested.

SECTION V

FIRING AT FIELD TARGETS

■ 146. GENERAL.—*a.* During the early part of preliminary instruction in field firing, demonstrations are useful for teaching the technique of troop leading.

b. All firing exercises should be prepared carefully and thoroughly. The situations and requirements should be simple. Complicated exercises confuse the participants and do more harm than good.

c. Before preparing a firing exercise the author should make a personal reconnaissance of the terrain to be used for the exercise. In all exercises and demonstrations emphasis should be placed on terrain.

■ 147. SEQUENCE OF TRAINING.—*a.* A minimum of 28 hours of instruction should be devoted to this phase of training. The schedule of instruction should be divided into training periods. Each period should be from 3 to 4 hours in length.

b. The following is a suggested minimum course:

(1) *First period.*—Preparatory exercise. Range estimation.

(2) *Second period.*—Preparatory exercise. Use of natural cover and concealment.

(3) *Third period.*—Preparatory exercise. Selection of gun positions.

(4) *Fourth period.*—Preparatory exercise. Demonstrations, movement to and occupation of firing positions.

(5) *Fifth period.*—Field firing exercise.

(6) *Sixth period.*—Field firing exercise.

(7) *Seventh period.*—Field firing exercise.

(8) *Additional periods.*—Additional time available should be devoted to exercises involving selection of and occupation of initial firing positions and advance to subsequent positions.

NOTE.—During the above period of field firing training instruction in firing against moving targets as prescribed in paragraphs 106 to 112, inclusive, should be given wherever applicable.

■ 148. USE OF NATURAL COVER AND CONCEALMENT.—*a.* During training in the use of natural cover and concealment the unit should be divided into an equal number of small groups. Two groups should work together as a team, one group selecting and moving into gun positions while the other group acts as observers. On completion of the exercise the observers discuss the actions of the men in the group that occupied the positions and point out the errors that were made.

b. When an exercise is finished, the groups change places and another exercise is solved. By conducting the training

in this manner the men learn to occupy gun positions while under observation and many of the small errors which usually disclose the location of a position are eliminated.

■ 149. PRELIMINARY INSTRUCTION.—*a.* During the conduct of some of the preparatory exercises part of the requirement of the exercises should be the actions and orders of the squad leader. In such exercises all the corporals and certain selected privates should be required to solve the requirement for the squad leader.

b. During preparatory exercises the personnel within the platoon should be changed frequently so as to give each man as much training and experience in the next grade above him as possible.

■ 150. SELECTION OF GUN POSITIONS.—*a.* During instruction in the selection of gun positions every man should be required to act as the squad leader.

b. When teaching the selection of gun positions for the attack, the instructor may use an exercise in which he designates a number of possible gun positions and requires the men to choose one of the positions designated and state the reasons for their selection. As each possible gun position has certain advantages or disadvantages over each other possible position, the instructor insures that the men are considering all of the important factors in selecting gun positions before deciding which position to occupy.

■ 151. CRITIQUE.—*a.* The basis of good instruction in field firing is intelligent, tactful, and constructive criticism. In his critique conducted after each exercise the instructor discusses the solution offered and makes a comparison with other possible solutions. The critique should be given on the ground used for the exercise.

b. The instructor should commend that which was well done and call attention to that which was poorly or incorrectly done. Where errors have been committed a correct solution should be indicated. In making corrections the instructor should avoid ridicule, sarcasm, or any remarks which might be harmful to morale or initiative or which might lead to a dread of assuming responsibility in the minds of the men.

c. The critique should not convey the impression that there is but one correct method of solving the exercise. Such a misconception is apt to lead to the adoption of fixed forms, an attempt to guess what the instructor wants, and a resulting destruction of initiative and independent thought.

SECTION VI

INSTRUCTION ON THE SAND TABLE

■ 152. PLACE IN TRAINING.—The sand table offers an effective means of teaching certain phases of technique and combat principles. Exercises in conduct of fire, selection of gun positions, and the use of cover can be adapted readily to the terrain of the sand table. This type of instruction is particularly valuable during inclement weather or when facilities do not permit the use of adequate terrain. It engenders an

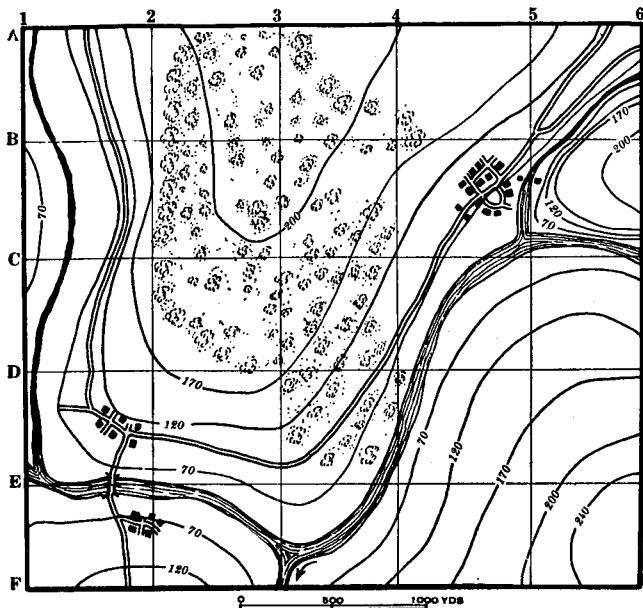

FIGURE 24.—Map to be reproduced on sand table.

appreciation for terrain by presenting terrain features and dispositions so that the pupil may view them perspectivevly. The various kinds of sand tables used in teaching military subjects may be compared mainly according to simplicity of construction. It is not necessary in teaching small units to use elaborate models nor is it desirable. Simple reproductions may be changed easily and frequently to present a variety of situations.

■ 153. PREPARATION OF SAND TABLE.—*a. Description of equipment.*—The box or tray is first constructed. The one shown in figure 25 is made of 2-inch lumber. It is 10 feet long by 5 feet wide and 10 inches deep. It is a large table and can be used not only for small problems involving squads, platoons, and companies, but also for problems involving units the size of a regiment. The construction of the box can be deduced from the figures illustrating this paragraph without further explanation. The inside of the completed box should be tarred to prevent warping. The box is filled with sand obtained from local sources. Any kind of sand capable of being molded when wet will suffice. The following additional

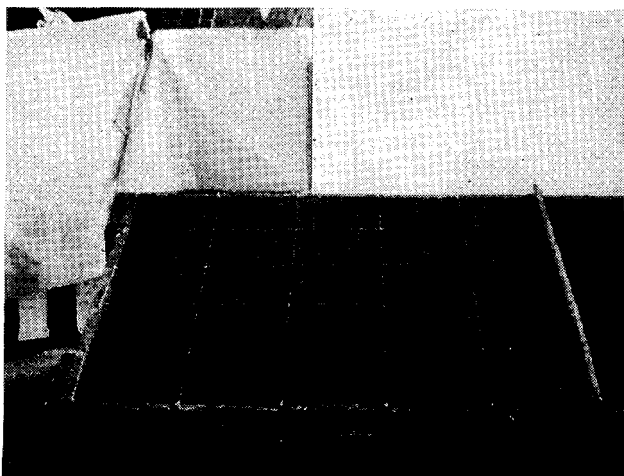

FIGURE 25.—Sand table divided into squares to correspond with map.

equipment will facilitate the construction of models: Shovel, rake, sprinkling can, ruler, large can of water, bucket for mixing sand and water, string, thumbtacks, blue and green colored chalk, road rollers, a small wire sieve for powdering chalk, and assorted sizes of wooden blocks to represent buildings.

b. Determination of scale.—(1) Suitable terrain is selected on a map. The section of map is marked off and divided into squares which are numbered and lettered as shown in figure 24. Since the section of map selected is square and the sand table is 5 feet wide by 10 feet long, only one-half of the sand table is used for this example. The map has been divided horizontally and vertically into 25 squares. Figure 25 shows the sand table divided into 25 squares. Each square on the map will represent 1 square foot on the sand table. Before molding the sand to conform to the map it is necessary to establish the datum plane and the vertical interval for the sand table. The datum plane is the origin for all vertical measurements. In this case it is the top of the table. The vertical interval of the sand table is the number of feet of vertical interval on the map which corresponds to 1 inch on the sand table. For example, the highest point on the map is in the lower right-hand corner and the contour shows its elevation to be slightly more than 240 feet. The lowest point on the map, about 60 feet, is on the stream bed. Their difference is 180 feet. In order to allow a margin at the bottom of the table, 6 inches is selected as the desired depth of the terrain. Since 6 inches represents 180 feet, 1 inch will represent 30 feet, that is, a vertical distance of 1 inch on the sand table represents a vertical distance of 30 feet on the map.

(2) The area represented in the lower right-hand corner of the map will be built level with the top of the sand table and the stream bed will be 6 inches below the top of the sand table. To determine the height of any point on the sand table, place a straight edge across the top of the table, then place a ruler against this straight edge and measure down the desired number of inches. This number can be determined readily. For example, select a point on the 150-foot contour.

The difference between the elevation of this point and the highest point on the map is 90 feet. Applying the conversion factor, 1 inch represents 30 feet, the elevation of this point on the sand table is 3 inches below the top of the table.

(3) The next step is to determine the horizontal scale. The map is 3,300 yards wide. It is to be reproduced on one-half of the sand table, that is, in an area 5 feet square. Therefore, each linear foot on the sand table will represent 660 yards on the map.

c. Construction of terrain.—(1) The first step in constructing the terrain is to outline the most prominent geographical feature, in this case the stream bed. This is done by tracing in the sand with the fingers the outline of the stream bed as shown in figure 26. The next step is to outline in a similar

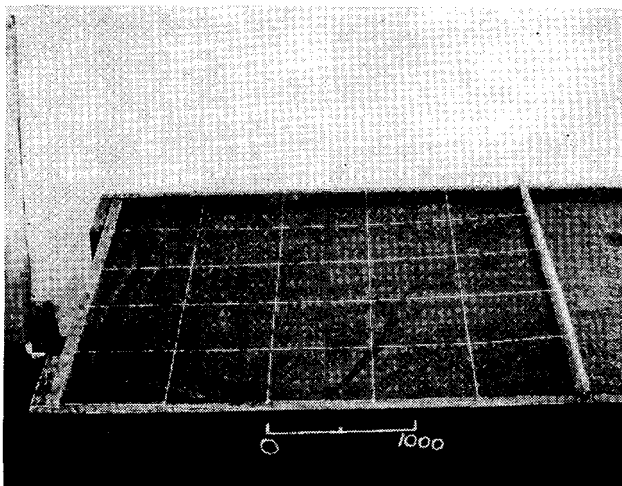

FIGURE 26.—Stream bed outlined in the sand.

manner the principal contours. In figure 27 a 120-foot, a 170-foot, and a 240-foot contour have been outlined. Next mold the sand. In doing this care should be taken to bring out clearly the ground forms. This can be done rapidly. It

is not necessary that every portion of the sand table be accurate to a fraction of an inch. It is only necessary that the ground forms be correct in general. (See fig. 28.) This molding should take about 30 minutes.

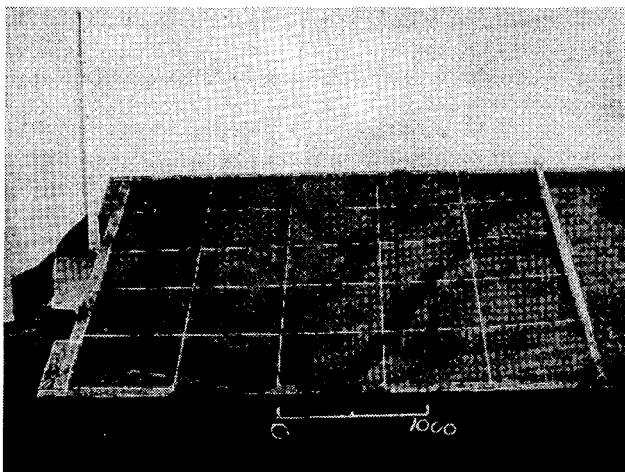

FIGURE 27.—Principal contours outlined and molding begun.

(2) The terrain features now assume definite shapes. In figure 28 all of the ground forms are completed. Next use a piece of paper to smooth out the inequalities of the sand. (Sprinkling water over the sand with the sprinkling can will secure much the same results.) One-half of the sand has been so smoothed. The other half has been left rough in order to show clearly the difference between the smooth and the untouched parts. When molding of the sand has reached this stage, the work is almost completed.

(3) Next line off the prominent roads. Rollers of the type shown in figure 29 can be used for this purpose. Then drop in the woods. To do this drop small handfuls of wet sand on the table in their proper places. Color the woods with powdered green chalk, outline the stream with powdered blue chalk. Powder the chalk by rubbing over a small wire sieve.

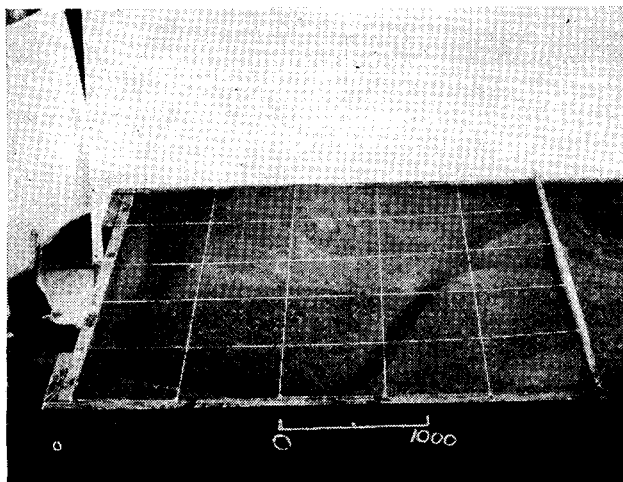

FIGURE 28.—Molding completed. Half of sand smoothed with paper.

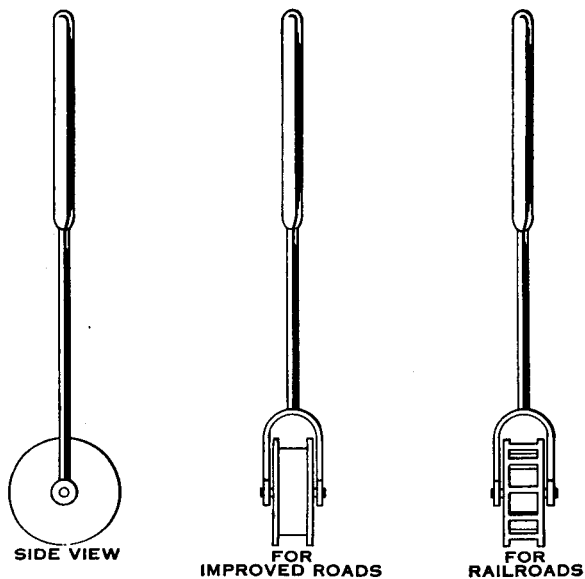

FIGURE 29.—Type of rollers.

Use the wooden blocks to indicate the villages; place in the bridges, take off the string, and the table is finished. (See fig. 30.) The whole construction should take no longer than an hour.

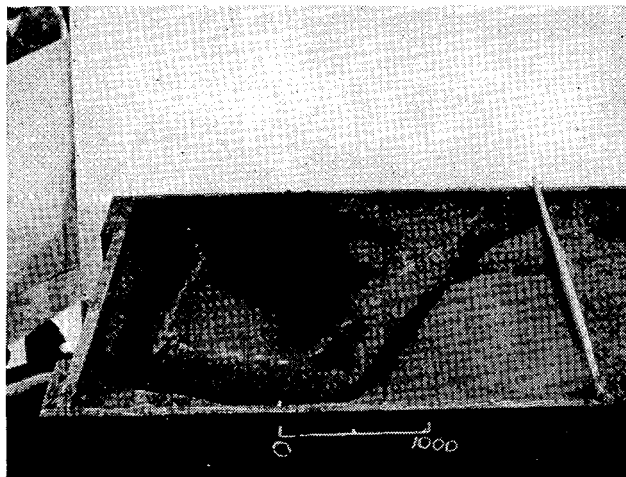

FIGURE 30.—Completed sand table.

d. Method.—This method of making a sand table is simple, rapid, and produces all the desired results. One demonstration of this method should be sufficient to permit the non-commissioned officers of a unit to grasp the simple technical requirements and enable them to prepare all sand tables to be used by their organization in the future. Sometimes the said table may be constructed on an inclined plane toward the gun position in order to give instruction more conveniently in the observation and adjustment of fire.

INDEX

	Paragraphs	Pages
Accessories	23	30
Action:		
Rules for placing gun in	33	34
To prepare for	40	39
To put gun into	41	40
To take gun out of	42	42
Action of—		
Counterrecoil	15	16
Firing mechanism	12	15
Recoil	14	16
Safety bolt	13	15
Trigger and sear in firing	11	15
Adjustment for—		
Deflection	105	119
Range	104	115
Adjustment of fire, training in	54	63
Administrative arrangements	132	139
Advice to instructors, purpose	136	142
Aiming point:		
Use of target as	82	84
Using other than target	83	84
Aiming points, direct laying on	66	71
Ammunition	135	141
Authorized rounds	30	33
Care, handling, and preservation	28	32
Classification	25	31
Data	31	33
Identification	27	32
Lot number	26	31
Storage	29	33
Angle of sight of target, determination	88	97
Appointment of examining boards	57	67
Arm and hand signals	101	112
Assembling gun	5	10
Assistant gunner	110	122
Assistant instructors	137	142
Authorized rounds of ammunition	30	33
Bolt, safety, action	13	15
Care and cleaning of gun	7, 142	12, 143
Care of ammunition	28	32
Cartridge case, extraction and ejection	16	17
Characteristics of gun	1	1
Classification of ammunition	25	31
Communication	131	139
Compass:		
Indirect laying by	72	76
Lensatic	19	22
Prismatic	20	26

INDEX

	Paragraphs	Pages
Computation of firing data.....	76	79
Concealment, use of.....	126, 148	137, 146
Constitution of examining boards.....	57	67
Counterrecoil, action.....	15	16
Cover, use.....	126, 148	137, 146
Cradle, filling recoil cylinder of.....	9	14
Crew, to form with equipment.....	35	35
Critique.....	134, 151	140, 147
Data:		
Ammunition.....	31	33
On gun.....	2	2
Date of examination.....	55	66
Defects.....	17	17
Deflection, adjustment for.....	105	119
Demonstration groups.....	138	142
Descriptive of gun.....	3	2
Description of mechanical training.....	140	143
Determination of angle of sight of target.....	88	97
Determination of range.....	89, 124	98, 137
Direct laying:		
Change in fire data.....	65	70
Maximum credits for.....	67	72
On aiming points.....	66	71
On target.....	64	69
Overhead fire with.....	94	108
Sighting triangles.....	63	68
Training in.....	47	49
Training observer in.....	51	57
Direction, to establish.....	86	88
Disassembling gun.....	5	10
Dismounting gun.....	4	5
Drill:		
Gun.....	32-42, 143	34, 144
To change numbers and duties during.....	36	36
Duties of—		
Gun commander.....	97	109
No. 1.....	45	48
No. 2.....	44	47
Observer.....	50	56
Elevation.....	87	95
Laying gun for.....	90	98
Equipment:		
For training.....	112	123
Gun, to examine.....	37	37
To form crew with.....	35	35
To secure to put gun into action.....	34	35
Establishing direction.....	86	88
Examination:		
Place and date.....	55	66
Subjects.....	56	66
Examining boards:		
Appointment and constitution.....	57	67
Certificate of candidates for.....	59	68
Rules governing.....	58	67

INDEX

	Paragraphs	Pages
Execution of fire orders.....	49	56
Exercises:		
Firing.....	133	139
Preparatory.....	123	136
Expert test, maximum credits for.....	78	81
Extraction and ejection of cartridge case.....	16	17
Field firing, individual.....	77	79
Field glass, type EE.....	18	19
Field targets:		
Before unit receives training in firing at.....	121	136
Purpose of firing at.....	120	136
Filling recoil cylinder of cradle.....	9	14
Fire:		
Overhead:		
With direct laying.....	94	106
With indirect laying.....	95	107
Training in adjustment.....	54	63
Types.....	102	113
Fire control.....	53	63
Fire data:		
Direct laying, change in.....	65	70
Indirect laying, change in.....	70	74
Indirect laying with.....	69	73
Fire orders.....	53, 100	63, 110
Execution.....	49	56
Firing:		
Action of trigger and sear in.....	11	15
Long-range.....	117	131
Firing at field targets:		
Before unit receives training.....	121	136
Purpose.....	120	136
Scope.....	122	136
Firing at night.....	115	126
Firing at targets:		
In buildings.....	114	126
In trees.....	113	126
Firing data, computation.....	76	79
Firing exercises.....	133	139
Firing mechanism, action.....	12	15
Firing without sights.....	116	130
Functioning of gun, instruction in.....	141	143
Gun:		
Care and cleaning.....	7, 142	12, 143
Commander, duties and training.....	97	109
Drill:		
Demonstrations.....	143	144
To change numbers and duties during drill.....	36	36
To dismount gun.....	38	38
To examine gun equipment.....	37	37
To form crew with equipment.....	35	35
To form squad column.....	38, 39	38, 39
To mount gun on wheels.....	39	39
To prepare for action.....	40	39

INDEX

	Paragraphs	Pages
Gun—Continued.		
Drill—Continued.		
To put gun into action.....	41	40
To secure equipment to put gun into ac- tion.....	34	35
To take gun out of action.....	42	42
Equipment, to examine.....	37	37
Instruction in functioning.....	141	143
Laying for elevation.....	90	98
Position, selection.....	125, 150	137, 147
Gunner.....	109	122
Assistant.....	110	122
Duties.....	45	48
Position at gun.....	46	48
Training.....	46	48
Hand signals.....	101	112
Handling of ammunition.....	28	32
Identification of ammunition.....	27	32
Indirect laying:		
By compass.....	72	76
Change in fire data.....	70	74
Maximum credits for.....	73	77
Methods of obtaining direction.....	52	62
Overhead fire with.....	95	107
Procedure.....	85	88
To measure minimum range.....	71	75
Training in.....	48	52
Use of telescopic sight in.....	92	102
With first fire data.....	69	73
Individual field firing.....	77	79
Instruction, preliminary.....	149	147
Instructors, assistant.....	137	142
Laying gun for elevation.....	90	98
Lensatic compass.....	19	22
Long-range firing.....	117	131
Lot number of ammunition.....	26	31
Maximum credits for—		
Direct laying.....	67	72
Expert test.....	78	81
Indirect laying.....	73	77
Mechanical training, description.....	140	143
Methods of obtaining direction, indirect laying..	52	62
Minimum range.....	91	99
To measure, indirect laying.....	71	75
Mounting gun.....	4	5
Night firing.....	115	126
Object of gun drill.....	32	34
Observer.....	107	120
Duties.....	50	56
Training, direct laying.....	51	57
Operation of gun.....	6	11
Practices to be avoided.....	10	14

INDEX

	Paragraphs	Pages
Overhead fire:		
General rules for-----	96	108
Table-----	98	109
With direct laying-----	94	106
With indirect laying-----	95	107
Place of examination-----	55	66
Position of gunner at gun-----	46	48
Practices to be avoided in operation of gun-----	10	14
Precautions during unusual conditions-----	8	13
Preliminary instruction:		
Marksmanship-----	149	147
Purpose-----	43	45
Preparation of range cards-----	119	133
Preparatory exercises-----	123	136
Preparatory training-----	111	122
Preservation of ammunition-----	28	32
Prismatic compass-----	20	26
Procedure in indirect laying-----	85	88
Procedure in marksmanship training-----	145	145
Purpose of advice to instructors-----	136	142
Purpose of firing at field targets-----	120	136
Quadrant sight, M1916-----	22	28
Range:		
Adjustment for-----	104	115
Determination-----	89, 124	98, 137
Minimum-----	91	99
Range cards-----	75, 118	77, 132
Preparation-----	119	133
Ranges-----	80	81
Recoil, action in-----	14	16
Recoil cylinder of cradle, to fill-----	9	14
Rules for delivery of overhead fire-----	96	108
Rules for placing gun in action-----	33	34
Rules governing examining boards-----	58	67
Safety bolt, action-----	13	15
Safety measures-----	130	138
Safety precautions-----	80	81
Sand table:		
Place in training-----	152	148
Preparation-----	153	149
Scope of—		
Firing at field targets-----	122	136
Gun drill-----	32	34
Qualification course-----	74	77
Subject No. 1-----	62	68
Subject No. 2-----	68	73
Sear, action of in firing-----	11	15
Selection of gun position-----	125, 150	137, 147
Sensing-----	103	113
Sequence of training-----	147	146
Sight:		
Quadrant, M1916-----	22	28
Telescopic, M1916-----	21	26

INDEX

	Paragraphs	Pages
Sight setter.....	108	121
Sighting triangles, direct laying.....	63	68
Signals, arm and hand.....	101	112
Special precautions.....	8	13
Squad column, to form.....	38, 39	38, 39
Stoppages.....	17	17
Storage of ammunition.....	29	33
Subjects of examination.....	56	66
Table, overhead fire.....	98	109
Target:		
Determination of angle of sight.....	88	97
Direct laying in.....	64	69
Use as aiming point.....	82	84
Targets.....	79, 129	81, 138
Firing at.....	113, 114	126
Telescopic sight, M1916.....	21	26
Use in indirect laying.....	92	102
Terrain.....	128	138
Training:		
Equipment for.....	112	123
In adjustment of fire.....	54	63
In direct laying.....	47	49
In indirect laying.....	48	52
Of gun commander.....	97	109
Of observer in direct laying.....	51	57
Preparatory.....	111	122
Sequence of.....	147	146
Trigger, action of in firing.....	11	15
Types of fire.....	102	113
Units to fire.....	127	138
Use of cover and concealment.....	126, 148	137, 146
Use of telescopic sight in indirect laying.....	92	102

