

MHI
Copy 3

FM 20-15

WAR DEPARTMENT FIELD MANUAL

TENTS AND TENT PITCHING

WAR DEPARTMENT • FEBRUARY 1945

FIELD MANUAL
TENTS AND TENT PITCHING

CHANGE }
No. 1 }

DEPARTMENT OF THE ARMY
WASHINGTON 25, D. C., 23 December 1947

FM 20-15, 24 February 1945, is changed as follows:

3. TENT, SHELTER (NEW TYPE)

* * * * *

b. PITCHING. (Superseded) The tent, shelter, new type is pitched in the same manner as the tent, shelter (old type (par. 2b)), with the exception that after the front corner pins of the tent have been driven, the even-numbered man pins down the front of the tent and then drives the front guy pin so that it is two and one-half tent-pin lengths from the front pin of the triangle.

* * * * *

[AG 900.7 (12 Nov 47)]

BY ORDER OF THE SECRETARY OF THE ARMY:

OFFICIAL: DWIGHT D. EISENHOWER
EDWARD F. WITSELL *Chief of Staff, United States Army*
Major General
The Adjutant General

DISTRIBUTION:

USAF (5); AGF (5); OS Maj Comds (2); Base Comd (2); MDW (10); USAF Maj Comd (5); HD (2); Arm & Sv Bd (1); Tech Sv (2); AMA (2); FC (1); BU (1); Gen & Sp Sv Sch (25); USMA (2); ROTC (1); Tng Ctr (5); A (ZI) (25), (Oversea) (10); CHQ (10); D (2); B (1); P (1); Bn (1); C (1); AF (2); W (1); G (1); S (1).

For explanation of distribution formula, see TM 38-405.

WAR DEPARTMENT FIELD MANUAL

FM 20-15

TENTS AND
TENT PITCHING



WAR DEPARTMENT • FEBRUARY 1945

United States Government Printing Office

Washington : 1945



WAR DEPARTMENT
WASHINGTON 25, D. C., 24 February 1945

FM 20-15, Tents and Tent Pitching, is published for the information and guidance of all concerned.

[AG 300.7 (5 Aug 44)]

BY ORDER OF THE SECRETARY OF WAR:

OFFICIAL:

J. A. ULIO
Major General
The Adjutant General

G. C. MARSHALL
Chief of Staff

DISTRIBUTION:

AAF (10); AGF (10); ASF (2); T of Opns (2); Arm & Sv Bd (2); Def Comd (2); Tech Sv (2); SvC (10); HD (2); PC&S (1); Gen & Sp Sv Sch (50); USMA (2); ROTC (1); A (10); CHQ (10); D (2); B (1); R (1); Bn (1); C (1); AF (2); W (1); G (1); S (1).

For explanation of symbols, see FM 21-6.

FOREWORD

This manual contains information and instruction in the care and handling of all tents being issued to the Army. It is an aid for training personnel in the use of tents as well as a handy reference and guide in the field.

Thorough instruction in the care and handling of appropriate tentage should be part of all unit training. One of the first jobs of any commanding officer is to learn the types of tents his unit will use and then to see that the personnel under his command are trained to use them.

Complete information as to the tents issued to any unit may be found in—

1. Table of Equipment 21—information on the issue of individual tentage.
2. Table of Organization and Equipment—number and type of tents issued to particular units. (If the unit has no Table of Organization and Equipment, this information can be found in the appropriate Table of Basic Allowances.)
3. Table of Allowances 20—issue of tentage to posts, camps and stations.
4. AR 30-3000, "Price List of Clothing and Equipage" (correct nomenclature, stock number, unit and price).

CONTENTS

	<i>Paragraphs</i>	<i>Pages</i>
CHAPTER 1. INDIVIDUAL TENTS.		
<i>Section I.</i> Tent, shelter -----	1-3	1
II. Tent, mountain, two-man, complete with pins and poles	4-7	6
III. Hammock, jungle, complete -----	8-11	9
CHAPTER 2. WALL TENTS.		
<i>Section I.</i> Tent, fire-resistant, wall, small, o-d -----	12-13	15
II. Tent, fire-resistant, wall, large, o-d -----	14-15	15
III. Tent, fire-resistant, storage, o-d -----	16-17	18
IV. Pitching and striking wall tents -----	18-20	19
CHAPTER 3. GENERAL-PURPOSE TENTS.		22
<i>Section I.</i> Tent, fire-resistant, squad, M-1942, o-d, 6-foot 2-inch door	21-25	22
II. Tent, fire-resistant, pyramidal, M-1934, o-d -----	26-30	26
III. Tent, fire-resistant, command post, M-1942, o-d -----	31-35	29
IV. Tent, fire-resistant, hospital ward, o-d, 6-foot 2-inch door	36-40	33
V. Tent, fire-resistant, assembly, o-d, tent only -----	41-45	37
VI. Tent, fire-resistant, maintenance, shelter -----	46-50	42
VII. Tent, fire-resistant, surgical truck, o-d -----	51-55	45
VIII. Screen, latrine, fire-resistant, o-d -----	56-60	48
CHAPTER 4. TENT SITE -----	61-63	51
CHAPTER 5. CARE OF TENTAGE -----	64-69	54
CHAPTER 6. HEATING TENT -----	70-74	60
CHAPTER 7. LINES, TENT -----	75-77	62
CHAPTER 8. PINS, TENT -----	78-79	64
CHAPTER 9. POLES, TENT -----	80	66
CHAPTER 10. MISCELLANEOUS INFORMATION -----	81-85	67
APPENDIX. GLOSSARY -----		69

CHAPTER 1

INDIVIDUAL TENTS

Section I. TENT, SHELTER

1. PURPOSE. When individual tents, shelter half, are authorized, the normal basis of issue per individual is one tent, shelter half, with the required number of pins and poles. Thus, two individuals carry and occupy one complete tent, shelter. There are two types of shelter half: the tent, shelter half (old type) and the tent, shelter half, new type. The tent, shelter half, new type is issued when available, but the old type will be issued until the supply is exhausted. The only difference between the two types is that the new type has a triangular piece at both ends which makes it possible to close the tent completely. This new type is superior, particularly for use in cold climates and for protection against wind and rain. In addition to its use as sleeping quarters,

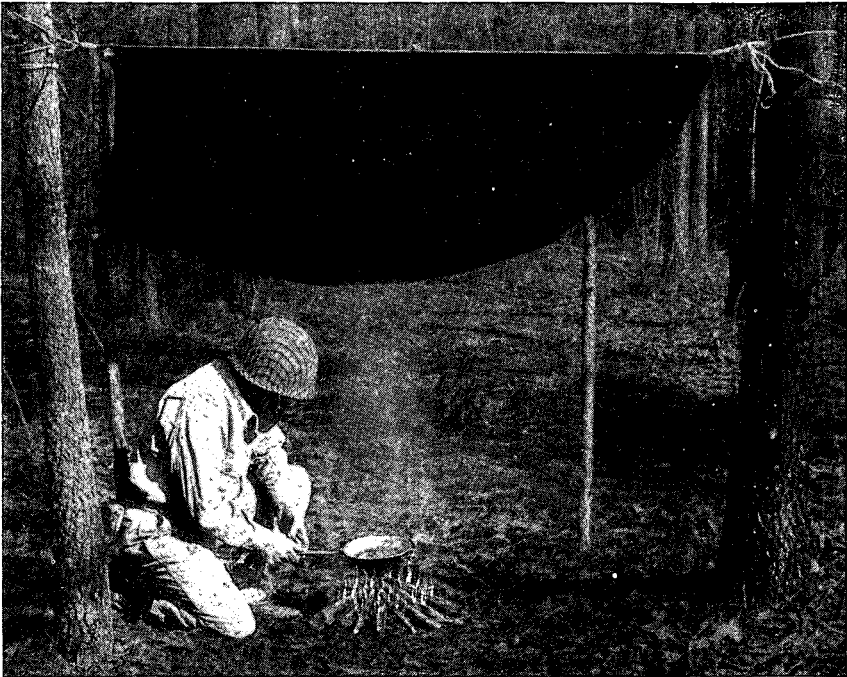
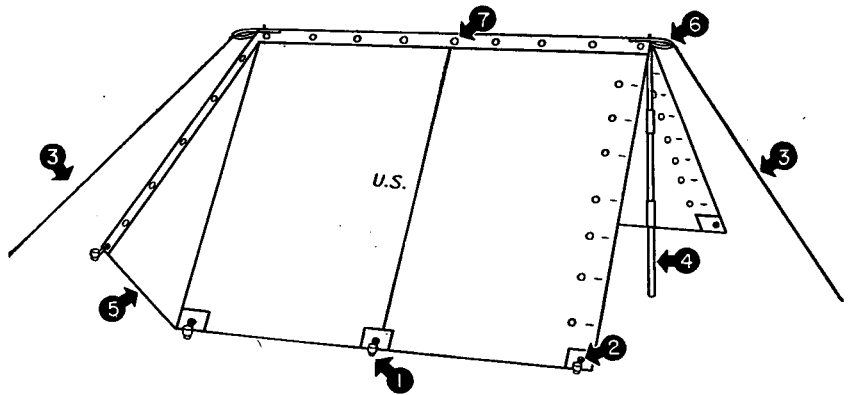

Figure 1. Shelter half used as fly.

the shelter half may also be used as a fly to protect a man while cooking. (See fig. 1.) A shelter half with the necessary number of pins and poles is an individual item of issue. It becomes the responsibility of the individual to whom it is issued and it will usually be carried as part of the field pack.



Parts	Quantity	Stock No.
1. Pins, tent, shelter, wood	10	74-P-125
2. Lines, foot stop, tent, shelter half	8	74-L-67
3. Lines, guy, tent, shelter half	2	74-L-70
4. Pole, tent, shelter	2	74-P-225
5. Triangular end piece.		
6. Loop.		
7. Buttons.		

Figure 2. Tent, shelter (old type) (composed of two tents, shelter half (old type), stock No. 74-T-100.)

2. TENT, SHELTER (OLD TYPE). a. Characteristics. (1) The back of the tent is shaped like an inverted V, and the front is open.

(2) This tent is made of 33-inch wide, 7.9 ounce cotton duck material which has been treated with aluminum acetate, wax, and soap to make it highly water repellent. It comes in two sections which button together to make it into a two-man tent.

(3) It has a ridge height of 43 inches.

(4) Added ventilation may be secured by opening the closed end of the tent as desired.

b. Pitching. (1) *General.* The purpose of instructing men in formal shelter tent pitching is to enable the unit commander to establish his unit effectively and rapidly in shelter tents. Except at formal inspections, the employment of the best available ground for concealment and for the comfort of the men (fig. 3) will have priority over specific alignments and intervals between tents. However, the principles of pitching



Figure 3. Bivouac in the field.

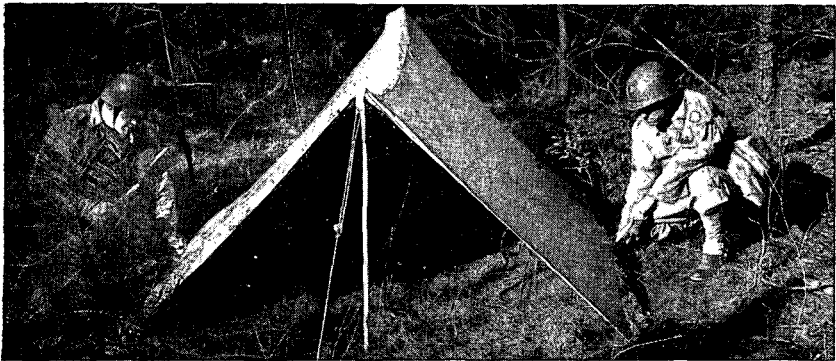
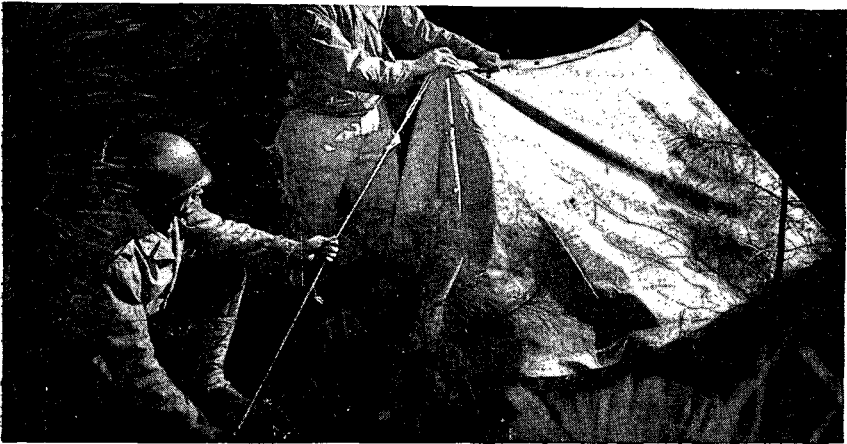

Figure 4. Three steps in pitching shelter tent in the field.

the tent will always be the same. (See fig. 4.) In the field, it takes one man approximately 7 minutes to erect this tent, but it can be done in much less time when two men erect the tent. The officer or noncommissioned officer in charge indicates the area for each platoon (or section) or the line on which its tents are to be pitched.

(2) *Formal shelter tent pitching.* (a) The platoons or sections are formed for formal shelter tent pitching as prescribed in FM 22-5. When directed by the officer in charge, each odd-numbered man marks his position with the outside of his left heel near the instep. The locations marked thus indicate the positions of the front tent poles. Odd and even numbers (numbers 1 and 2, numbers 3 and 4, etc.) pitch tents together.

(b) When the command for pitching tents is given, each man (if armed with a rifle) steps off obliquely with the right foot a full pace to the right front, and lays his rifle on the ground, muzzle to the front, barrel to the left, butt near the toe of his right foot. He then steps back into place. All men then unsling equipment and place their packs (or rolls) on the ground in front of them, haversacks (saddlebags or field canvas packs) up and to the front, the packs two paces in front of the men's positions. Each man then opens his pack and removes his shelter half, poles, and pins. Each odd-numbered man places a pin in the ground on the spot which he previously marked with his left heel. Each man of each pair spreads his shelter half on the ground which the tent is to occupy, buttons to the center, triangle to the rear, the even-numbered man's shelter half being on the left. It will be necessary to see that one of the halves is right side out and that the other is inside out, otherwise both rows of buttons and buttonholes will not match for fastening. The right side of the tent can be determined by the letters "U.S." stamped thereon.

(c) They then button the halves together. The odd-numbered man adjusts his pole through the eyelets in the front of the tent and holds the pole upright in position beside the pin. The even-numbered man pins down the front corner of the tent in line with the pins. He then drives the front guy pin a tent-pole length ahead of the front pole. The even-numbered man places the loop of the guy line over the front



Figure 5. *Formal shelter tent pitching; adjusting the front guy line.*

guy pin, runs the other end of the line through the loops of the shelter halves and ties it, making sure that the pole is vertical when the line is taut. (See fig. 5.) He then adjusts the rear tent pole through the eyelets in the rear of the tent. The odd-numbered man pins down the rear of the tent and drives the rear guy pin so that it is two and one-

half tent-pin lengths from the rear pin of the triangle. He then adjusts the guy line. The even-numbered man then drives the remaining pins on the left of the shelter tent and the odd-numbered man drives them on the right.

(3) *Pitching double shelter tents.* (a) This tent may be pitched singly, or two tents may be pitched together as a double shelter tent. The double-tent camp is preferable to the single-tent camp in cold or



Figure 6. Formal shelter tent pitching; ready for inspection.

inclement weather because of the added shelter it affords. It is useful in restricted areas because of its greater concentration of personnel. The double tent is composed of two old type shelter tents buttoned together at the square ends. The tent is supported by three poles, one in the center and one at each end. Double shelter tents can be used only with the old type shelter tent because the shelter tent, new type has built-in double ends.

(b) On direction of the officer in charge one man marks the position of the front pole with the outside of his left heel, near the instep and places a pin in the ground at this spot. The four men of each group pitching tents together spread their shelter halves on the ground which the tent is to occupy. The men button together the four shelter halves of each tent, the ridge first, and then the square ends so that the center eyelets of the shelter halves will be in the following order starting at the bottom: the lower half of the front tent, the lower half of the rear tent, the upper half of the front tent, and the upper half of the rear tent. Two men insert and support the front and rear poles, respectively, the front pole in the location marked, the rear pole in a line with it. The other two men pin the front and rear corners of the tent. One man enters the tent with the pole and assisted by another man, inserts the pole through the center eyelets of the shelter half.

(c) Two men drive two guy pins at each end of the tent one tent-pole length from the corner pins of the tent and on line with the side pins. Then at each end of the tent they adjust the guy lines through both loops at once and fasten them. They drive the remaining pins.

c. Striking. To strike shelter tents, the men first unbutton sufficient buttons to grasp the tent poles and then let them fall either to the left or to the right. When the tent is flat on the ground they pull the pins, unbutton the shelter halves, and roll their packs.

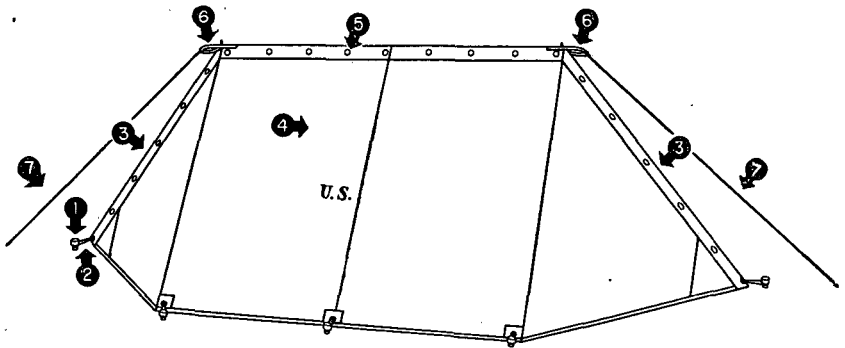

Parts	Quantity	Stock No.
1. Pins, tent, shelter, wood	10	74-P-125
2. Lines, foot stop, tent, shelter half	10	74-L-67
3. Doors.		
4. Tent, shelter half, new type	2	74-T-102
5. Buttons.		
6. Loop.		
7. Lines, guy, tent, shelter half	2	74-L-70

Figure 7. Tent, shelter, new type (composed of two tents, shelter half, new type).

3. TENT, SHELTER (NEW TYPE). a. Characteristics. The characteristics of this tent are the same as those of the tent, shelter (old type) with the following exceptions:

- (1) It has an added V-section on the front end.
- (2) It may be ventilated by opening one end or both ends as desired.

b. Pitching. The tent, shelter, new type is pitched in the same manner as the tent, shelter (old type) (par. 2b) with the following exceptions:

- (1) When spreading the shelter halves preparatory to buttoning them together, both halves should be right side out with buttons to the center and the even-numbered man's shelter half on the left.
- (2) After the front corner pins of the tent have been driven, the even-numbered man pins down the front of the tent. He then drives the front guy pin so that it is two and one-half tent-pin lengths from the front pin of the triangle, or the distance from the base of the front tent pole to one of the front tent pins.

c. Striking. See paragraph 2c.

Section II. TENT, MOUNTAIN, TWO-MAN, COMPLETE WITH PINS AND POLES

4. PURPOSE. The mountain tent is a lightweight, waterproof, two-man tent for use in cold climates. (See fig. 8.) It is reversible and may be pitched with either the olive-drab or white side out, depending on which will provide the better camouflage. The tent, shelter half, will not be issued when the two-man mountain tent is issued.

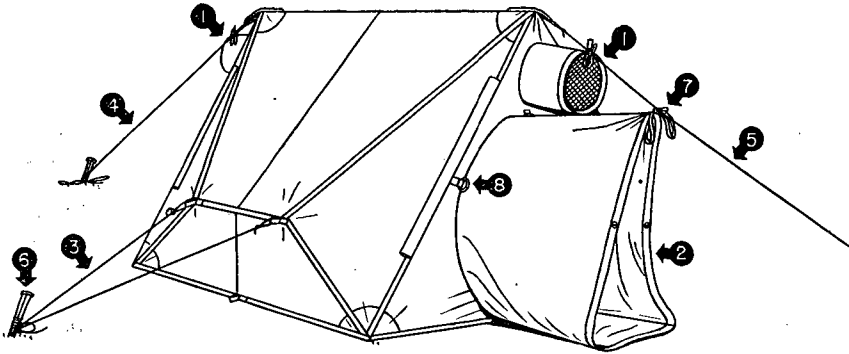

Part	Quantity	Stock No.
1. Ventilators	2	
2. Tunnel (entrance)		
3. Lines, eave, tent, mountain, two-man	4	74-L-66
4. Line, guy, tent, mountain, two-man (rear)	1	74-L-67-50
5. Line, guy, tent, mountain, two-man (front)	1	74-L-67-50
6. Pins, tent, mountain, two-man (metal)	6	74-P-118
7. Tie string.		
8. Tabs.		
Poles, tent, mountain, two-man (each pole consists of one upper section, one middle section, and one lower section)	4	74-P-224-65

Figure 8. Tent, mountain, two-man, complete with pins and poles, stock No. 74-T-90.

5. CHARACTERISTICS. a. The tent made of cotton cloth, with its component parts, weighs 9 pounds 7 ounces. New tents which weigh 8 pounds 11 ounces are being made of nylon. The stock number for both the cotton and nylon tents is the same.

b. This tent is 54½ inches wide, 82 inches long and 43 inches high.

c. The floor space of this tent is 30.7 square feet.

d. This tent has a ridge height of 43 inches and a wall height of 12 inches (formed by stretching guy ropes on each side). This gives the tent a 31-inch pitch.

e. The tent has one tunnel door, tubular in shape, 27 inches in diameter, and 24 inches long. (See fig. 8.) This tunnel entrance may be tied up tight either from the inside or the outside by means of the tie string. (See fig. 8.) Wind tie string around the tunnel entrance as if the entrance were the mouth of a bag and fasten it with a half hitch. The entrance may be kept wide open by tying the tabs on the edge of the tunnel together. (See fig. 9.)

f. The floor is sewed into the tent. Special care should be taken not to tear the floor with nails of boots.

g. Ventilators 8 inches in diameter, covered with mosquito netting, are at each end of the tent. (See fig. 8.) Ventilation is of the greatest importance in the mountain tent because the cloth is absolutely airtight. In good weather the ventilators are kept wide open by hooking them up to the guy ropes; in storms, they are left hanging loosely to provide adequate protection as well as ventilation. Only under exceptional circumstances are the ventilators closed with the tapes. *This should never be done when the cook stove is lighted because of the danger of carbon monoxide.* In cold weather there is an additional reason for leaving them open. Unless the moisture caused by breathing and cooking can pass off into the outside air, it forms as frost inside

on the roof of the tent. In a wind this shakes off and wets the clothes and sleeping bags.

h. Since the interior of the tent is extremely susceptible to dampness, the following individual precautions should be taken:

(1) Each man must take great care to brush all the snow off his clothes and boots before entering the tent. Snow in the tent will melt and wet sleeping bags and clothes.



1. Tunnel entrance rolled back.
2. Ventilator.
3. Tabs.

Figure 9. Tunnel entrance and front ventilator.

(2) One man should enter the tent first and take the sleeping bags, packs, and other articles from the other man after the latter has brushed them off completely.

Note: The new two-man mountain tent has an entrance (like the one described in a above) at each end for better ventilation and greater utility.

6. PITCHING. a. Wind considerations. The tent should be pitched with one of the back corners, rather than a side or the front, facing toward the wind. If the tent is pitched on snow with the entrance directly down wind, the entrance may become blocked, since snow tends to pile up in the lee of any object.

b. General procedure. One man can erect the tent in approximately 10 minutes by following these directions:

- (1) Place the side of the tent having the desired color on the outside.
- (2) Divide the tent pole sections into four groups, each group having a bottom section with a spiked end, a middle section, and a top section with an eye and disk, or a rectangular wire loop.
- (3) Assemble two of the poles in the outside sleeves in the front of the tent. (The sleeves are found inside and outside the tent along the seams which join the sides to the front and to the back.) Slip the spindles on the bottoms of the poles through the loops in the bottom corners of the tent.

(a) If the poles have rectangular wire loops at the top, slip one loop through the other. Twist the pole a half-turn, to lock them together.

(b) If the poles have eyes and disks at the top, place the eyes over each other. Slip the toggle through both eyes and through the grommet at the peak of the tent. Lock the toggle.

(4) Assemble the rear poles similarly.

(5) Attach the guy ropes to the webbing loops on the front and rear peaks of the tent.

(6) Stake out the front and rear guy ropes on tent pins.

(7) Attach side guys to loops on the sides of the tent.

(8) Stake out the side guy ropes on tent pins. Both ropes may be attached to the same pin.

(9) To anchor the corners, tie ropes to the loops at the corners and stake them to the front or back pin.

c. Special procedure. (1) In rocky terrain, it may be impossible to drive the tent pins into the ground. In that case, attach the guy ropes to rocks.

(2) If the snow on which the tent is pitched is loose and powdery, the guy ropes may be attached to ski poles or ice axes, which are driven down into the snow after it has been packed; or they may be attached to a "dead man" anchor. This is made by burying a tent pin or stick horizontally in a hole in the snow and stamping the snow on top of the anchor until it is thoroughly packed.

d. When tent alone is used. It is not always necessary to carry the complete unit. Occasionally in wooded terrain the tent alone is used in order to achieve maximum mobility and to save weight. In such cases, the corners are staked down with any sticks or stones that are available; then the front and rear guy ropes are also staked with available sticks or rocks. If the ridge of the tent sags, it may be supported by the loop which is in the center of the ridge. Skis and ski poles may be used in place of tent poles and pins.

7. STRIKING AND FOLDING. When camp is broken, the mountain tent must be handled carefully if it has frozen in place as a result of successive thawing and freezing. Shovels must be used with the greatest care, since it is easy to rip the tent while digging it out. Ice remaining on the tent should be carefully removed before the tent is packed up.

Section III. HAMMOCK, JUNGLE, COMPLETE

8. PURPOSE. The jungle hammock has been developed for the use of troops operating in jungle areas where conditions are not desirable for bivouac on the ground. (See fig. 10.) It combines the functions of a hammock, insect bar, and a waterproof tent fly. It enables men to sleep off the ground and thus avoid dampness and vermin. The complete jungle hammock weighs only 6 pounds, a minimum weight for sleeping equipment. When authorized, the jungle hammock is issued in place of the tent, shelter half. It can be pitched as an individual tent when the man is forced to sleep in treeless areas. It is insectproof and well-ventilated when used as a one-man tent. (See figs. 12 and 13.) When a man must remain clothed and ready to fight instantly, he can spread his jungle hammock over him as a protection from rain and insects.

9. CHARACTERISTICS. a. The unit is stitched together. It can be slung quickly between trees or other supports.

b. Two 10-foot lengths of rope are issued with each jungle hammock to be tied to the supporting rings.

c. A false bottom is stitched under the hammock proper to prevent insects from biting the sleeper's back. This false bottom also makes a still-air space below the sleeper which acts as an insulator.

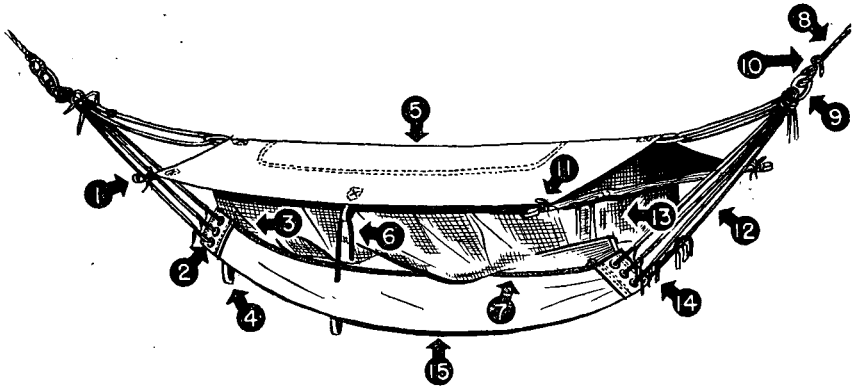

- | | | |
|--------------------|----------------------------|------------------------|
| 1. Spreader stick. | 6. Loops. | 11. Corner tie string. |
| 2. Grommets. | 7. Zipper opening. | 12. Bridle. |
| 3. Foot end. | 8. Hammock rope. | 13. Side wall. |
| 4. Snap straps. | 9. Hammock or bridle ring. | 14. Drip string. |
| 5. Hammock top. | 10. Bowline knot. | 15. False bottom. |

Figure 10. Hammock, jungle, complete, stock No. 74-H-60.

d. Corner tie strings are provided, one at each of the four corners of the hammock top to tie in spreader sticks. The corner tabs are bound close to the stick. The corner strings should not be used to tie the top directly to bushes or vines as damage to the netting and the top will result.

e. The bridle of the jungle hammock has cords of equal length from

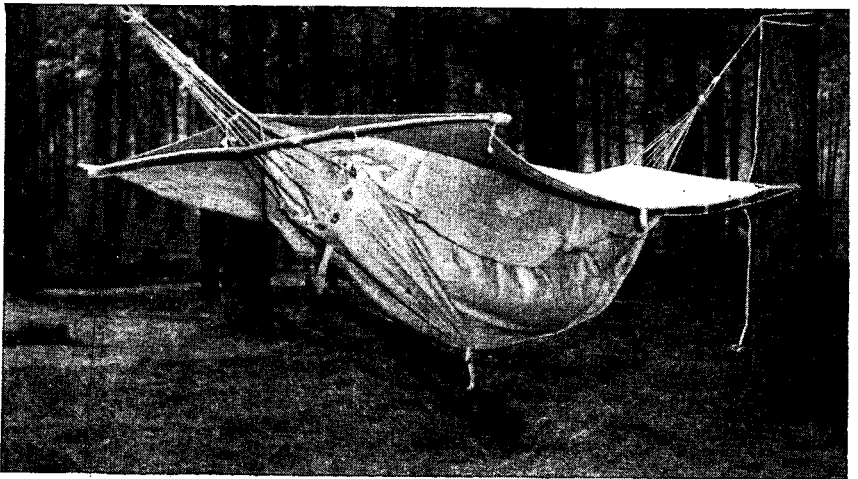

Figure 11. Snap-straps keep equipment off the ground.

the bridle rings to the grommets. Thus the outer edges of the hammock proper are raised sufficiently to keep the sleeper from rolling out.

f. The side walls of the jungle hammock are made of insectproof netting. The foot end is made of corded cloth to prevent the sleeper's feet from being bitten by insects.

g. Two snap straps, stitched under the hammock at the foot end, may be used to keep equipment, especially a rifle, off the ground and out of the rain. (See fig. 11.)

h. The top of the hammock is made of cotton cloth coated with synthetic resin or rubber and given a mildew-resistant treatment.

i. A small pocket inside the hammock is useful to hold medicines and other small articles.

10. RULES TO FOLLOW WHEN USING JUNGLE HAMMOCK. a. Train the troops so that they can sling and unsling the hammocks at night in the jungle or in steep or swampy wooded areas.

b. To obtain the best shelter against stormy weather, sling the hammocks in dense vegetation to break the wind and driving rain.

c. When opening or closing the zipper, be careful to keep the folds of netting and any clothes away from the zipper.

(1) A vertical and a horizontal zipper opening provide the means of getting into and out of the jungle hammock.

(2) A more recent model of the hammock has a single quick-release zipper on one side, between the hammock bed and the netting (fig. 10), which makes it possible to get out of the hammock more quickly. To prevent insects from getting inside the hammock, bunch the extra fullness of netting on the zipper side and tuck it into the loop sewed on the inside edge of the hammock.

d. To get into the hammock, spread out the body of the hammock by hand, and, facing outward, sit with the weight in the center of the hammock, not on the edges. Swing legs toward the solid-fabric foot end and lie down.

e. Keep arms, legs, and face away from the insect netting to avoid being bitten.

f. Tie the elastic cords holding up the hammock top to the bridle ring or bridle cords only. Never tie the top directly to a supporting tree, nor hold it up without elastic support, because this will tear the top and the netting.

g. Cut the string, which is in the small pocket inside the hammock, into short pieces approximately 4 inches long. Tie one of these short strings to each bridle cord, about 3 inches above the grommets. These little tassels of string serve as drip strings and cause the water which runs down the bridle cords to drip to the ground, instead of wetting the hammock.

h. Do not leave hammocks slung in the sunlight when they are not being used, because long exposure to tropical sunlight will damage the top of the hammock.

i. When carrying the jungle hammock, roll or fold it up with the waterproof hammock top and netting *inside*, protected by the false bottom *outside*.

j. *Do not tie the hammock out flat like a bed but hang it loosely with a slight curve.* If it is slung tightly, the zippers and bridles will break and the netting and seams will rip.

11. USES OF HAMMOCK. The jungle hammock may be used in three ways: as a hammock, a tent, or merely as a rainproof covering.

a. Slung as a hammock. (1) Tie the two hammock ropes to two trees that are a convenient distance apart. A satisfactory knot to use is the clove hitch which may be untied in complete darkness with a single jerk.

(2) Tie the hammock rope to the bridle ring by means of a bow-line knot.

(3) Tie two locally cut spreader sticks approximately 4 feet 6 inches in length rather loosely across the ends of the hammock top from the fabric loops at the corners of the top. Pass these sticks completely under the elastic cords supporting the hammock top in order to spread out the top so that rain will not run into the hammock.

(4) Wrap the corner tie strings around both the spreader sticks and corner loops of the hammock top. Always tie the strings with a simple bowknot that can be quickly untied.

(5) If coolness is desired, tie in the spreader sticks above the hammock bridle strings. If warmth or protection from driving rain is required, tie the spreader sticks directly to the hammock bridle strings. This will bring the top of the hammock down close over the sleeping man, producing a smaller and more easily warmed air space above the sleeper's body.

b. Pitched as a tent. For use as an individual, insectproof tent, the jungle hammock may be pitched in several ways. Remember not to tie the top too high or too rigidly. Following are two ways in which the hammock may be pitched as a tent:



Figure 12. Pitched as a tent (first method).

(1) Use the two loops on the sides of the hammock top to lift the top and thus form a ridge line crosswise to the length of the hammock. Insert a stick of appropriate length in each loop to act as supports. The four corners of the hammock top can then be stretched out with cords to form an adequate rainproof covering, or, if more protection

from wind or rain is desired, the four corners may be pinned down to the ground. (See fig. 12.)



OBLIQUE VIEW



FRONT VIEW

Figure 13. Pitched as a tent (second method).

(2) Tie the two corner ropes at the head end of the hammock top to sticks or plants and stretch out the whole hammock top with a downward slope toward the foot end. (See fig. 13.)

c. Spread as a rainproof covering. In case it is impracticable for the individual to sling or pitch his hammock, he can slide the complete hammock over him with the top uppermost to protect his body against rain and insects. Several thicknesses of netting should be used to cover the face. Branches, leaves, or grass should be placed on the ground when circumstances permit, in order to keep the sleeper out of the mud and allow air to reach his body.

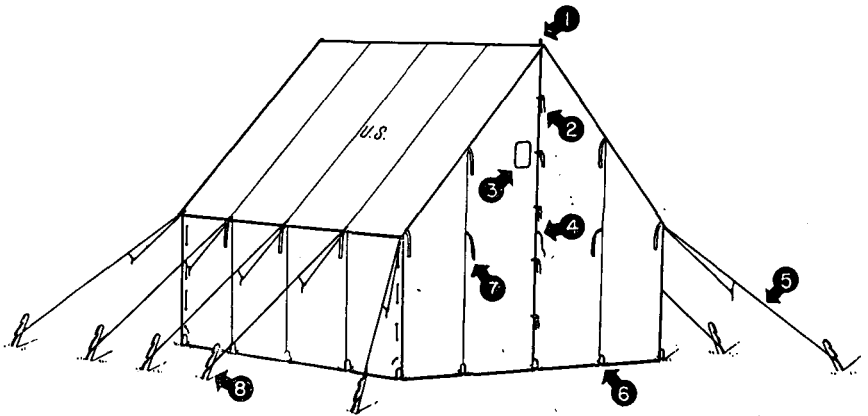

Part	Quantity	Stock No.
1. Spindle.		
2. Lines, tent, 2' 6", sewed-2-end, 1/4" dia. (door fastener) --	18	24-L-470
3. Stovepipe openings.	2	
4. Lines, tent, 2' 6", sewed-2-end, 1/4" dia. (door wall line) _	2	24-L-470
5. Lines, tent, 8', w/eye, 1/4" dia. (eave line) -----	10	24-L-515
6. Lines, tent, foot stop, 1/4" dia. (foot stop) -----	18	24-L-448
7. Wall lines.		
8. Pins, tent, 24" -----	10	24-P-59
Pins, tent, 16" -----	18	24-P-49
Lines, tent, 4' 6", sewed-2-end, 1/4" dia. (lacing line) -----	4	24-L-490
Slips, tent, wire -----	10	24-S-1070
Poles, tent, upright, 9' -----	2	24-P-253
Poles, tent, ridge, 9', wall, small -----	1	24-P-114
Lines, tent, 3' 4", sewed-1-end, 1/4" dia. (door flap line) --	2	24-L-479-50
*Fly, fire-resistant, tent, wall, small, o-d -----	1	24-F-150
Pins, tent, 24" -----	12	24-P-59
Pole, tent, ridge, 9' wall, small -----	1	24-P-114
Poles, tent, upright, 9' -----	2	24-P-253
Lines, tent, 8', w/eye, 1/4" dia. (eave line) -----	10	24-L-515

* For information on the fly, tent, see paragraph 81.

Figure 14. Tent, fire-resistant, wall, small, o-d, stock No. 24-T-323.

CHAPTER 2

WALL TENTS

Section I. TENT, FIRE-RESISTANT, WALL, SMALL, O-D

12. PURPOSE. The normal use of this tent (fig. 14) is for the shelter of officers when in the field and not in combat. It has a capacity of two individuals. When necessary, this tent may also be used as a small storage tent.

13. CHARACTERISTICS. a. This tent is 8 feet 10 inches wide, 9 feet 2 inches long, and 8 feet 6 inches high.

b. The floor space is approximately 80 square feet.

c. It is an A-type, square-end tent, rectangular in shape.

d. The top, side walls, and all reinforcements are made of 12.29-ounce duck and the sod cloth is made of 9.85-ounce duck. This tent comes in one section.

e. This tent has a ridge height of 8 feet 6 inches and a wall height of 3 feet 9 inches. This gives a pitch of 4 feet 9 inches.

f. It has a slit in each end section which overlaps to form doors.

g. One tent stove, M-1941, with accessories is used for heating this tent. There are two stovepipe openings built into this tent, one at each end near the point where the slit forming the door meets the ridge line. This permits the stove to be located at either end of the tent.

h. This tent is ventilated by rolling up the side walls, and also by opening the slits which form doors at each end of the tent. When not in use, the stovepipe openings may be used as ventilators.

Section II. TENT, FIRE-RESISTANT, WALL, LARGE, O-D

14. PURPOSE. Normally this tent (fig. 15) will be used either as an officers' mess or as an office in battalion and higher headquarters when so authorized. It may, however, be used for the storage of supplies or for the quartering of personnel. When used for quartering personnel, its capacity is 8 men without a stove and 6 men with a stove installed. It has a normal capacity, when used for mess purposes, of 20 to 22 men, depending on whether tables 8½ or 10 feet long are used. When equipped with folding camp tables for office purposes, it has a capacity of approximately 12 men.

15. CHARACTERISTICS. a. This tent is 14 feet 6 inches wide, 15 feet 2¼ inches long, and 11 feet high.

b. The floor space is 203 square feet.

c. It is an A-type, square-end tent, which is rectangular in shape. It comes in one section.

d. The top, side walls, and all reinforcements are made of 12.29-ounce duck and the sod cloth is made of 9.85-ounce duck.

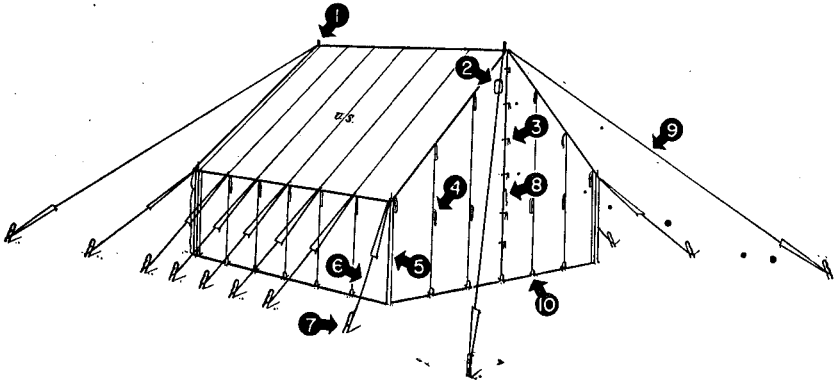

Part	Quantity	Stock No.
1. Spindle.		
2. Stovepipe openings	2	
3. Lines, tent, 2' 6", sewed-2-end, 1/4" dia. (door fastener)	22	24-L-470
4. Wall lines.		
5. Poles, tent, upright, 4' 9"	4	24-P-235
6. Lines, tent, 9', w/eye, 5/16" dia. (eave line)	14	24-L-535
7. Pins, tent, 24"	18	24-P-59
8. Lines, tent, 2' 6", sewed-2-end, 1/4" dia. (door-wall line)	2	24-L-470
9. Lines, tent, 45', sewed-2-end, cut splice in center, 5/16" dia. (guy line)	2	24-L-590
10. Lines, tent, foot stop, 1/4" dia. (foot stop)	26	24-L-448
Poles, tent, upright, 12', complete, jointed	2	24-P-266
Pole, tent, ridge, 14' 2", complete, jointed	1	24-P-150
Pins, tent, 16"	26	24-P-49
Slips, tent, wire	18	24-S-1070
Lines, tent, 3' 4", sewed-1-end 1/4" dia. (extension cloth line)	2	24-L-479-50
(door flap line)	2	
Lines, tent, 6', sewed-2-end, 1/4" dia. (lacing line)	4	24-L-500
Fly, fire-resistant, tent, wall, large o-d	1	24-F-140
Pins, tent, 24"	14	24-P-59
Pole, tent, ridge, 14' 2", complete, jointed	1	24-P-150
Poles, tent, upright, 12' 3", complete, jointed	2	24-P-266
Lines, tent, 10', w/eye, 1/4" dia. (eave line)	14	24-L-539

Figure 15. Tent, fire-resistant, wall, large, o-d, stock No. 24-T-322.

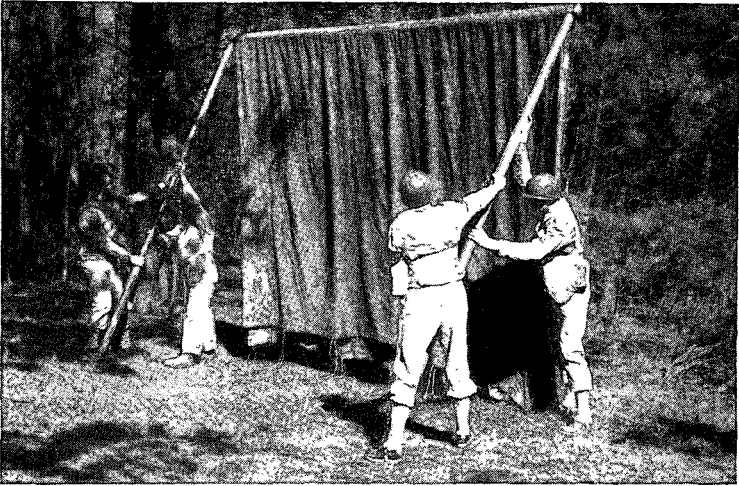
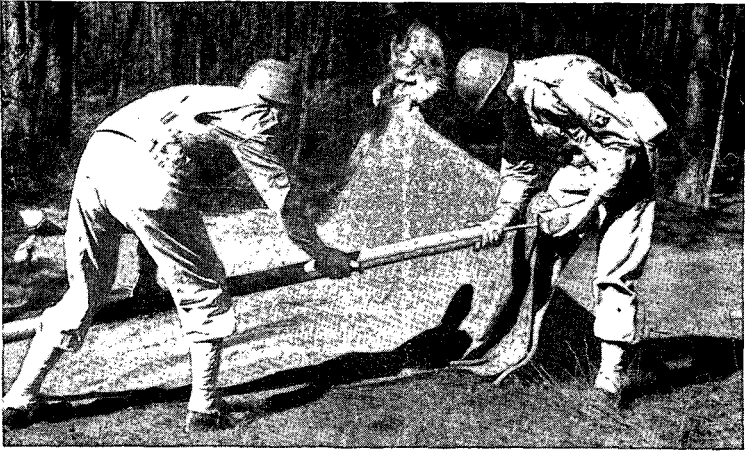

Figure 16. Pitching the tent fly.

e. It has ridge height of 11 feet and a wall height of 4 feet 6 inches, which gives a pitch of 6 feet 6 inches.

f. Doors are formed by slits in the middle of each end section, which are overlapped. These are tied with rope door fasteners.

g. A fly, measuring 21 feet 6 inches by 14 feet 5 inches, is available as a separate item of issue when authorized. (See par. 81.) It is very simple to pitch and strike (fig. 16) and serves adequately as a field kitchen. (See fig. 17.)

It is often erected against the rear of a kitchen truck. The cooking is then done in the truck and the food is served under the fly.

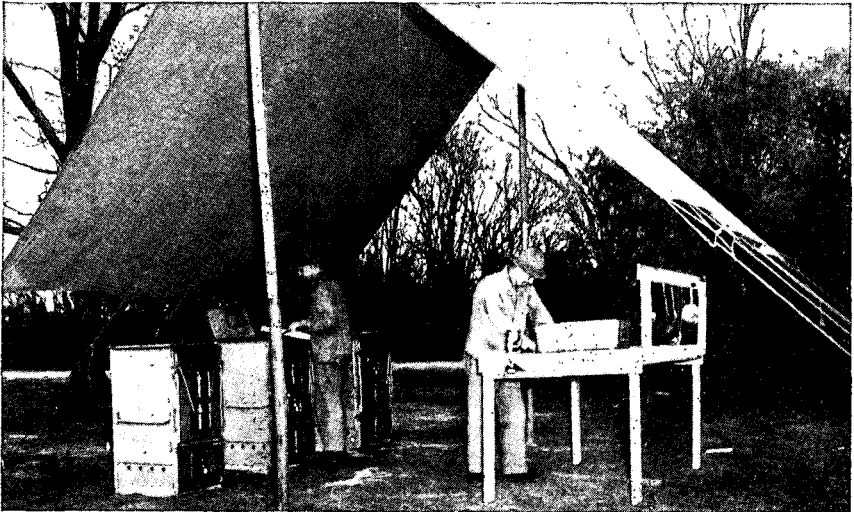

Figure 17. The tent fly is used as a field kitchen.

h. One tent stove, M-1941, with accessories, is used to heat this tent.

i. There are two ventilator openings, also used as stovepipe openings, built into this tent. They are protected by means of canvas flaps.

Section III. TENT, FIRE-RESISTANT, STORAGE, O-D

16. PURPOSE. The normal purpose of this tent (fig. 18) is for the storage of supplies in the field when other shelter is not provided. This tent may be used for the quartering of personnel. When used for this purpose, it has a capacity of 10 individuals. It is a limited standard item of issue and will eventually be replaced by the squad tent.

17. CHARACTERISTICS. a. This tent is 17 feet 10 inches wide, 20 feet 5 inches long, 13 feet high.

b. The floor space is approximately 358 square feet.

c. It is an A-type, square-end tent, rectangular in shape.

d. The top, side walls, and all reinforcements are made of 12.29-ounce duck and the sod cloth is made of 9.85-ounce duck. The whole tent is fabricated in one piece. The walls are split at all four corners for the purpose of lacing. It can be erected with or without a ridge pole.

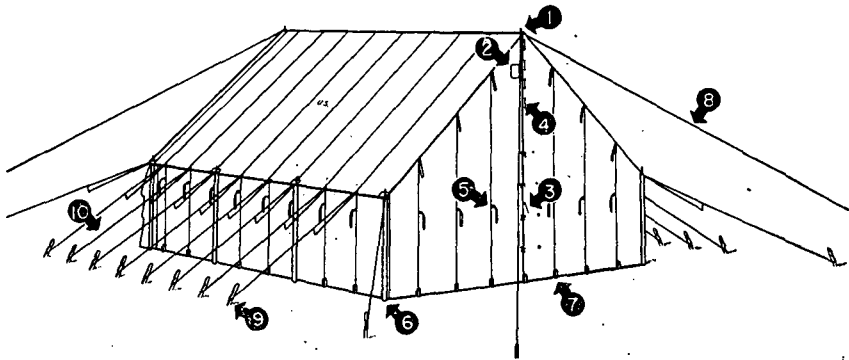

Parts	Quantity	Stock No.
1. Spindle.		
2. Stovepipe openings	2	
3. Lines, tent, 2' 6", sewed-2-end, 1/4" dia. (door fastener or door wall line)	18	24-L-470
4. Lines, tent, 6', sewed-2-end, 1/4" dia. (lacing line)	6	24-L-500
5. Wall lines.		
6. Poles, tent, upright, 5' 5"	8	24-P-240
7. Lines, tent, foot stop, 1/4" dia. (foot stop)	36	24-L-448
8. Lines, tent, 48', sewed-2-end, cut splice in center, 5/16" dia. (guy line)	2	24-L-605
9. Pins, tent, 24"	24	24-P-59
10. Lines, tent, 10', w/eye, 5/16" dia. (cave line)	20	24-L-540
Poles, tent, upright, 13' complete, jointed	3	24-P-273
Pole, tent, ridge, 20' 3 1/2", jointed	1	24-P-220
Pins, tent, 16"	36	24-P-49
Slips, tent, wire	42	24-S-1070
Lines, tent, 3' 4", sewed-1-end, 1/4" dia. (door flap line)	2	24-L-479-50
(extension cloth line)	2	
*Fly, fire-resistant, tent, storage, o-d	1	24-F-130
Pins, tent, 24"	20	24-P-59
Pole, tent, ridge, 20' 3 1/2", complete, jointed	1	24-P-220
Poles, tent, upright, 13', complete, jointed	3	24-P-273
Lines, tent, 11' 6", w/eye, 1/4" dia. (cave line)	20	24-L-550-25

* For information on the fly, tent, see paragraph 81.

Figure 18. Tent, fire-resistant, storage, o-d, stock No. 24-T-321.

e. It has a ridge height of 13 feet and a wall height of 5 feet 2 inches, which gives a pitch of 7 feet 10 inches.

f. This tent has two doors which are formed by a split in the center of each end section or wall.

g. One tent stove, M-1941, with accessories, is used to heat this tent. There are two stovepipe openings, one built into each end of the storage tent. When they are not in use for this purpose, they may be employed as ventilators.

h. When the stovepipe openings cannot be used to provide ventilation because the stove is installed, or do not provide sufficient ventilation, this tent is ventilated by rolling up the side walls and opening the ends.

Section IV. PITCHING AND STRIKING WALL TENTS

18. PITCHING. a. **Preliminary arrangements.** The officer or noncommissioned officer in charge selects suitable ground. He indicates the direction in which the tent is to face, the line on which the tent is to be

placed, and the position of the door pin. It requires approximately 20 minutes for four men to pitch the large and small wall tents, and 30 minutes for eight men to erect the storage tent.

b. Procedure for each tent. (1) Drive a pin to mark the center of the door.

(2) Spread the tent on the ground it is to occupy, placing the door foot stops over the door pin.

(3) Draw the front corners taut, align, and pin down.

(4) Lace the rear door, if there is one.

(5) Draw the rear corners taut in both directions and pin down.

(6) Drive the four eave line pins on each corner in prolongation of the diagonals of the tent and about two paces beyond the corner pins.

(7) Loosen the front door.

(8) Loosen the two corner foot stops from the corner pins on one side only.

(9) Insert the ridge pole between the ventilation strip and the tent ridge.

(10) Insert the spindle of the upright poles in the ridge pole and in the grommets of the tent.

(11) Raise the tent and hold it in position. (See fig. 19.)



Figure 19. Pitching the tent, wall, small.

(12) Replace the two loosened corner foot stops and secure and tighten the guy lines to hold the poles vertical.

(13) Drive the wall pins through the foot stops as they hang, and finally, drive intermediate eave-line pins in alignment with the eave-line pins already driven.

19. STRIKING. **a.** Remove all pins, except those of the four eave lines on the corners and the corner wall pins on the down-wind side, and place them in a receptacle.

b. Have the men unfasten the guy lines and hold them while the tent is being lowered.

- c. Lower the tent down wind.
- d. Remove the poles and remaining corner wall pins. Fasten the poles together and collect the remaining pins.

20. FOLDING. a. Spread the tent flat on the ground, folded at the ridge so that the bottoms of the side walls are even, the sod cloth folded under, and the ends of the tent forming triangles to the right and left.

- b. Fold in the bottom of the wall approximately one foot.
- c. Fold the triangular ends of the tent in toward the middle to form a rectangle.
- d. Fold the top over about 9 inches.
- e. Fold the tent again by carrying the top fold over to the foot, and again from the top to the foot.
- f. Throw all the eave and guy lines onto the tent except the second eave line from each end.
- g. Fold the ends in so as to cover about two-thirds of the width of the second panel.
- h. Double the left fold over the number of times required to bring the resulting bundle into position 3 to 5 inches from the right fold.
- i. Place the right fold in position on top completing the bundle.
- j. Tie the bundle with the two exposed eave lines.

CHAPTER 3

GENERAL-PURPOSE TENTS

Section I. TENT, FIRE-RESISTANT, SQUAD, M-1942, O-D, 6-FOOT 2-INCH DOOR

21. PURPOSE. This tent (fig. 20) is used principally for the quartering of men. It will shelter 16 men when stoves are not installed, or 12 men when stoves are installed. It may also be used as a small field hospital, or field bakery, for storage, or for any other general purpose. This tent is gradually taking the place of pyramidal and storage tents, which have become limited standard items and will be issued only until the stock is depleted. This present model of the tent is a revision of the old type squad tent, M-1942. For all practical operations, such as pitching and

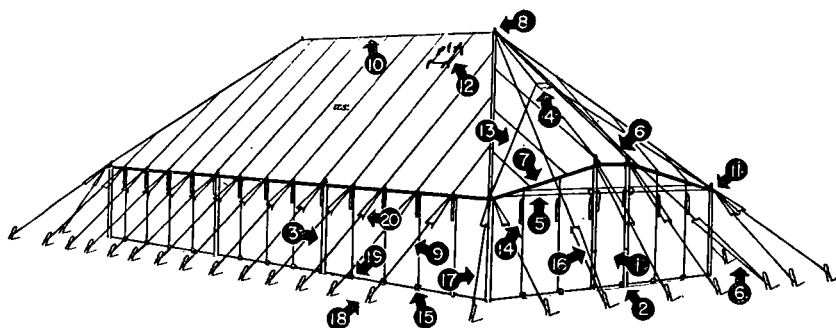

Part	Quantity	Stock No.
1. Entrance -----	2	
2. Poles, tent, upright, 6' 2" -----	4	24-P-242-75
3. Poles, tent, upright, 4' 9" -----	8	24-P-235
4. Ventilator -----	2	
5. Reinforcing band.		
6. Lines, tent, 50', sewed-2-end, cut splice in center 5/16" dia. (guy line) -----	2	24-L-610
7. All-round eave roping.		
8. Spindle.		
9. Lines, tent, 10', w/eye, 5/16" dia. (eave line) -----	26	24-L-540
10. Pole, tent, ridge, 17' complete, jointed -----	1	24-P-157
11. D-ring.		
12. Stovepipe outlet -----	2	
13. Lines, tent, 13' 6", sewed-1-end, 1/4" dia. (ventilator flap line) -----	4	24-L-562-50
14. Wall lines.		
15. Lines, tent, foot stop, 1/4" dia. (foot stop) -----	42	24-L-448
16. Lines, tent, 3' 4", sewed-1-end, 1/4" (door flap line) -----	4	24-L-479-50
17. Lines, tent, 14', w/eye, 5/16" dia. (corner line) -----	12	24-L-565
18. Pins, tent, 24" -----	42	24-P-59
19. Pins, tent, 16" -----	42	24-P-49
20. Slips, tent, wire -----	50	24-S-1070
Lines, tent, 6', sewed-2-end, 1/4" dia. (lacing line) -----	4	24-L-500
Lines, tent, 2' 6", sewed-2-end, 1/4" dia. (door fastener) --	20	24-L-470
Poles, tent, upright, 12' 3", complete, jointed -----	2	24-P-266

Figure 20. Tent, fire-resistant, squad, M-1942, o-d, 6-foot 2-inch door.

striking, the two tents are the same. The new tent has several improvements, such as the two vertical doors, new ventilators, separate stovepipe outlets, and other minor features.

22. CHARACTERISTICS. **a.** This tent is 16 feet wide, 32 feet 9 inches long, and 12 feet high.

b. The floor space of this tent is 512 square feet.

c. It is a hip-roofed, square-end tent, rectangular in shape.

d. The top, side walls, and all reinforcements are made of 12.29-ounce duck, and the sod cloth is made of 9.85-ounce duck. The whole tent is fabricated in one piece. The walls are split at all four corners for lacing. It can be erected with or without a ridge pole.

e. It has a ridge height of 12 feet and a wall height of 4 feet 6 inches, which gives a pitch of 7 feet 6 inches.

f. It has two doors (one at each end of the tent) which are 6 feet high and 2 feet 6 inches wide.

g. This tent is ventilated by two openings, one at the top of each end section near the ridge line. These openings are protected by means of canvas flaps.

h. There are two stovepipe openings built in the top near the two large upright poles of this tent. These stovepipe openings are protected by means of canvas flaps. When the stoves are not being used, these openings may be employed as ventilators.

i. Two tent stoves, M-1941, with accessories, are used to heat this tent.

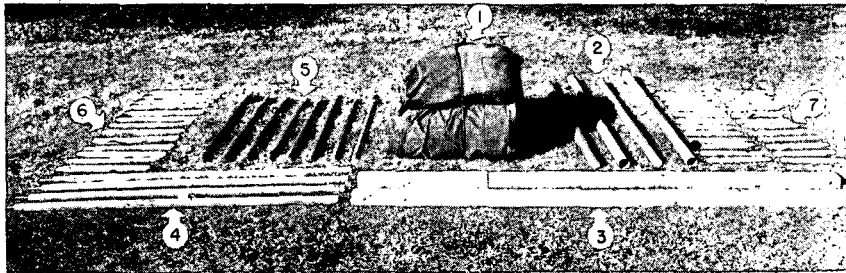

	Parts	Quantity
1.	Tentage (lines and canvas)_____	2
2.	Poles, tent, upright, 12' 3", complete, jointed_____	1
3.	Pole, tent, ridge, 17', complete, jointed_____	4
4.	Poles, tent, upright, 6' 2"_____	8
5.	Poles, tent, upright, 4' 9"_____	42
6.	Pins, tent, 24"_____	42
7.	Pins, tent, 16"_____	42

Note. For stock numbers, see figure 20.

Figure 21. Component parts of tent, fire-resistant, squad, M-1942, o-d, 6-foot 2-inch door.

23. PITCHING. **a. General.** The officer or noncommissioned officer in charge designates the line upon which the tent is to be pitched. A short pin (No. 1) is then driven into the ground to mark the location (as the tent faces the company street) of the right front corner wall of each tent. The pins are placed at intervals of 30 feet. This allows a space of about 2 feet between tents. Each squad usually pitches the tent which it is to

occupy. Eight men can erect this tent in approximately 45 minutes. (See fig. 22 for the placing of the tent pins.)

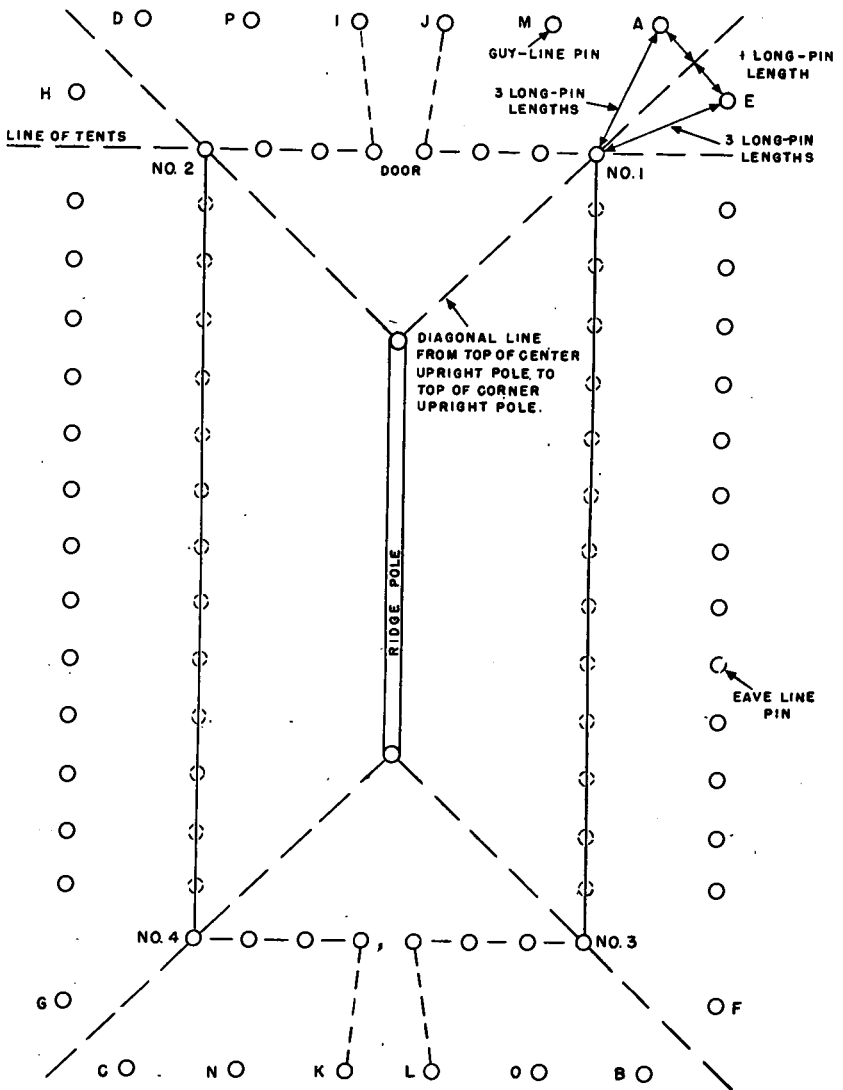

Figure 22. Method of placing pins to pitch tents.

b. Procedure. (1) *Spread canvas.* Unfold and spread the tent on the ground in the approximate position it is to occupy. See that corners are laced together and the doors tied.

(2) Place the right front corner foot stop over the pin.

(3) *Insert short corner tent pins.* (a) Insert a short tent pin (No. 2) in the left front corner foot stop. Leaving a small amount of slack in the left front wall, place this pin on the line established by the right front corner wall pins and drive it into the ground.

(b) Insert a short tent pin (No. 3) in the right rear corner foot stop. Leaving a small amount of slack in the lower right wall, place the pin so that the right side of the tent is perpendicular to the line of front corner wall pins, and then drive the pin into the ground.

(c) Insert a short tent pin (No. 4) in the left rear corner foot stop. Then place the pin so that the left and rear sides of the tent are perpendicular, respectively, to the front and right sides of the tent and drive it into the ground.

(4) *Drive corner-line pins.* Drive into the ground eight temporary corner-line pins, A, B, C, D, E, F, G, and H (as shown in fig. 22), two for each corner. Drive these pins three long-pin lengths from pins, Nos. 1, 2, 3, and 4. Leave about two long-pin lengths between A and E, B and F, C and G, and D and H (after the tent has been erected these temporary corner-line pins must be shifted so that each of the two (for each corner) shall be three long-pin lengths from the corner tent pins, 1, 2, 3 and 4 respectively, and one long-pin length on either side of the prolongation of the line extending from the end of the center upright pole to the top of the corner upright tent pole). Drive I, J, K, and L, the corner-line door pins, on line with A and D and B and C, respectively.

(5) *Drive guy-line pins.* Drive pins M, N, O, and P an equal distance from and on line with J and A, C and K, L and B, and D and I, respectively.

(6) *Insert ridge pole.* Join together the two sections of the ridge pole and insert the pole through one of the ventilating openings of the tent with the rounded edge of the ridge pole next to the ridge of the tent.

(7) *Insert upright poles in ridge pole.* With the spindle foremost, push the two upright poles under the right (left) edge of the tent. Have two men crawl under the tent, one at each upright pole, and insert the spindle of the upright pole through the hole in the ring of the chain and plate assembly. Place the loop of each guy line over the spindle of each upright pole.

(8) *Raise tent.* Designate six men, one for each end of the two guy lines, and one at the ground end of each upright pole, to assist the two men under the tent in raising and steadying it. When all is ready, have the two men under the tent, assisted by the men at the ground end of the upright poles, raise the upright poles at the ridge end, and each man holding a guy line assist by pulling on his line. When the four men have placed the upright poles in a vertical position, have the four men on the guy lines place them over their respective pins, and tighten the lines equally, so as to hold the tent in its upright position. Then, have the corner lines placed over their pins.

(9) *Drive remaining short pins.* Insert the remaining short tent pins in their foot stops at the bottom of the wall, and drive them into the ground on the lines established by the four corner wall pins.

(10) *Drive remaining long pins.* Drive the remaining long pins into the ground opposite each eave line. Place the loop of each tent line in the lower notch of the pin.

(11) *Place side-wall upright poles.* Place the eight side-wall upright poles, two at each door and one at each corner, in a vertical position with the spindle inserted through the grommet.

(12) *Shift temporary corner pins.* Shift the temporary corner pins as explained in (4) above. Then equally tighten all tent lines.

(13) *Final adjustments.* Adjust the ventilators and stovepipe openings and tie their lines to the appropriate tent lines.

24. STRIKING. a. Close all openings. Lace the four corner wall openings. Close the doors and tie together all door fasteners.

b. Remove pins and side wall upright poles. Remove all pins except the left front and left rear corner wall pins and the corner and guy-line pins, and pile them in front of the tent. Remove the eight side-wall upright poles and pile them at the front of the tent.

c. Lower tent. With a man at each upright pole and at the guy and corner lines on the right side, lower the tent gently to the left.

d. Remove remainder of pins and poles. Remove the two upright poles, the ridge pole, and the guy and corner-line pins and pile them in front of the tent.

25. FOLDING. a. Arrange canvas for folding. Grasp the tent at the ridge, pull it to the left until the under side is smooth. Grasp the top (right) front corner foot stop and pull it toward the rear of the tent until the front side of the tent is smooth; then return the corner to a position over the lower (left) front corner foot stop. Do the same with the corner of the top (right) rear wall. Make sure the sod cloth is folded under. All wrinkles should then be removed from the tent.

b. Arrange lines on tent. Neatly coil the two guy lines and place them on the tent along the ridge so that the distance between the two coils is the same as their distance from the ends of the ridge. Lay all exposed eave lines on the tent, except the two center eave lines on the under side.

c. Fold tent lengthwise. Fold in the bottom of the wall approximately 1 foot. Beginning at the ridge, make a fold one and one-fourth long-pin lengths wide and continue folding until the edge of the last fold is even with the bottom edge of the wall.

d. Complete folding. Beginning at the front end of the tent, make a fold to the second panel and continue folding toward the center of the tent, the edge of the last fold extending about one-fourth panel's width beyond the nearest center panel. Do the same with the rear end of the tent, and then place all of the folded rear end on top of the folded front end.

e. Tie bundle. Pull the two tent lines which were left outside toward each other, cross them at right angles, and wrap them around the sides of the folded tent. Cross the lines again at right angles on the bottom side and pull them up over the ends of the tent. Insert the end of one line through the loop of the other, pull it tight, and then tie it with a slipknot.

Section II. TENT, FIRE-RESISTANT, PYRAMIDAL, M-1934, O-D

26. PURPOSE. The main purpose of this tent (fig. 23) is for the quartering of personnel. The maximum capacity of the tent is eight men when the tent stove is not used. However, for reasons of greater comfort and sanitation, it is limited to six men when the supply of tentage permits. When the tent stove is used, the maximum capacity is six men. Because of its distinctive shape, it is easily observed from the air; for this reason more than usual care should be taken to camouflage it properly. This tent is a limited standard item of issue and will eventually be replaced by the squad tent, M-1942.

27. CHARACTERISTICS. a. This tent is 16 feet wide, 16 feet long, and 11 feet high.

b. The floor space is 256 square feet.

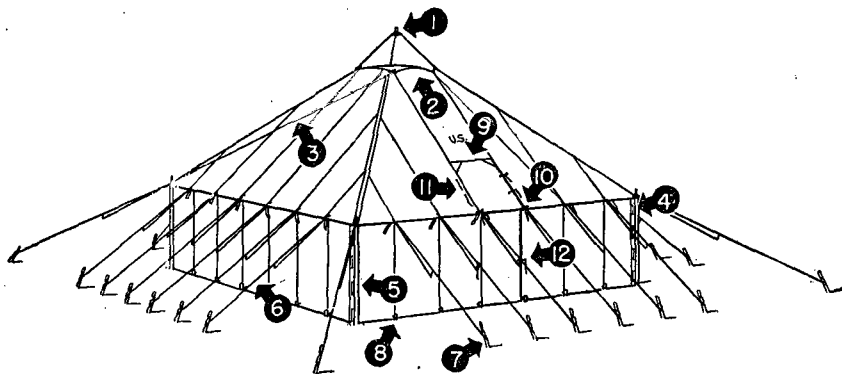

Part	Quantity	Stock No.
1. Spindle.		
2. Hood, tent, khaki, pyramidal, M-1934	1	24-H-115
3. Lines, tent, 13' 6", sewed-1-end, 1/4" dia. (hood line)	6	24-L-562-50
4. Lines, tent, 6', sewed-2-end, 1/4" dia. (lacing line)	4	24-L-500
5. Poles, tent, upright, 4' 9"	4	24-P-235
6. Lines, tent, 10', w/eye, 5/16" dia. (eave line)	24	24-L-540
7. Pins, tent, 24"	28	24-P-59
8. Lines, tent, foot stop, 1/4" dia. (foot stop)	28	24-L-448
9. Door flap.		
10. Lug.		
11. Lines, tent, 2' 6", sewed-2-end, 1/4" dia. (door fastener)	6	24-L-470
Lines, tent, 3' 4", sewed-1-end, 1/4" dia. (door fastener)	10	24-L-480
12. Lines, tent, 3' 4", sewed-1-end, 1/4" dia. (door flap line)	2	24-L-479-50
Lines, tent, 14', w/eye, 5/16" dia. (corner line)	4	24-L-565
Pole, tent, upright, 12' 3", complete, jointed	1	24-P-266
Pins, tent, 16"	28	24-P-49
Chain and plate, tent, pyramidal, M-1934, 16 1/2' x 17'	1	24-C-573
Hooks, tent, end, pyramidal, M-1934, 5/16"	4	24-H-167
Hooks, tent, S, pyramidal, M-1934, 5/16"	4	24-H-174
Slips, tent, wire	28	24-S-1070

Figure 23. Tent, fire-resistant, pyramidal, M-1934, o-d, stock No. 24-T-320.

c. The top, side walls, and all reinforcements are made of 12.29-ounce duck and the sod cloth is made of 9.85-ounce duck. This tent comes in one section.

d. It has a peak height of 12 feet 3 inches and a wall height of 4 feet 2 inches. This gives a pitch of 8 feet 1 inch.

e. It has one door in the wall which is cut back into the roof. This door is 28 inches wide, 8 feet high, and is double-lapped.

f. It is ventilated by a center pole opening which has an adjustable hood or cover. The sides of the tent may be rolled up and the door opened when added ventilation is needed.

g. One tent stove, M-1941, with accessories, is used to heat this tent. When stoves are used in the pyramidal tent, the stovepipe is put through the center opening.

28. PITCHING. a. **Preliminary arrangements.** The commander designates the line on which the tents are to be erected. The line of tents is marked by driving a wall pin on the spot to be occupied by the right front corner of each tent. The interval between adjacent marking pins should be 30 feet. This leaves a space of about 2 feet between tents. Each tent is usually erected by the squad which will occupy it. It takes four men approximately 30 minutes to erect this tent.

b. Procedure. (1) *Spread canvas.* Spread the tent on the ground which it is to occupy, door to the front. Lace the corners of the tent wall, tie the door fasteners, and place the right front corner foot stop over the corner pin already driven.

(2) *Drive left front corner wall pin.* Carry the left front corner foot stop as far to the left as it will go and drive a short pin through it in line with the right corner pin already driven.

(3) *Drive rear corner wall pins.* Pull the rear corner foot stops to the rear and outward, so that the bottom of the rear wall of the tent will stretch to complete the square. Then drive the pins through these foot stops with each rear corner pin directly to the rear of its corresponding front corner pin, forming the square. Unless the canvas is wet, allow a small amount of slack before driving the corner pins.

(4) *Adjust center pole and hood.* Have three men crawl under the tent and fit the center pole into the plate of the chain and plate assembly. Adjust the hood.

(5) *Raise tent.* With a man steadying each corner line, have the men underneath the tent, raise the tent.

(6) *Adjust corner lines.* Place the four corner lines over the lower notches of the large pins, which are driven in prolongation of the diagonals at such distances as to hold the walls and ends of the tent vertical and smooth when the eave lines are drawn taut.

(7) *Insert side-wall upright poles.* Place the four side-wall upright poles, one at each corner, in a vertical position with the spindle inserted through the grommet in the tent.

(8) *Drive remaining pins and adjust lines.* Drive a small wall pin through each remaining foot stop and a large pin for each eave line in line with the four corner-line pins already driven. Place the eave lines over the lower notches of the large pins and draw all the lines taut.

29. STRIKING. a. Remove pins. Remove all pins except those of the four corner lines and the two rear corner wall pins. Pile them, or place them in a container.

b. Remove the four side-wall upright poles.

c. Lower tent. With one man holding each corner line, slowly lower the tent to the rear. Fasten the poles together and collect the remaining pins.

30. FOLDING. a. Procedure for each tent. (1) *Pull canvas smooth.* Pull the back wall and top canvas out smooth. This is done by leaving the rear corner wall pins in the ground with the foot stops attached. One man at each corner line and one or two men holding the chain and plate assembly perpendicular, pull the canvas to its limit away from the former front of the tent. This places the three remaining sides of the tent on top of the rear side, with the door side in the middle.

(2) *Straighten right side of tent.* To straighten the right side wall and top canvas, carry the right front corner over and lay it on the left front corner. Pull the canvas smooth and the bottom edges even. Throw the eave lines toward the chain and plate assembly. Return the right front corner to the right in order to cover the right rear corner. This folds the right side of the tent on itself with a crease in the middle. This fold will now be under the front side of the tent.

(3) *Straighten left side of tent.* To straighten the left side wall and

top canvas, carry the left front corner to the right and rear in a similar fashion. This will leave the front and rear sides of the tent lying smooth and flat and the two side walls folded inward, each on itself.

(4) *Make sure the sod cloth is folded under all around the tent.*

(5) *Fold tent lengthwise.* Fold in the bottom of the wall approximately 1 foot. Fold the chain and plate assembly downward toward the bottom of the tent. Place the hood on the chain and plate assembly. The tent is now folded with the chain and plate assembly as a core, all folds being placed down flat and smooth and parallel to the bottom of the tent. If each fold is compactly made and the canvas is kept smooth, the last fold will exactly cover the lower edge of the canvas.

(6) *Arrange lines on tent.* Lay all the exposed eave lines, except the two on the center panel, along the folded canvas. Pull these two out and away from the bottom edge to their extreme length so that they may be used later for the final tying of the bundle.

(7) *Complete folding of bundle.* Fold the bundle from one end toward the center at the first seam (that is, the seam joining the first and second panels). Fold the bundle again toward the center so that the canvas already folded will come within about 3 inches of the middle panel. Fold the bundle once again to the far seam of the middle panel. Starting from the opposite end of the bundle, fold the first panel width in half. Fold this again. This will bring it about 4 or 5 inches from the part of the tent already folded from the first end. Throw this second fold completely over the part already folded.

(8) *Tie bundle.* Draw the exposed eave lines taut toward and across one another so that they are at right angles. Turn the bundle over on the eave lines. Cross the lines again on the new top of the bundle. Turn the bundle over again on the crossed lines and tie the lines with a slipknot.

b. Bundle. (1) When properly tied and pressed together the bundle will be about 11 by 23 by 34 inches.

(2) The unit designation, stenciled on the upper half of the middle width of canvas in the back wall, will appear on the exposed top of the bundle.

Section III. TENT, FIRE-RESISTANT, COMMAND POST, M-1942 O-D

31. PURPOSE. This tent (fig. 24) is used in theatres of operation to provide office shelter for staff sections of the several command echelons. (See fig. 25.) It will eventually take the place of the small wall tent. The command post tent is constructed so that it may be completely blacked out, and for this reason it may be safely used in the combat area without fear of observation. When necessary, this tent may be used for the quartering of two officers.

32. CHARACTERISTICS. **a.** This tent is 7 feet wide, 11 feet 10½ inches long, and 7 feet high.

b. The floor space is 84 square feet.

c. The tent has an entry 26 inches wide which extends along one end and partly along one side.

d. The top, side walls, and all reinforcements are made of 12.29-ounce duck and the sod cloth is made of 9.85-ounce duck. This tent comes in

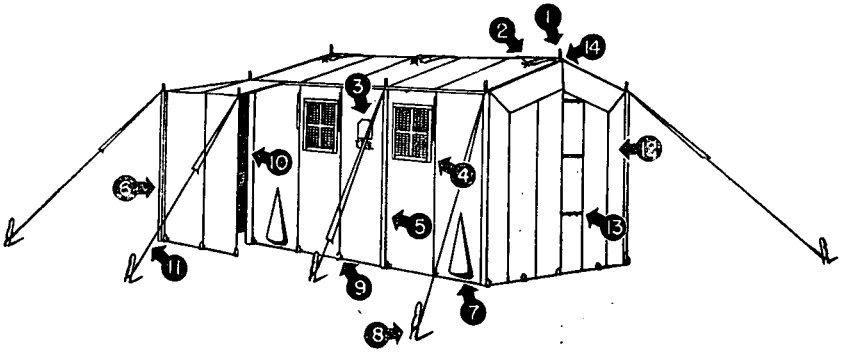

Parts	Quantity	Stock No.
1. Spindle.		
2. Ventilator, ridge -----	3	
3. Communication pocket flap.		
4. Sashes, window, tent, command post, M-1942 -----	8	24-S-575
5. Poles, tent, upright, 6' 2" -----	6	24-P-242-75
6. Poles, tent, upright, 5' 8" -----	2	24-P-241
7. Side ventilator duct -----	4	
8. Pins, tent, 24" -----	8	24-P-59
9. Lines, tent, foot stop, 1/4" dia. (foot stop) -----	23	24-L-448
10. Entry.		
11. Lines, tent, 14', w/eye, 1/8" dia. (eave line) -----	8	24-L-565
12. Extension cloth.		
13. Door fastener.		
14. Poles, tent, upright, 7' 2", complete, jointed -----	2	24-P-246
Pole, tent, ridge 11' 10 1/2", complete, jointed -----	1	24-P-135
Pins, tent, 16" -----	23	24-P-49
Slips, tent, wire -----	8	24-S-1070
Stays, cover, ventilators, tent, command post, style 1 -----	3	24-S-1263-75
Lines, tent, 7' 6", sewed-2-end, 1/4" dia. (lacing line) -----	4	24-L-513

Figure 24. Tent, fire-resistant, command post, M-1942, o-d, stock No. 24-T-318-33.



Figure 25. This tent is used as an office.

one section, the entry being attached. There is an extension cloth on the rear end wall which makes it possible to combine two command post tents when a larger tent is desired.

e. It has a ridge height of 7 feet and a wall height of 6 feet. This gives a pitch of 1 foot. This makes an almost flat top with just sufficient pitch to shed water.

f. There are two doors, one at each end of the tent. They are formed by slits in the middle of the end sections which are overlapped.

g. It has four 18-inch square windows made of flexible glass material. These windows are attached to the tent by snaps. Each window has a flap which, when rolled up, is held in place by means of tie tapes, and when rolled down, is held by means of snap fasteners. These flaps are necessary for use in a blackout. An extra set of four windows is issued with each tent. These are kept in the spare sash pocket located on the inside of the front end wall.

h. There are two circular sleeves, one in each side wall, through which messages are dropped into the tent. These are located between the two windows on either side. They have canvas flaps which hang down and cover the openings. The circular sleeves are inside the tent. The sleeves have a zipper opening. (See fig. 26.)

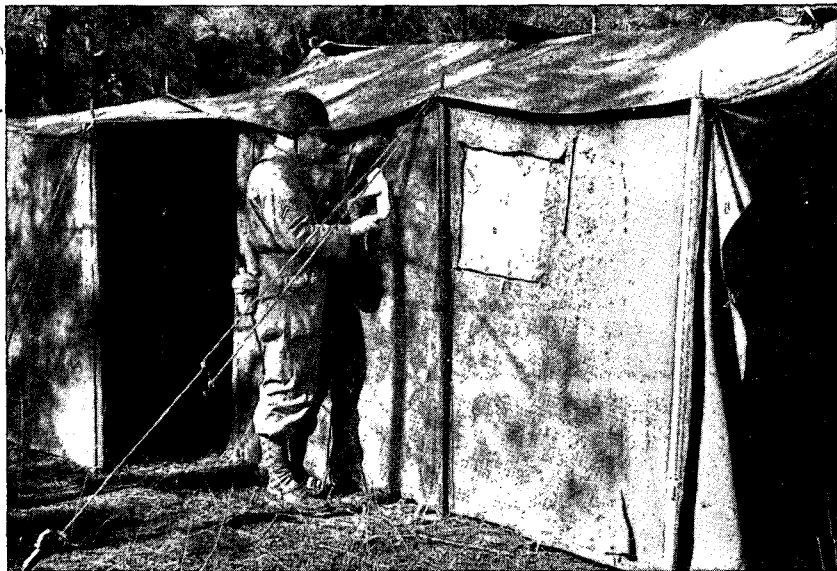

Figure 26. The communication pocket is used for delivering messages.

i. This tent is ventilated by three vents on the ridge, and by two large vents on each side of the tent at the corners near the ground.

j. Stoves will be issued for use with this tent, but there are no stovepipe openings built into it. When it is necessary to heat the tent, the stove pipe may be put through one of the window openings.

33. PITCHING. a. **Preliminary arrangements.** The officer or noncommissioned officer in charge selects suitable ground. He indicates the direction in which the tent is to face and the exact position of the

entrance. This tent is pitched by five men in approximately 30 minutes. (See fig. 27.)



Figure 27. This tent is pitched by five men.

b. Procedure. (1) *Spread canvas.* Spread the tent on the ground with the inside entrance facing the area or direction which has already been designated.

(2) *Drive corner pins.* Drive the right front corner pin, square off the tent, and drive the other three corner pins.

(3) *Drive eave-line pins on corners.* Drive the three eave-line pins on each open corner diagonally opposite each other, from right to left. Set the fourth (entrance corner) eave-line pin one and one-half upright-pole lengths from the corner pin, diagonally across from the opposite corner eave-line pin.

(4) *Adjust ridge ventilators.* Set the ventilation strips in all three ridge ventilators.

(5) *Insert ridge pole.* Open the rear door flaps and insert the ridge pole.

(6) *Adjust upright ridge poles.* Place the spindles on the two upright poles through the holes in the ridge pole and through the grommets in the tent, with the upright poles lying along the right side of the tent.

(7) *Raise tent.* Loosen the two corner pins and hold the two eave lines of the side which is still staked and raise the tent.

(8) *Adjust eave lines near the corner of tent.* Put the two corner foot stops back over the short pins and set and tighten the four eave lines near the corners (calling the outside entrance of the door a corner).

(9) *Adjust remaining lines and insert remaining upright poles.* Set the remaining eave-line pins and place the upright poles in position. Place and tighten all lines and stake the remaining wall pins. Place the window screens in position.

34. STRIKING. **a. Remove pins.** Remove all the wall pins except the two left corner pins.

b. Remove eave lines and upright poles. With two men holding the upright poles which support the ridge pole, loosen and remove all eave lines. Remove the remainder of the upright poles.

c. Lower tent. With two men holding the ridge pole supports and two men holding the eave lines at the right side corners, allow the tent to fall to the left toward the two corners which are still pinned down.

d. Remove metal strips from the ventilators.

35. FOLDING. a. Straighten canvas. Pull the ridge corners away from the pinned down side so that the bottoms of the side walls are even, the sod cloth folded under, and the ends of the tent forming a triangle to the left and right.

b. Remove two remaining corner pins.

c. Fold entrance. Fold the outside entrance across the tent side.

d. Place the loose-side eave lines on the tent.

e. Fold the tent lengthwise. Grasp each corner of the ridge and fold the tent lengthwise to a position 1 foot from the bottom of the wall. Fold in the bottom of the wall approximately 1 foot.

f. Place remaining lines on tent. Place all loose eave lines still showing, except the second from each end, on the tent fold.

g. Complete folding. Fold each end over almost to the center and then fold together, making a neat bundle approximately 15 x 28 x 30 inches.

h. Tie bundle. Tie the bundle using the two eave lines which were left loose for this purpose.

Section IV. TENT, FIRE-RESISTANT, HOSPITAL WARD, O-D, 6-FOOT 2-INCH DOOR

36. PURPOSE. This tent is used as a section of a field hospital. It is standard equipment for clearing companies, surgical hospitals, evacuation hospitals, convalescent hospitals, and certain veterinary installations. Its capacity is 20 canvas cots or 25 litters. It replaces an earlier model which will be issued until the present supply is exhausted. For all practical purposes the two tents are the same except that the doors are no longer cut back into the tent. This new model has two 6-foot 2-inch vertical doors. (See fig. 28.)

37. CHARACTERISTICS. a. This tent is 16 feet wide, 50 feet long, and 12 feet high.

b. The floor space is 800 square feet.

c. It is hip-roofed, has square ends, and is rectangular in shape.

d. The top, side walls, and all reinforcements are made of 12.29-ounce duck and the sod cloth is made of 9.85-ounce duck.

e. This tent has a ridge height of 11 feet and a wall height of 4 feet 6 inches. This gives a 6-foot 6-inch pitch.

f. It has two 6-foot 2-inch vertical doors which are located in the center of each end section.

g. A fly, which measures 26 feet $\frac{1}{2}$ inch by 53 feet, 11 $\frac{1}{2}$ inches is available for issue with this tent in theaters of operations. It will not be issued in the continental United States except for tents used to house patients.

h. The tent is ventilated through round holes at the top of the center poles, through the stovepipe openings when not in use with the stove, and through the doors at either end of the tent.

i. Three tent stoves, M-1941, with accessories, are provided for use with this tent. There are three stovepipe openings built into this tent. They are all located on one side of the ridge line and are protected by means of canvas flaps.

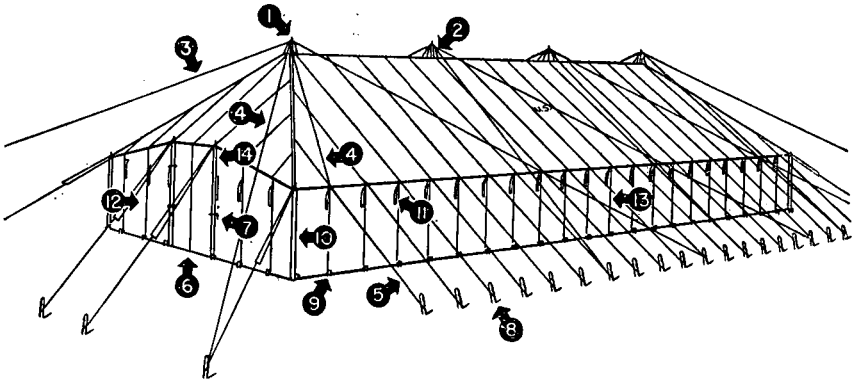

Part	Quantity	Stock No.
1. Spindle.		
2. Hoods, tent, hospital ward	4	24-H-63
3. Lines, tent, 50', sewed-2-ends, cut splice in center $\frac{1}{8}$ " dia. (guy line)	8	24-L-610
4. Lines, tent, 15', sewed-1-end, $\frac{1}{4}$ " dia. (hood line)	12	24-L-575
5. Lines, tent, 10', w/eye, $\frac{1}{8}$ " dia. (eave line)	40	24-L-540
6. Door.		
7. Lines, tent, 2' 6", sewed-2-ends, $\frac{1}{4}$ " dia. (door fastener)	22	24-L-470
Lines, tent 3' 4", sewed-2-ends, $\frac{1}{4}$ " dia. (door fastener)	20	24-L-480
8. Pins, tent, 24"	68	24-P-59
9. Lines, tent, foot stop, $\frac{1}{4}$ " dia. (foot stop)	56	24-L-448
10. Poles, tent, upright, 4' 9"	4	24-P-235
11. Wall lines.		
12. End wall.		
13. Side wall.		
14. Poles, tent, upright, 6' 2"	4	24-P-242-75
Poles, tent, upright 12' 3", complete, jointed	4	24-P-266
Pins, tent, 16"	56	24-P-49
Chains and plates, tent, hospital ward and pyramidal	4	24-C-570
Hooks, tent, end, hospital and pyramidal, $\frac{1}{4}$ "	16	24-H-165
Hooks, tent, S, style 1, tent, hospital and pyramidal	16	24-H-172
Rings, tent, galvanized, hospital ward, 10"	4	24-R-80
Slips, tent, wire	68	24-S-1070
Lines, tent, 3' 4", sewed-1-end, $\frac{1}{4}$ " dia. (door flap line)	4	24-L-479-50
Lines, tent, 6', sewed-2-ends, $\frac{1}{4}$ " dia. (lacing line)	4	24-L-500
Lines, tent, 14', w/eye, $\frac{1}{8}$ " dia. (corner line)	12	24-L-565
Fly, fire-resistant, tent, hospital ward, o-d	1	24-F-110
Poles, tent, upright, 5' 5"	12	24-P-240
Poles, tent, upright, 7'	4	24-P-245
Pins, tent, 24"	56	24-P-59
Lines, tent 10', w/eye, $\frac{1}{8}$ " dia. (eave line)	44	24-L-540
Lines, tent, 14', w/eye, $\frac{1}{8}$ " dia. (corner line)	12	24-L-565

Figure 28. Tent, fire-resistant, hospital ward, o-d, 6-foot 2-inch door, stock No. 24-T-319-5.

38. PITCHING. a. Preliminary arrangements. The officer or noncommissioned officer in charge selects suitable ground and designates the direction in which the tent will face. He then places a marker for the right front corner pin. This tent is pitched by a detail of eight men in approximately 90 minutes.

b. Procedure for each tent. (1) Drive the right front corner pin in at the marker.

(2) Spread canvas. Unroll and spread the tent over the area it is to occupy. Place all hoods and ventilator hood lines at the front of the tent and pull out the doors of the tent. Have all men go to the side

of the tent, grasp the wall which is on top, and pull it to the left so that the inner surface of the tent is on the ground. Then have the men drop the wall, walk to the other side, grasp the other side of the wall, and pull it into position so that the right front corner wall foot stop can be put on the right front corner pin.

(3) *Tie doors.* Tie the doors by overlapping the folds and insert a short pin through the foot stops on each side of the junction of the door.

(4) *Drive left front corner pin.* Insert the short pin through the left front corner foot stop and pull the front of the tent taut. When the officer or noncommissioned officer in charge aligns the tent, move the pin in 16 inches toward the right front corner for slack, and drive it in.

(5) *Drive left rear corner pin.* Stretch the tent to the left and rear to the fullest extent and insert a short pin through the left rear corner foot stop. Move the left rear corner foot stop 8 inches toward the center of the tent, and drive the pin in.

(6) *Unroll hoods and ventilator hood lines.*

(7) *Drive remainder of pins.* Secure pins for the sides and ends of the tent, long pins for each eave line along the eave-pin line and short pins for the others. The position of the corner-line pins is four and one-half long-pin lengths from the corner pins and in line with the eighth foot stop of the opposite side of the tent. Drive the wall pins straight into the ground, one for each foot stop. In driving the eave-line pins, drive one in line with each foot stop and on the line of eave-line pins which extends between all corner-line pins.

(8) *Adjust guy lines.* Place the guy lines, fully slackened and in proper order, under the second notch of the guy pins. Make certain that the correct line—the one sewed into the canvas and extending to the chain and plate assembly—is used as the corner guy line.

(9) *Untie the doors and remove the four corner foot stops from the corner wall pins.*

(10) *Insert center poles.* Insert the center poles through their respective chain and plate assemblies, pulling the butt of the pole through the assembly first, and then pushing the spindle back through the hole in the center of the plate. Do this while the tent is flat on the ground and the poles are in a horizontal position.

(11) *Place the hoods on their poles with the openings to the left and secure and place the two ventilator hood lines over the spindle of the pole.*

(12) *Raise tent.* Have all men go under the tent and raise each pole about 4 feet. (The officer or noncommissioned officer in charge checks the ventilator hood, and guy lines on each pole before the tent is raised.) Raise the tent by elevating the poles to a vertical position, one man raising each pole while another man walks forward to a position directly under the chain and plate assembly, keeping the bottom of the pole on the ground.

(13) *Adjust lines.* As soon as the tent is raised, place the corner lines over the corner-wall pins and tighten them. Place all foot stops and eave lines over appropriate pins without tightening.

(14) *Place the corner wall poles and door poles in position.*

39. STRIKING. a. Remove all foot stops and pull all wall pins except those at the right front and right rear corners.

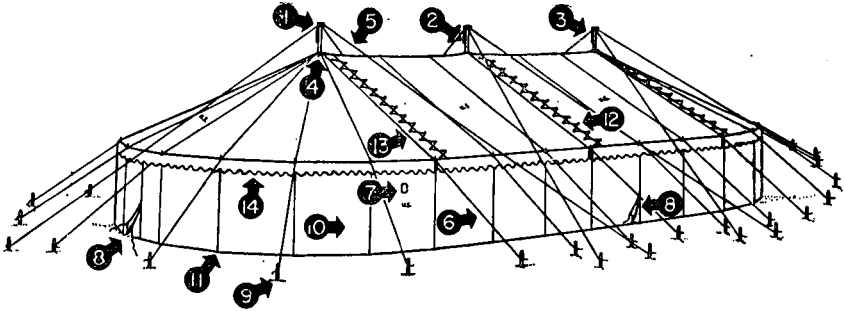

Part	Quantity	Stock No.
1. Ferrule.		
2. Blocks and hoisting line.		
3. Poles, tent, upright, 21' -----	3	24-P-295
4. Rings, tent, galvanized, assembly, with 3 loops. 10" (bail ring) -----	3	24-R-70
5. Lines, tent, 52', w/thimble and hook, 1/2" dia (guy line) -----	9	24-L-611
6. Lines, tent, 18' 6", sewed-1-end, 1/2" dia. (eave line) -----	30	24-L-580-85
7. Stovepipe openings -----	4	
8. Door openings -----	4	
9. Pins, tent, 3/6" -----	40	24-P-65
10. Side wall.		
11. Poles, tent, upright, 8' 3" -----	30	24-P-249
12. Lines, tent, 27', sewed-1-end, 1/4" dia. (lacing line, extension cloth) -----	6	24-L-582-50
13. Extension cloth.		
14. Curtain.		
Blocks and tackle, tent, assembly -----	3	19-B-13035
Chains and hooks, tent, assembly -----	3	24-C-560
Hooks, tent, wall, section assembly -----	64	24-H-180
Lines, tent, 3' 4", sewed-1-end, 1/4" dia. (wall tie line) -----	36	24-L-479-50
Lines, tent, 4' 7", sewed-1-end, 3/8" dia. (tie line) -----	12	24-L-490-85
Lines, tent, 6', sewed-1-end, 1/4" dia. (wall tie line) -----	4	24-L-499
Lines, tent, 6', sewed-1-end, 1/2" dia. (lacing line, neck center section) -----	4	24-L-499-25
Lines, tent, 12', sewed-2-end, 1/2" dia. (lacing line, neck end section) -----	2	24-L-551-50
Lines, tent, 6' 2", sewed-1-end, 1/4" dia. (jumper line) -----	30	24-L-503-50
Lines, tent, 85', sewed-1-end, 1/2" dia. (hoisting line) -----	3	24-L-620
Thimbles, tent, malleable iron, galvanized, 1 3/4" -----	52	24-T-337-25
Thimbles, tent, malleable iron, galvanized, 2 1/4" -----	24	24-T-337-33
Thimbles, tent, malleable iron, galvanized, 3" -----	4	24-T-337-45

Figure 29. Tent, fire-resistant, assembly, o-d, tent only, stock No. 24-T-318.

- b. Remove the corner wall poles and door poles and carry them and also the short pins to the front of the tent.
- c. Slacken all guy lines fully and untie all ventilator hood lines.
- d. Have all men go into the tent and move the bottoms of the poles about 24 inches to the left.
- e. Have one person grasp the inner rope of the ventilator hood line ready to pull the hood from the pole when the tent is struck.
- f. Carry the poles to the left, out under the left side of the tent. Carry the poles to the front of the tent and pile them.
- g. Drop the hoods.
- h. Remove all of the long pins, disengaging the eave lines from the pins. Remove the pins in the same order they were driven (leaving just the right front corner wall pin and right rear corner wall pin), and bring them to the front of the tent.
- i. Roll up the hoods and ventilator hood lines and bring them to the front of the tent.

40. FOLDING. a. Drag the tent to the right as far as the two remaining wall pins will permit. This action folds the tent with the inner surfaces together.

- b. Pull the remaining corner wall pins out.
- c. Straighten out the door and the walls of the tent and fold the sod cloth under.
- d. Have all men walk in toward the center of the tent drawing the doors in.
- e. Have all men go to the bottom of the tent and, grasping the walls, fold them inward until the inside of the eave seam is exposed.
- f. Have all men now go to the top of the tent, grasp it, and make two 18-inch folds, bringing the top of the tent to the edge of the upturned wall.
- g. Throw in all guy lines (except the front four), the hood lines, and the ventilator hood lines. Distribute them along the tent.
- h. Have the entire detail fold the top folds under the walls.
- i. Force out all the air within the tent by taking short steps down the tent.
- j. Fold the tent into a drum-shaped roll starting from the rear.
- k. Using the four loose guy lines, secure the tent roll by crossing the lines at right angles about the roll. Tie with a slipknot.

Section V. TENT, FIRE-RESISTANT, ASSEMBLY, O-D, TENT ONLY

41. PURPOSE. This tent (fig. 29) is authorized for the use of chaplains in the field, but is also used for the showing of movies, for lectures, for storage, for truck maintenance, or for any other purposes authorized by the commanding officer. It has a seating capacity of approximately five hundred. If the tent is used for quartering personnel it has an approximate capacity of eighty.

42. CHARACTERISTICS. a. This tent is 40 feet wide, 80 feet long, and 18 feet high.

- b. The floor space is approximately 2,857 square feet.

c. It is a circus-type tent, with a rectangular-shaped center section and rounded ends, which are hip-roofed. The top is made in four sections which lace together. There are two rounded end sections and two center sections. The side wall comes in four sections.

d. The top is made of 12.29-ounce duck and the wall sections and the curtains are made of 9.85-ounce duck. This tent does not have a sod cloth.

e. The three main center poles are 21 feet in length and the wall height is 8 feet. When the peaks or bail rings are set by means of block and tackle, the height from the ground to the top of the tent ridge will be 18 feet, with the additional 3 feet of the main poles sticking up above the top to accommodate the block and tackle. This gives the tent a pitch of 10 feet.

f. This tent has four entrances, each of which is made by the overlapping of a panel and a half of side wall where two sections of the side wall meet. These side walls may be shifted so that the openings may come anywhere as long as the same proportionate distance between the openings is maintained. However, the walls must always be started at a pole and end between the poles.

g. There are four built-in ventilators, one to each piece of side wall. The tent may also be ventilated by rolling up the side walls and tying them with the attached tie tapes, or if it is raining, by extending the side wall and tying it to the lines running from the eaves. The four doors may also be tied back and the openings used for ventilation.

h. Four M-1941 tent stoves are used to heat this tent. The built-in ventilators are used as stovepipe openings when stoves are being used.

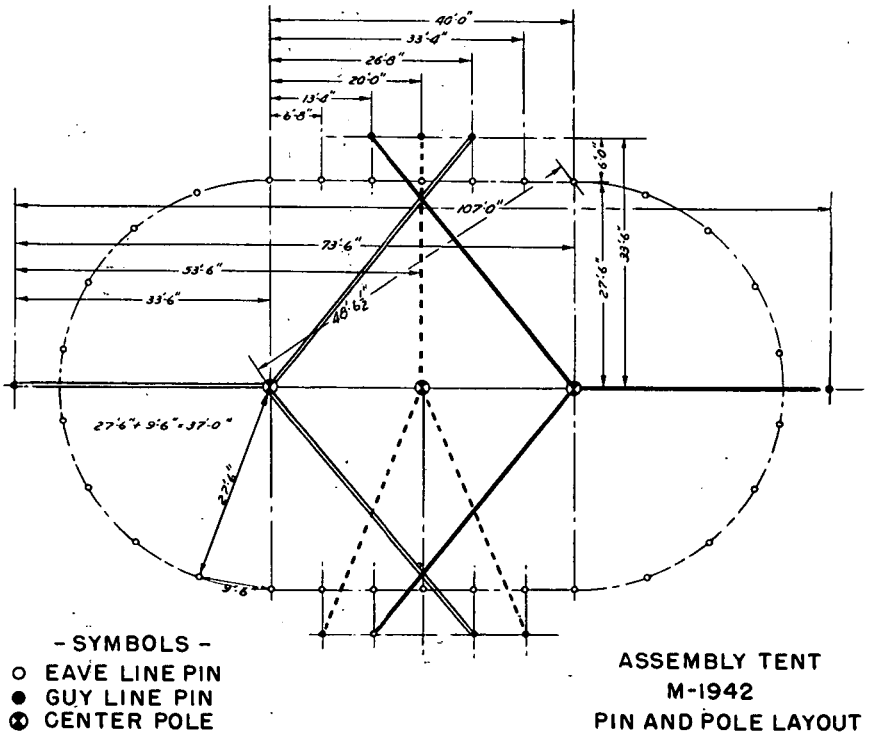

Figure 30. Pin and pole lay-out.

43. PITCHING. a. Preliminary arrangements. The officer or noncommissioned officer in charge selects suitable ground and designates the direction in which the tent will face. He then places a marker for the front center guy-line pin. This tent is pitched by a detail of eight men in approximately 90 minutes. The pin and pole lay-out (fig. 30) should be followed closely in the following procedure. If measuring devices are absent, pacing the distance off will be satisfactory.

b. Procedure for each tent. (1) *Drive guy-line pins.* Lay out and drive the outer line of guy-line pins. There are nine of these, three for each main center pole.

(2) *Drive eave-line pins.* Lay out the 30 eave-line pins, and be sure that when these are driven they are perpendicular and that the top of each pin is no more than 10 inches from the ground.

(3) *Spot center pole and prepare for erection.* Spot the three main center poles and place a marker at each location. Attach all rigging, which consists of three main top guy lines and one set of block and tackle for each pole. While these poles are still lying on the ground, insert the butt of the pole through the bail ring and attach the ring of the bail ring assembly to the hook of the single block. Lash this into position approximately 1 foot from the ground by using the drift line of the tackle. At this point the three main poles will be lying on the ground running perpendicular to the eave-line pins on one side of the tent area.

(4) *Raise front center pole.* (a) *Allocate personnel.* Place one man at the butt of the front center pole, one man at the head of the pole, and one man at each of the three guy lines. One of these guy lines leads to the outside pin on the direct center line of the long dimension of the tent lay-out. This would place the man handling the line directly in line with the man at the butt of the pole.

(b) *Place base of pole in position.* Have the man at the head of the pole raise it high enough for the man at the butt of the pole to get a purchase on it so that by holding it with his foot he may place the pole in the position designated by the marker.

(c) *Raise pole to vertical.* After the pole reaches such a height that it might swing off center, have the other two men holding guy lines spread out slowly to keep the pole balanced until it is in a perpendicular position. When this is completed, the three guy lines will be located at approximately 120° from each other and will extend 6 feet beyond the position of the eave-line pins.

(5) *Raise two other center poles.* The next main pole in line is erected in the same manner as above, with the exception that when the two guy lines in the rear of the pole are set, they should be 26 feet

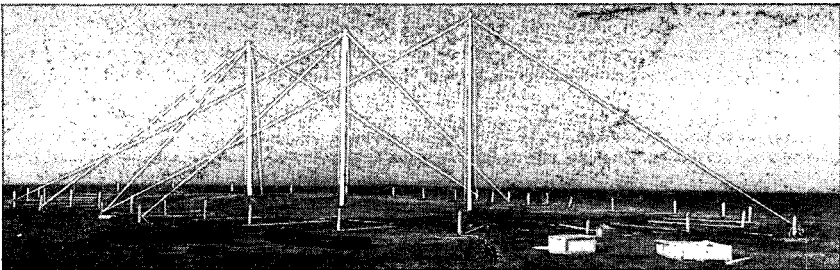

Figure 31. The pins and poles are erected.

8 inches apart. The third main pole or end pole is erected in the same manner as the first described. (See fig. 31.)

(6) *Spread canvas.* To spread the canvas, unfold the two parts of the center section first and then the two end pieces. Fasten all lanyards, both on the end and center section, to the bail rings. This is accomplished by passing the neck lace line around the bail ring and through the thimbles, which are attached to the top reinforcing lines of the tent. Lash the neck line of the round end section to the neck line of the center section and then to the bail ring.

(7) *Lace sections together.* Lace together the sections of the tent from the ridge to the eave reinforcement line.

(8) *Lash thimbles together.* Lash the two thimbles together by means of the tie line which is spliced through the thimble at the end of the eave reinforcing line on the becket side to the thimble on the grommet side. This is spliced into the top reinforcement line on the center section.

(9) *Attach eave lines.* After completing the lashings and lacings, attach, by means of two half-hitches, all eave lines to the pins approximately 2 feet in from the end of each line. This operation is completed 30 times, or once at each pin.

(10) *Insert upright poles.* Raise the canvas and slide the butt end of the 8-foot 3-inch uprights toward the center pole. Raise the canvas and insert the pin of the upright through the leather reinforcement at the point where the eave line is attached to the top. This is repeated in 30 places.

(11) *Prepare to raise canvas.* Raise the peaks of the tent about 3 feet off the ground, being sure that the drift line of the tackle assembly is inside of the bail ring and next to the center pole. This operation is repeated for each main centerpole. Raise the outside of the tent at the eave reinforcing lines by drawing the upright poles to a position forming an angle of about 60° with the ground, with the butt of the pole pointing toward and in line with the butt of the center pole. Fasten the jumper line to the pole by means of two half-hitches. This operation is repeated 30 times. (After this operation is completed, the tent should present a deep-dish or bowl effect.)

(12) *Partially tighten all eave lines.*

(13) *Raise peaks.* With the man handling the drift line standing directly at the foot of each pole, raise the peaks or bail rings by means of block and tackle to within 3 feet of the top of each center pole. The three peaks of the tent should be raised at the same time.

(14) *Straighten upright poles and tighten lines.* Straighten all upright poles to a perpendicular position and tighten all eave lines as much as possible in order to eliminate wrinkles in the tent roof. (See fig. 32.)

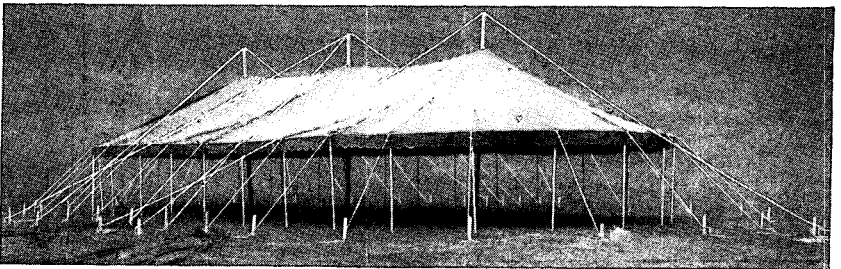

Figure 32. The roof is erected.

(15) *Attach side walls.* Attach the side walls by hooking the wall hooks on the top of the side walls through the wall ring chapes which are attached to the top.

44. STRIKING. **a. Check guy lines.** Check all main pole guy lines, being sure they are lashed to the poles and are taut.

b. Detach all side walls.

c. Adjust side pole uprights. Slant the butts of the side pole uprights toward the butt of the center pole at a 60° angle with the ground. (If the weather is calm, untie the upright jumper rope. Do not untie this rope in a high wind.)

d. Let down peaks. Let the peaks down to ground level and, as quickly as possible, take out all side poles. Do not unfasten the cave lines from the pins. This will keep the entire canvas area in such a position that when sections are unlaced, there will be little difficulty in rolling them up.

e. Untie guy lines. After the guy lines have been untied from the pins, toss them on the canvas area, leaving out two lines on each section so that they may be used to tie the canvas into compact bundles after it has been properly folded and rolled.

f. Strike center poles. To strike the center pole, place one man at the butt of the pole and designate one person to man each of the three guy lines. Untie all guy lines. Have two men with guy lines walk slowly toward the center of the tent area, keeping lines taut to prevent the pole from swaying. The man directly behind the man at the foot of the pole walks slowly forward. This brings the pole to a horizontal position on the ground.

g. Remove all side wall upright poles.

h. Remove all pins after disengaging all lines.

45. FOLDING. **a. Unlace sections.** Unlace the sections of the tent and separate them for folding into separate bundles.

b. Fold each section lengthwise. Make a complete fold of each section on its long axis and repeat this step, the folded edge being placed even with the two edges of the canvas. After each fold smooth out the canvas carefully.

c. Complete folding. Begin at one end and continue folding toward the center of the tent, the edge of the last fold extending about one-fourth of a seam's width beyond the center of the last panel. Do the same with the other end of the section and then place all of one folded end on top of the other folded end. The sections of the side wall will be folded in the same manner as the sections of the top. The sod cloth should be folded under and the bottom of the wall folded in approximately 1 foot as the first fold.

d. Tie bundle. Tie each bundle with the two lines which were left out for this purpose. Cross the two lines at right angles and wrap them around the sides of the folded bundle. Cross them again at right angles on the bottom side and pull them up over the ends of the tent. Insert the end of one line through the loop of the other, pull it tight, and then tie it with a slipknot.

Section VI. TENT, FIRE-RESISTANT, MAINTENANCE, SHELTER

46. PURPOSE. The maintenance shelter tent (fig. 33) was designed in cooperation with the Ordnance Department to be used in theaters of operations for the repair of M-3 tanks.

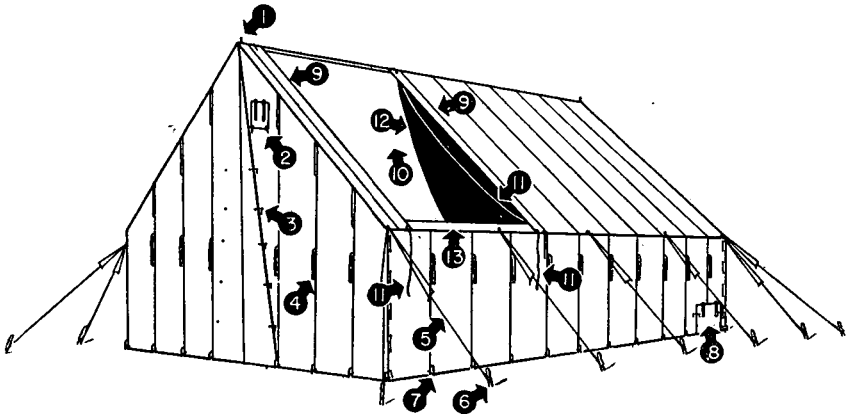

Part	Quantity	Stock No.
1. Spindle.		
2. Ventilators	2	
3. Lines, tent, 2' 6", sewed-2-end, 1/4" dia. (door fastener)	20	24-L-470
4. Wall lines.		
5. Lines, tent, 11' 6", w/eye, 5/16" dia. (cave line)	14	24-L-550-30
6. Pins, tent, 24"	18	24-P-59
7. Lines, tent, foot stop, 1/4" dia. (foot stop)	38	24-L-448
8. Heater ducts.		
9. Water flaps.		
10. Roof opening.		
11. Upper and lower pull tabs.		
12. Hookless fastener slide.		
13. Roof opening extension flap.		
Pins, tent, 16"	38	24-P-49
Lines, tent, 3' 4", sewed-1-end, 1/4" dia. (door flap line)	4	24-L-479-50
Lines, tent, 4", sewed-1-end, 1/4" dia. (water flap line)	2	24-L-482-75
Lines, tent, 4' 6", sewed-2-end, 1/4" dia. (door lacing line)	2	24-L-470
Lines, tent, 7' 6", sewed-2-end, 1/4" dia. (lacing line)	4	24-L-513
Lines, tent, 14', sewed-1-end, 1/4" dia. (lower draw line)	2	24-L-564-40
Lines, tent, 15', sewed-1-end, 1/4" dia (opening flap lacing line)	1	24-L-575
Lines, tent, 17' 6", sewed-1-end, 1/4" dia. (lacing line)	2	24-L-580-20
Lines, tent, 19', sewed-1-end, 1/4" dia. (lacing line)	2	24-L-581-25
Lines, tent, 27', unfinished-2-end, 1/4" dia. (upper draw line)	2	24-L-583-21
Lines, tent, 64', sewed-2-end, cut splice in center, 5/16" dia. (guy line)	2	24-L-614
Frame, tent, maintenance shelter	1	24-F-675

Figure 33. Tent, fire-resistant, maintenance shelter, stock No. 24-T-319-15.

47. CHARACTERISTICS. a. This tent is 18 feet 2 1/2 inches wide, 26 feet 2 1/2 inches long, and 13 feet 7 inches high.

b. The floor space is 277 square feet.

c. It is an A-type, square-end tent, rectangular in shape. It is designed to be erected over a steel frame which is supplied for this purpose.

d. The tent comes equipped with a box steel frame weighing approxi-

mately 500 pounds. (See figs. 34 and 35.) This frame is equipped with floating nuts and bolts.

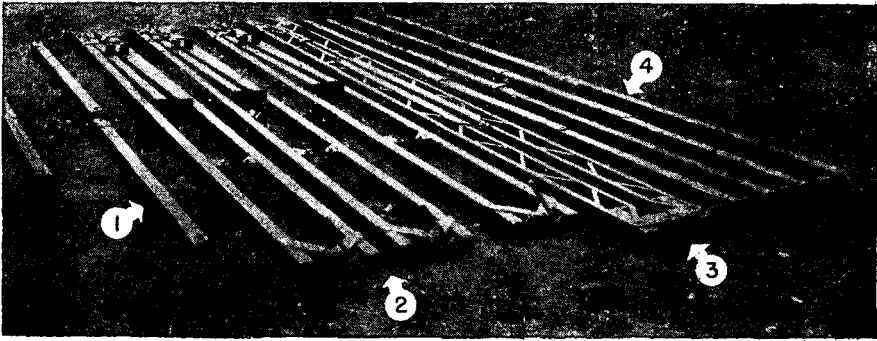

1. Three truss braces.
2. Three truss and end post assemblies.
3. Ridge pole frame assembly.
4. Four eave strut assemblies.

Figure 34. Component parts of frame, tent, maintenance shelter, stock No. 24-F-675.

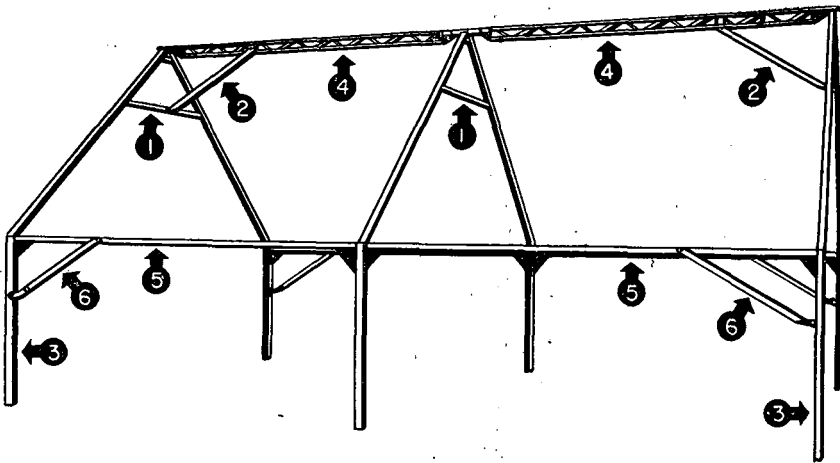

- | | |
|----------------------------|-------------------------------|
| 1. Truss braces. | 4. Ridge pole frame assembly. |
| 2. Ridge pole knee braces. | 5. Eave strut assembly. |
| 3. End posts. | 6. Side knee brace. |

Figure 35. Box steel frame erected.

e. The top, side walls, and all reinforcements are made of 12.29-ounce duck. The sod cloth, which is 29½ inches wide, is made of 9.85-ounce duck. There are six ground sheets measuring 4 feet by 12 feet, provided with each tent to form a floor. These are made of No. 6 duck.

f. The tent has a ridge height of 13 feet 7 inches and a wall height of 5 feet 6 inches. This gives a pitch of 8 feet 1 inch.

g. The tent is equipped with a 9-foot by 10-foot opening on one end of the roof. This opening extends from the ridge of the tent to the eaves, and can be opened and closed by means of two 10-foot zippers. This opening is necessary when removing or installing the vehicles'

engines. These operations are performed by means of a crane which operates from outside the tent.

h. This tent is heated by a gasoline-burning heater which is set up on the outside of the tent. The heat is forced into the tent through a large canvas tube attached to the heater ducts provided for this purpose.

i. The tent is equipped with two canvas ventilators, one at each end of the tent near the ridge pole. There are also four heater ducts to accommodate the equipment used with the heating apparatus. Two of these heater ducts are located on the side walls at each rear bottom corner of the tent. When these ducts are not in use, they are covered by means of canvas heater-duct flaps.

48. PITCHING. a. Preliminary arrangements. The officer or noncommissioned officer in charge selects suitable ground and indicates the direction in which the tent will face. This tent, including the steel frame, is pitched by a detail of six men in approximately 75 minutes.

b. Procedure for each tent. (1) *Lay out frame.* Lay out various sections of the frame in their relative positions ready for erection.

(2) *Erect end sections.* Spread the front and rear end sections and attach the truss braces. Placing the section in a perpendicular position fold under the right and left end posts so that these two pieces, to which two side knee braces are connected, lie flat on the ground, giving the resulting triangle an A-shaped appearance.

(3) *Attach the ridge-pole frame and ridge-pole knee brace to the end sections.*

(4) *Insert the center A-truss assembly.*

(5) *Attach the four eave strut assemblies, two to each long side.*

(6) *Spread canvas over frame.* Unfasten the doorways of the tent, both front and rear, and spread the top of the tent over the ridge pole, being sure that the grommets in the deck at the ridge are centered over the spindles on the ridge pole. This will give an A-shaped tent with the side walls lying loosely on the ground and the peak of the tent approximately 7 feet from the ground. (See fig. 36.)

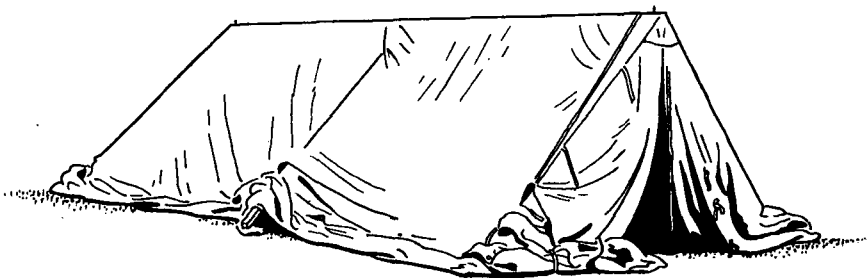

Figure 36. Pitching the tent; the tent assumes an "A" shape.

(7) *Lash canvas to frame.* Inside the tent make all lashings around various sections of the frame structure, using for this purpose the lace lines which are held by the canvas lugs sewed to the tent.

(8) *Raise sides of tent.* After securely fastening all lace lines, proceed to the outside of the tent, all members of the erecting crew going to one of the sides of the tent with two men to each end post. Raise this side to the full 5-foot 6-inch height of the side wall and secure the side

knee braces. (See fig. 37.) Duplicate this operation on the opposite side of the tent.



Figure 37. Pitching the tent; a side wall is raised.

(9) Drive in all pins and secure the eave lines.

(10) Line up the side wall and secure it with the small-sized pins through the side wall foot stops.

49. STRIKING. a. Unfasten all eave lines and remove all pins including side wall foot stop pins.

b. Loosen side line braces and lower one side so that the side wall is lying loosely on the ground. Repeat this operation with the opposite wall. This will bring the tent back to the position shown in figure 36.

c. Untie the lace lines and remove all lashings from around the various sections of the frame structure.

d. Open the front and rear doors of the tent and slide the deck of the canvas off the ridge pole. Carry the canvas completely away from the frame.

e. Separate the frame by reversing the procedure used to erect it. (See par. 48b (1) through (5).)

50. FOLDING. a. This tent is folded in the same manner that the wall tents (par. 20) are folded.

b. The steel frame should be completely broken down into sections and assembled for shipment. (See fig. 34.)

Section VII. TENT, FIRE-RESISTANT, SURGICAL TRUCK, O-D

51. PURPOSE. This unit (figs. 38 and 39) is designed to fit over the body of a surgical truck. The tent is used as an emergency operating center in forward combat areas.

52. GENERAL FACTS. a. This tent is 22 feet wide, 26 feet long, and 10 feet high.

b. It has a floor space of 481 square feet.

c. It is rectangular in shape.

d. The top, side walls, and all reinforcements are made of 12.29-ounce duck and the sod cloth is made of 9.85-ounce duck.

e. This tent has a ridge height of 10 feet and a wall height of 5 feet 6 inches. This gives a pitch of 4 feet 6 inches.

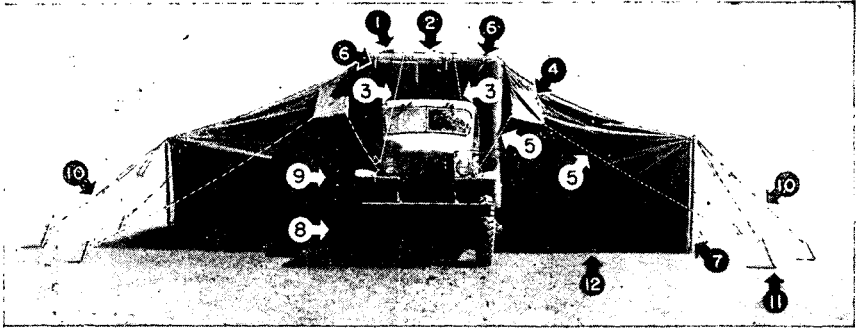

Part	Quantity	Stock No.
1. Tank opening cover.		
2. Hood.		
3. Lines, tent, 20' 6", sewed-1-end, $\frac{5}{16}$ " dia. (ridge tie line)---	2	24-L-581-45
4. Awnings	2	
5. Lines, tent, 14', sewed-1-end, $\frac{1}{4}$ " dia. (awning tie line) ---	4	24-L-564-40
6. Retaining straps.		
7. Poles, tent, upright, 5' 8" -----	10	24-P-241
8. Curtain, lower front, blackout		
9. Curtain, upper front, blackout		
10. Lines, tent, 11' 6", w/eye, $\frac{5}{16}$ " dia. (cave line) -----	12	24-L-550-30
11. Pins, tent, 24" -----	12	24-P-59
12. Lines, tent, foot stop, $\frac{1}{4}$ " dia. (foot stop) -----	22	24-L-448
Curtain, rear blackout.		
Pins, tent, 16" -----	22	24-P-49
Slips, tent, wire -----	12	24-S-1070
Lines, tent, 7' 6", sewed-2-end, $\frac{1}{4}$ " dia. (lacing line)-----	4	24-L-513
Lines, tent, 9' (sewed-1-end, $\frac{1}{4}$ " dia. (upper front blackout curtain draw line and rear blackout curtain tie line) -----	1 1	24-L-529
Lines, tent, 10' 5". sewed-1-end, $\frac{1}{4}$ " dia. (front blackout flap tie line) -----	1	24-L-543-45

Figure 38. Tent, fire-resistant, surgical truck, o-d, stock No. 24-T-321-40.

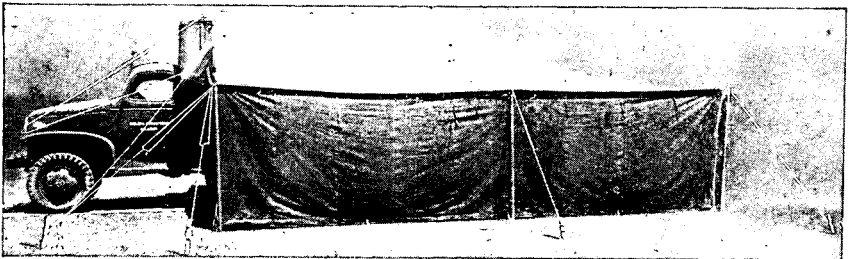

Figure 39. Side view of the tent, fire-resistant, surgical truck, o-d.

f. The truck supports the top of the tent in place of a ridge pole. The outside edges of the tent are held in position by upright poles, cave lines, and pins. The center front section of the tent is attached by means of webbed straps to metal buckles on the front end of the truck top. For extra security two guy lines are run from the ridge and tied to metal hooks on the outside of each headlamp.

g. It has one door which is 5 feet $7\frac{1}{2}$ inches high and 4 feet 8 inches wide. This is located in the center of the rear (end opposite front of truck) of the tent.

h. The tent comes equipped with three blackout curtains: one rear, one upper front, and one lower front. The two front curtains are so located that they fill in the spaces between the bottom of the body of the truck and the ground, and the other covers the back window of the cab of the truck. When all three curtains are attached, the tent may operate under perfect blackout conditions.

i. There are two ventilator openings built into the tent. These are located at the front of the tent, one on either side of the truck in the corner at the ridge line. These are covered by canvas awnings which are kept open by two lines each, one line attached to a headlamp and the other to the front tent pin. (See fig. 38.)

j. It takes four men 30 minutes to erect this tent.

k. There is no stove issued for heating this tent. A hot water heater is part of the surgical truck equipment. All operating is done in the body of the truck. The only heat in the tent itself is that which comes from the open back doors of the truck.

53. PITCHING. a. Preliminary arrangements. The officer or noncommissioned officer in charge selects suitable ground and indicates the direction in which the tent will face. This tent is pitched by a detail of four men in approximately 30 minutes.

b. Procedure for each tent. (1) Place the boards on the ground for the tires of the truck to rest upon. (See fig. 38.) This will prevent the truck from settling down into the ground.

(2) Drive the truck onto the boards which have just been put down for that purpose.

(3) Open up the rear door flap and the front blackout curtains, and spread the top of the tent over the top of the truck.

(4) Attach the front section of the tent to the body of the truck by fastening the webbed straps on the tent through the metal buckles which are attached to the truck.

(5) Tie the ridge tie lines to the metal hooks on the outside of each headlamp.

(6) Tie the rear door flap and front blackout curtains in place.

(7) Drive in all long tent pins and secure all eave lines.

(8) Place the wall poles in position.

(9) Line up the side wall and secure it with the small-sized pins through the side-wall foot stops.

(10) Attach the awning tie lines.

54. STRIKING. a. Unfasten the awning tie lines, ridge tie lines, and all eave lines and remove all pins, including side-wall foot-stop pins.

b. Remove all side-wall poles.

c. Unfasten all parts of the front section of the tent which are directly attached to the truck.

d. Open the rear door flap and the front blackout curtains, and slide the deck of the canvas from the top of the truck. Carry the canvas completely away from the truck.

55. FOLDING. This tent is folded in approximately the same manner that the wall tents are folded. Minor modifications may be necessary because of difference in shape. (See par. 20.)

Section VIII. SCREEN, LATRINE, FIRE-RESISTANT, O-D

56. PURPOSE. The latrine screen (fig. 40) is issued to units in the field for use as an outdoor latrine.

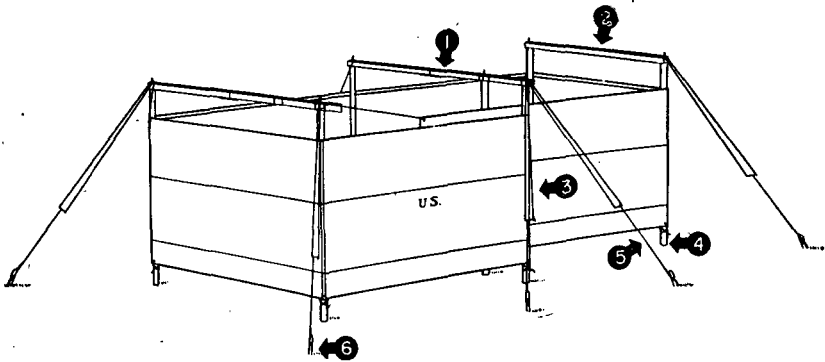

Part	Quantity	Stock No.
1. Poles, tent, ridge, 9', hinged -----	2	24-P-112
2. Pole, tent, ridge, 7' -----	1	24-P-100
3. Entrance.		
4. Poles, tent, upright, 7' -----	7	24-P-245
5. Lines, tent, 14', w/eye, $\frac{1}{16}$ " dia. (guy line) -----	7	24-L-565
6. Pins, tent, 16" -----	8	24-P-49
Slips, tent, wire -----	8	24-S-1070
Lines, tent, 3' 4", sewed-2-end, $\frac{1}{4}$ " dia. (door fastener) -----	15	24-L-480
Lines, tent, 8', sewed-1-end, $\frac{1}{8}$ " dia. (tie line) -----	1	24-L-514-40

Figure 40. Screen, latrine, fire-resistant, o-d, stock No. 24-S-760.

57. CHARACTERISTICS. **a.** It is 18 feet long, 7 feet high, and 9 feet wide at one end and 7 feet wide at the other end. This difference in width is for the purpose of forming a 2-foot entrance on one side of the screen. The entrance side of the screen consists of a 12-foot section and a 9-foot section which overlap by approximately 3 feet to give depth to the entrance.

b. This screen is made of 9.26-ounce or 9.68-ounce duck.

58. PITCHING. **a. Preliminary arrangements.** The latrine screen is pitched by a detail of six men, supervised by a noncommissioned officer, in approximately 20 minutes. The noncommissioned officer selects suitable ground, indicates the direction in which the screen is to face, the line on which it is to be placed, and the position of the inside corner of the entrance.

b. Procedure for each latrine screen. (1) Drive a tent pin to mark the inside corner of the entrance.

(2) *Unfold and place the screen in position.* Unfold the latrine screen and place the end having both a long and a short tie rope (as differing from the end having two short tie ropes) near the entrance pin.

(3) *Tie the short tie rope on the bottom of the screen to this pin.*

(4) *Lay the latrine screen on the ground following generally its final outline.* (See fig. 41.)

(5) *Assemble and raise center section.* Assemble a long ridge pole and three uprights and raise them to a vertical position near the center of the latrine screen. Hold the uprights in position and drive in two

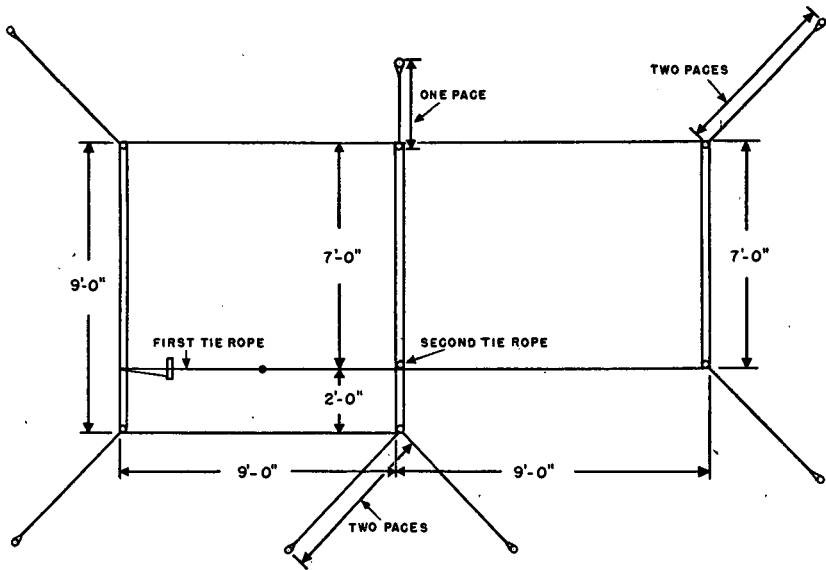

Figure 41. Screen, latrine, top view.

center guy-line pins two paces from the front center upright (outside door frame) and generally in prolongation of the diagonals from the right and left rear corners of the latrine screen through the front center upright. Drive a third guy-line pin about one pace from the rear center upright (opposite doorway) and on line with the three uprights. Place guy lines over these pins and over the upright spindles and tighten. Raise the latrine screen on the outside of the inner and rear uprights and tie it to the ridge pole with the bottom about 6 inches from the ground.

(6) *Assemble and raise narrow end section.* At the narrow end of the screen, assemble and hold in position a short ridge pole and two uprights. Drive in guy-line pins about two paces from the uprights and in prolongation of the diagonals from the inner center and rear center uprights. Attach guy lines as before. Raise the latrine screen on the outside of the uprights and tie it to the ridge pole so that the bottom is about 6 inches from the ground.

(7) *Assemble and raise wide end section.* Before assembling the long ridge pole and uprights to form the wide end of the latrine screen, loop the long tie line from the top of the inside corner of the entrance over the ridge pole. Insert the spindles of the two upright poles in the outside holes of the end ridge pole and then raise and hold in place the uprights. Drive in the two remaining guy-line pins. The four front (door side) guy-line pins are not all on the same line. (See fig. 41.) Attach and tighten the guy lines on the long end. Raise the latrine screen and tie it to the end ridge pole. Tie the outside of the entrance to the center ridge pole.

(8) *Adjust and tighten lines.* Draw the long tie line from the top of the inside corner of the entrance taut. Tie all tie lines on the lower edge of the latrine screen to the uprights. Take any slack out of the screen by a final tightening of the guy lines and if necessary by a slight shifting of the upright poles.

59. STRIKING. To strike the latrine screen, reverse the procedure for pitching the screen.

(1) *Untie all tie lines on the lower edge of the screen from the upright poles.*

(2) *Untie the outside of the entrance from the center ridge pole.*

(3) *Disassemble wide end.* At the wide end, untie the latrine screen and drop it to the ground. Detach the guy lines at the wide end and disassemble the ridge pole and two uprights and place them in a pile at one side.

(4) *Disassemble narrow end.* Untie the narrow end of the latrine screen. Detach the guy lines and place the ridge pole and uprights with the poles previously placed to one side.

(5) *Disassemble center section.* Follow the same procedure with the center ridge pole. Collect the eight tent pins and seven guy lines and place them near the ridge poles and uprights.

60. FOLDING. **a. Extend the screen on the ground and smooth it out.**

b. Make first two folds. To make the first fold pull one end over to the other. Repeat this step, placing the folded edge even with the two ends of the screen. (The screen can be better controlled if the first two folds are made into the wind.) Be sure to smooth out the canvas after each fold.

c. Continue folding. Fold either the top or bottom edge over one-third of the width of the latrine screen. Then fold the other edge completely over the first fold.

d. Place lines on screen. Put the tie lines and all guy lines, except one for tying the bundle, inside the folds at one end of the screen.

e. Form final bundle. To form the final bundle, make a 2-foot fold from each end of the screen toward the center. Repeat this step twice leaving the two folded sections 2 or 3 inches apart. Place one folded section over the other and the bundle is ready to be tied.

f. Tie bundle. Lay the guy line over the center of the bundle and turn the bundle over on the line. Cross the ends of the line over the new top of the bundle and again turn the bundle over on the crossed lines and tie them.

CHAPTER 4

TENT SITE

61. SELECTION OF SITE. Great care should be exercised in selecting the correct tent site. Battle needs, however, may often necessitate the use of poor camp sites. For an illustration of the good tent site see figure 3. Important points to remember are listed below:

a. The tent should be protected from wind and storms. Do not pitch the tent in an open field or on a ridge which offers no protection. (See fig. 42.) If the wind is cold and it is necessary to leave one end of the



Figure 42. The poor tent site.

tent open, pitch the closed end of the tent into the wind.

b. Choose high ground, if possible, because it will be drier.

c. If possible, choose an area having tough grass turf.

d. In hot weather, a shady area free of underbrush is desirable.

e. In the woods, avoid a location directly under dead trees or trees with large dead branches.

f. If the tent is being pitched by a river, lake, or other body of water, place it far enough back so that it is above the high watermark.

g. In mountainous country, avoid camping in canyons and next to dry creek beds. Such places have been known to fill up with rushing torrents in a remarkably short time.

h. Do not camp at the base of a cliff or steep mountainside where there may be danger from avalanches and rockfalls.

i. Choose level ground. The ground the tent is pitched on should be level and free from projecting roots of trees and large embedded rocks showing above the surface. This applies to an area extending about a foot beyond all sides of the walls, where a ditch should be dug to carry off water during a rain. When such a spot is not available, a

place can often be leveled and cleared with very little work. In woods, moss and rocks may be used to smooth out the irregularities in the ground. It is particularly important to level the ground when pitching a tent for sleeping purposes.

62. PITCHING A TENT IN SNOW. Before selecting a camp site on a snow-covered glacier, prod the surface with an ice or ski pole to see whether the snow conceals any crevasses. It may be impossible to find an area entirely without crevasses but in order to avoid accidents their presence should be known. When an adequate site on snow has been found, the snow should be packed hard by stamping on it with skis or snowshoes or, better still, the top snow should be shoveled off until firm snow is found below. A doorstep dug a foot below the surface of the snow makes it easier to get in and out of the tent, and to brush off snow. It is important to leave some space between the sides of the tent and any protective snow wall so that there is room to shovel out the snow which might drift in. Such a wall must not be high if snow is likely to drift. On any slope a horizontal platform should be formed. The snow which is removed may be packed around the outer edge of the platform to widen the space for the tent. The prevailing winds should be taken into consideration. (See par. 6.)

63. TRENCHING TENT. a. GENERAL. In case of doubt as to the advisability of digging a trench around a tent, a safe rule to follow is, *always dig the trench*. If the tent is set up in very sandy soil which absorbs water as fast as it falls, or if it is located on a little mound which slopes off in all directions, a trench may not be necessary. When the tent is being pitched on heavy soil, clay, or a flat rocky surface, ditches should always be dug because the surfaces of these soils hold water and will not readily absorb rain.

b. Constructing trench. (1) Dig the trench all around the tent.

(2) Do not dig the ditch in a V-shape but cut straight down, just outside the tent pins. Slope the side away from the tent inward toward this dam or straight side. (See fig. 43.)

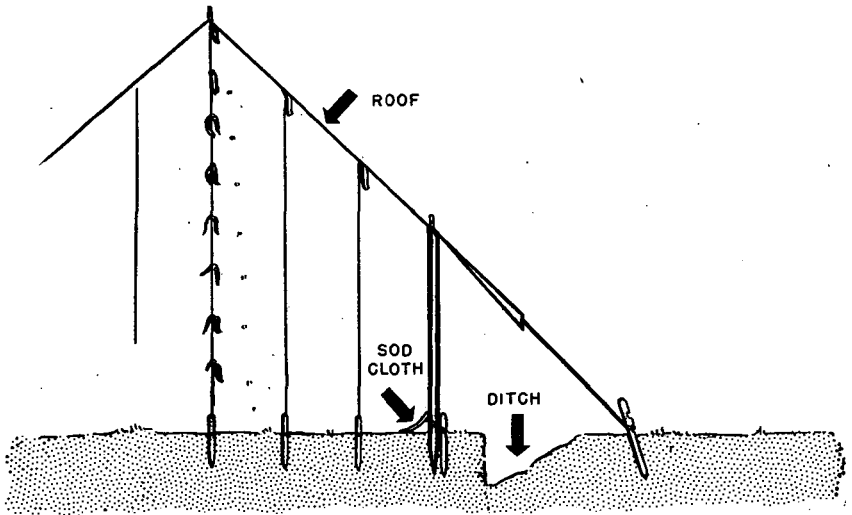

Figure 43. Cross-sectional view of tent trench.

(3) When digging a ditch cast the dirt away; never pitch it against the tent, for it will quickly rot the canvas.

(4) The ditch seldom needs to be more than 4 or 5 inches deep and in the shallowest places not over 3 inches. There should be enough slope in the ditch so that the water will flow freely toward the outlet and not back up.

(5) At the lowest point of the area an outlet trench should be dug and connected to the ditch which has been dug around the tent to carry the water off. (See fig. 44.)

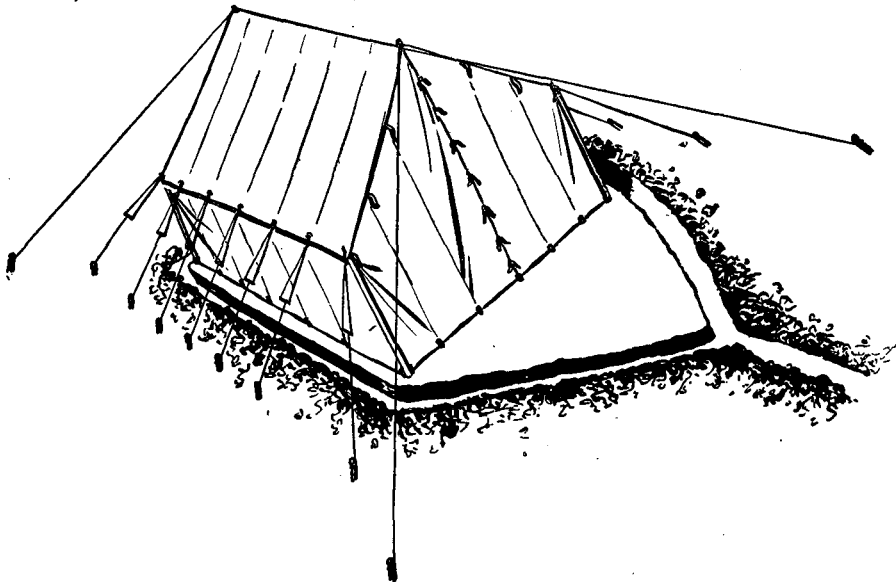

Figure 44. An outlet trench is constructed.

(6) When there is a possibility that water may flow in from higher ground, a ditch should be dug to divert the water before it can reach the tent.

CARE OF TENTAGE

64. GENERAL. The duck fabric currently procured for tentage is treated in such a way as to make it resistant to fire, water, weather, and mildew. This treatment thus reduces the danger of fire from any cause, and the danger of mildew, one of the greatest enemies of tent fabric. The coloring pigments give a dark olive-drab shade for protective coloration and make the material practically lightproof. This treatment adds 40 to 50 percent more weight to the basic fabric. All components of the tent such as rope, thread, and wood are now treated with preservatives.

a. Treatment in field. Despite all the treatments which tentage receives before issue, even the best types lose their properties somewhat after prolonged weather exposure. The life of older tentage can be extended greatly by the use of a suitable re-treating compound, "Compound, Coloring, Type 1, Color C Green," stock No. 51-C-1598 or "Compound, Re-treating, Water, Weather, and Mildew Resistant (For Cotton, Duck and Webbing)," stock No. 51-C-1608. This is a mixture of waterproofing waxes, mildew inhibitors, and coloring pigments to give the dark olive-drab shade, all carried in a volatile (also inflammable) solvent.

b. Continual care. The life of a well made tent will be in direct proportion to the care given it. This care must be continual in packing for shipment, handling during shipment, unpacking, unfolding, erecting, taking down, folding, and storing. The main factors responsible for the damage to tentage are weather, fire, mildew, and carelessness.

65. WEATHER. Wind and rain may cause extensive damage to tentage. Inasmuch as they have different effects on tents, personnel will be instructed in precautionary measures for both.

a. Rain. Rain causes the canvas and rope on the tent to shrink. Normally the lines on the tent are drawn taut to keep the tent erect. As soon as the lines become water-soaked they may become tight enough to tear the tent apart. Tents have been torn completely in two under such circumstances. There are two things that can be done to forestall such a mishap:

(1) Have the lines sufficiently loosened at all times so that when they tighten in wet weather they will not become tight enough to tear the tent. To compensate for shrinkage, all eave and corner lines should have a free swing of approximately 18 inches at the middle of the line. This does not give the tent its best appearance, but the tent serves its purpose and needs no adjustments, in either wet or dry weather. For inspection purposes, tent lines may be tightened.

(2) Place blocks, to be removed in the event of rain, underneath each upright pole. Removing the blocks automatically loosens all tent lines.

b. Wind. In a strong wind, all lines should be immediately tightened. Door flaps should be closed, walls should be secured to foot-stop pins, and all corner lacing laced. Guy ropes should be tight. These precautions will cause the wind to blow around rather than into tents.

66. FIRE. a. General. Tentage which has been given the treatment to make it fire-resistant will not burst into flame but will burn and char slowly. The fact that a tent is marked "Fire-resistant" does not signify that it will not burn. Precautionary measures are still necessary. Tent fires are usually caused either by some individual's carelessness or by failure to use the spark arresters generally issued with tent stoves. Do not neglect to use them. Clean the screen-type arrester at regular intervals. Be sure that the fire in the stove is out before removing the arrester. If spark arresters are not available they must be improvised from a fine-mesh wire screen or other suitable material.

b. Fire extinguishers. Use only those extinguishers whose contents are not injurious to the fabric of tents. This is important to remember because some fire extinguishers contain acids or solvents which will ruin tent materials. Tent areas should be provided with fire extinguishers which contain only water, or water and a harmless antifreeze.

67. MILDEW. a. General. More good tents have probably been ruined by mildew than by any other single agent. Mildew has been known to ruin the best of tents in 3 days. Canvas is at all times inoculated with airborne micro-organisms which are ready to cause mildew and rot if the proper conditions prevail. The conditions favorable to the development of these micro-organisms are found in tentage which comes in constant contact with the soil (lower portions of tent), in tentage dragged across muddy or damp soil, and in tentage which has been rolled up while wet. Because of their humidity and temperature, jungles also favor the development of mildew. Mildew inhibitors are being used in the treatment of all tentage at the present time, but they are still not completely effective. Experimentation in this field is being carried on constantly.

b. How to prevent mildew. If a tent is given the proper care, mildew will not do much damage, except in tropical areas, even when the tentage has not been treated. Follow the rules below at all times and damage caused by mildew will be negligible:

(1) Never roll up a tent when wet. Even if it is only damp from dew, it will mildew when stacked away.

(2) Be positive that the following parts of the tent are dry:

(a) The seams and the edges—the bottom edge particularly—where the material is double.

(b) The sod cloth.

c. Do not roll up tent pins and poles with the tent. Keep them separate.

d. If a tent is pitched under trees, inspect the roof frequently to see that no harmful effects are resulting from drippings from branches or leaves. Keep the tentage clean at all times. The growth of fungi or mold is dependent to some degree on the nutrients (these may exist in the form of oil, grease, starch, tree drippings, or sizing in the fabric) which have accumulated on the surface of the tent.

e. When a tent is to be stored away, it should be hung off the ground in midday sunlight. If necessary, however, it may be dried indoors. If tentage is dried inside it should be done at a normal temperature in a well-ventilated place high enough to permit the tent to be suspended off the floor. A tent dried on the ground or left hanging outdoors until sundown might absorb enough dampness to give mildew a start.

f. In order to prevent the deterioration of tentage by mildew while in storage, the following precautionary measures should be taken:

(1) Tentage should not be dragged along the ground or permitted to come in contact with the ground while in storage. It should be stacked on dunnage, supported by 2- by 4-inch lumber.

(a) If the floor is hard-surfaced or wooden, the tentage should be at least 4 inches from the floor.

(b) If the floor is earthen, the tentage should be at least 8 inches from the floor.

(2) Only lumber that has been thoroughly cured should be used for dunnage, since the moisture contained in green lumber will promote the growth of mildew.

(3) Where dampness in the atmosphere is prevalent, dunnage should be used between each course to permit circulation of air between the blocks. The blocks should be separated and reduced to a minimum number of courses to permit passage of air on all four sides.

(4) Tents stacked near ventilators, which permit the entrance of moisture, or near any other opening where moisture in the air will condense and settle on the tentage, should be packed in bags or wrapped in waterproof coverings.

(5) Tentage received from the field should not be placed in bags until the tents are thoroughly dried and all dirt removed by stiff brushes. If any visible signs of mildew are present, the tent should be placed in the open air, preferably in the sun.

(6) When tentage is issued, that which has been in storage the longest should be issued first. To prevent the issue of newly stored tentage before the older stocks are exhausted, blocks should be marked according to the length of time the tentage has been in storage.

(7) When tentage is stored in open sheds or in tents, it should be stacked well away from the sides and ends of the shelter (preferably about 20 feet) and items not affected by moisture should be stacked between the tentage and the outer edges of the shelter.

(8) Any tentage found to be infected by mildew will be withdrawn from storage, brushed with a stiff brush, allowed to dry thoroughly, and issued immediately to installations where driest atmospheric conditions prevail. If there is no opportunity for immediate issue, this infected tentage should be segregated from the sound tentage to prevent contamination. Tents which have lost all serviceability should be salvaged or if necessary destroyed.

✓ (9) Depending on the facilities at hand, application of the re-treating compound (par. 6a) may be done on tentage which has been erected or which has been spread on the ground. Where spray equipment is available, its use is recommended provided the spray coat is brushed in thoroughly afterwards. The compound contains inflammable solvents and all work including the opening of the containers, should be done in the open away from all flame. No smoking should be allowed in the vicinity.

(a) Tentage should be dry and brushed clean.

(b) Compound should be well stirred before using to produce a uniform mixture. Clear white gasoline may be used for dilution if necessary.

(c) A moderate application should be made by spray or brush to the

outside, followed by a good brushing to attain penetration. Particular attention should be paid to the treating of seams and of areas where water leakage has occurred.

(d) The tentage should be thoroughly dried after treatment, allowing at least 2 hours for good drying conditions and more if necessary. The odor of solvents should have completely disappeared before the tentage is used, or rolled for storage.

(e) The solvents contained in the compound may tend to irritate the skin somewhat, as gasoline does. Prolonged contact should be avoided. The use of long handles on the brushes may prove convenient.

(10) Camouflage paints do not have the preservative function of the re-treating compound. In fact, camouflage paints other than those specifically intended for textiles may be harmful, particularly in regard to water resistance. When it is necessary to apply camouflage paint, or to make hospital markings on tents, use only the oleo resinate paint with water base furnished by the Engineer Corps for camouflage purposes. The official nomenclature of this paint is "Paint, Camouflage, Oleo Resinous, Emulsified, T-1279." To use this paint on tentage, mix it only with water, never with gasoline or spirit thinners.

68. CARELESSNESS. a. General. Probably the greatest amount of damage to tentage is caused by carelessness. Forgetting to loosen the lines when it starts raining, not bothering to use spark arresters, adjusting ropes carelessly, driving pins in a slipshod manner, dragging tents over rough ground—all of these cause the greatest harm to tentage. A few precautions are listed below as reminders.

b. Rules to follow. Follow the procedures for pitching, striking, and folding the various tents described in this manual. Do not try to take short cuts unless sure that no damage will be done. When tents are folded according to directions, the side walls rather than the top of the tent will be exposed. This is important in order to protect the top of the tent during handling and in storage.

(1) Observe reasonable care when pitching and striking the tent, for the material might tear on protruding pins, overhanging branches, or other objects.

(2) Never drag the tent along the ground or floor.

(3) Make sure that all the necessary parts and accessories for each tent have been issued and that they are used for their intended purposes.

(4) Pack tents carefully for shipment. Some tents are issued complete with bag. In this case, be sure to carry the tent in the bag. When no bag is issued, the tent will arrive wrapped in osnaburg or burlap. Save this material for rewrapping when the tent has to be moved again. Normally a tent should never be transported without a covering of some kind.

(5) Always pack pins and poles separately from the tent itself.

(6) Inspect the tentage at frequent intervals to make sure that it is in serviceable condition. Particular attention should be given to seams, bindings, lines, and all places where strain is exerted. Constantly be on the lookout for—

(a) Any evidence of mildew.

(b) Any foreign matter which may have collected on the tent.

(c) Small rips and holes, splitting of seams, grommets which have become loose, lines which are beginning to rot, or anything else which

does not appear to be in a normal condition. If not sure of the seriousness of the condition, never hesitate to call an officer or noncommissioned officer for confirmation of opinion.

69. REPAIR METHODS. a. General. There are three methods used in the repair of tents:

(1) Cement patching for minor repairs in the field.

(2) Hand sewing which is done mostly in the field when no equipment such as sewing machines, grommet-setting dies, and other essential machinery is available.

(3) Patching or reconstruction by the use of sewing machines. This is done in shops only.

b. Cement patches. (1) *Materials necessary.* (a) Either olive-drab or clear cement to conform to the color of the tent.

(b) Circular patches.

(c) A roller.

(d) Brushes.

(2) *Size of patch.* Three sizes of circular patches are used to repair tents as follows:

Patch No.	Diameter in inches	Maximum size of hole or rip in inches (Diameter or length)
1	3	1½
2	4¾	2⅞
3	6¼	4¾

(3) *Use.* (a) In selecting the size of the patch to use, a minimum overlap of ¾ inch on all sides of the hole or rip should be allowed.

(b) Foreign material such as dirt and grease should be completely removed from the parts of the tent to be repaired.

(c) A thin coat of cement is then applied to that portion of the tent to be covered by the patch, and to the entire surface of the patch. The first coat should be allowed to dry to a tacky state (it will usually take about 5 minutes), after which a second coat is applied. While still wet, both surfaces are pressed together by means of the roller provided for that purpose.

c. Hand sewing. In repairing a tent by hand, where no machines are available, needle and thread are used. These hand-sewn patches when properly stitched will outlast a patch put on by machine. A patch must be stitched on any hole exceeding 4¼ inches in diameter.

(1) *Material used.* (a) No. 15 sailmaker's needle.

(b) No. 5 ply, cotton, twine.

(c) Beeswax.

(d) Sewing palm.

(e) Duck, cotton, 12.29 ounces per square yard, olive-drab, fire, water, and weather resistant, mildew resistant treated.

(2) *Procedure.* Cut a piece of duck sufficiently large to overlap the hole (at least 1 inch on all sides plus ½ inch for turning under the ragged edge). Use the sewing palm and a needle with two strands of well-waxed cord. Prepare the patch by turning under the four ragged edges approximately ½ inch and sewing them (to hold the turned edges in place). Using a sailmaker's stitch sew the patch onto the tent. Begin at the top right-hand corner. For the first stitch, push the needle down

through the edge of the patch (and through the tent below) and out through the patch at a point $\frac{1}{4}$ inch diagonally below the point of entry. For the second stitch, push the needle through the top of the patch again, at a point $\frac{1}{2}$ inch from the original point of entry. Continue in the same manner until the patch has been sewed tightly against the tent. A patch sewed with this stitch is water-repellent.

d. Machine sewing. When the hole or rip is so large that machine sewing is necessary, send the tent to the nearest repair shop without delay.

CHAPTER 6

HEATING TENT

70. GENERAL. When using a stove in a tent, every precaution must be taken to avoid fires. Spark arresters must be installed and shields placed around the stovepipe openings. All personnel should be well trained in building and maintaining fires in the stove and should be familiar with all the fire regulations.

71. STOVEPIPE OPENINGS. In most cases tents have stovepipe openings which are built into the tent; these openings have canvas flap covers attached. (See fig. 45.) The openings, when not needed for use with the stove, may be used for additional ventilation.

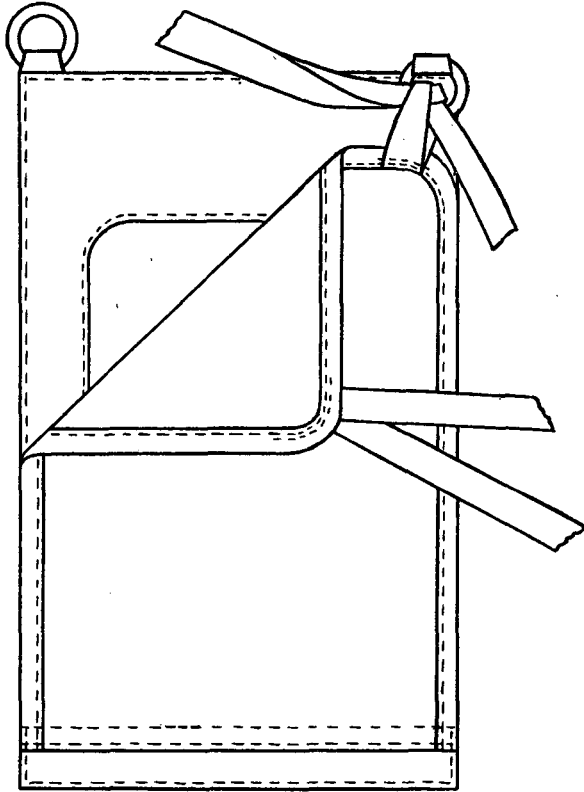

Figure 45. A stovepipe opening.

72. STOVE, TENT, M-1941. The tent stove M-1941 can be operated with wood or coal, or with an oil burner. It can be changed quickly and easily from one type of operation to the other. For information on the tent stove, see TM 10-400, "Stoves, Ranges, Ovens, and Cooking Outfits."

73. HEATING INDIVIDUAL SHELTERS. a. General. Nothing is issued by the Army for heating either the shelter tent or two-man mountain tent.

b. Expedient measures. Since these individual tents are intended for sleeping purposes, usually no heating devices are needed. However, when men are forced to stay in them for long periods of time or when the men are wet and need to dry off, they will have to use one of the following expedient measures:

(1) Build a brush fire over the area on which the tent is to be erected and keep it going for an hour or two. Clear the area of all coals and sparks and set up the tent. The ground will remain warm for several hours and the earth will be dry to sleep on.

(2) Collect stones which are 5 or 6 inches in diameter and put them in a hot fire for 2 or 3 hours before using. Roll or lift them with forked sticks into the tent. If a bucket or other metal container is handy, it may be used to hold the rocks or it may be placed upside down over them. These rocks will continue to give off heat for several hours. If there is not sufficient room to pile hot rocks in the tent safely, dig a hole and then bury the rocks even with or slightly below the surface.

(3) Although the one-burner cooking stoves issued are intended for cooking purposes, their heat will also take the chill off the inside of one of these small tents.

(4) Solidified alcohol in cans will heat a small shelter tent comfortably.

(5) A gasoline lantern is an excellent heater, and even candle lanterns will take off the chill.

74. SHIELDS AND HOODS. a. General description. Shields and hoods are made of metal and are used to protect the canvas around stovepipe openings. Hoods are used with pyramidal tents and with the old type hospital ward tents. All other tents using stoves are furnished with either round or elliptical shields. The squad tent and the new type hospital ward tent, in which the stovepipe openings are on a sloping surface, use the elliptical shields. All the other tents whose stovepipe openings are in the side wall of the tent, use the round shields.

b. Painting tent shields and hoods. (1) *General.* Shields and hoods are painted for camouflage purposes or for the reduction of glare. Material needed for this painting will be requisitioned from the Ordnance Department. An estimate of the amount of material needed to paint approximately 100 hoods or 1,500 shields is 1 gallon of paint, class 101, and 1 gallon of enamel, class 204, each mixed with 5 percent thinner.

(2) *Instructions for use.* The following instructions should be followed when painting tent hoods and shields.

(a) Take the tent hood from the tent. Paint will remove the waterproofing materials from the tent fabric and cause it to leak.

(b) Clean the entire surface with naphtha, gasoline, or other suitable solvents.

(c) When dry, apply a coat of material primer, class 101.

(d) Allow this to dry 12 hours before adding a coat of lusterless olive-drab enamel, class 204.

(e) When recoating, sand all rusted areas and give the old coat a general roughing with sandpaper before applying an added cover coat, class 204.

CHAPTER 7

LINES, TENT

75. GENERAL. Ropes are very important parts of tents and therefore should be inspected carefully. The stability and safety of the tent may depend upon the various lines used: guy lines, eave lines, foot stops, door fasteners, and others.

76. RULES TO REMEMBER AND OBSERVE IN CARING FOR ROPES. Deterioration in rope is of two kinds—mechanical and chemical. The first comes either from surface wear or from internal friction between the fibers. The second comes from exposure to weather conditions and acids. Adherence to the following rules will help to prolong the life of the rope:

a. Store rope properly. A dry, unheated building, or a room with free air circulation is the best place to store rope not in use. Place the rope in loose coils off the floor on wooden grating, or hang it on wooden pegs. It is best to hang small rope in loose coils and to coil the larger sizes loosely on a grating or platform raised from the floor to insure the necessary circulation of air. Never store rope in a small, confined space, without air circulation. Clean thoroughly before storing. Continuous exposure to sunlight is injurious to rope. Improper storage conditions frequently cause so called "dry-rot."

b. Dry rope properly after wetting. Dry rot (chemical deterioration) generally occurs when rope saturated with water is not thoroughly dried in the open air before being put in storage. Rope is dried best when it is hung loosely between two trees, or other objects, so that it does not come in contact with the ground.

c. Keep rope clean. If rope is dirty, it should be washed in clean water and thoroughly dried. Grit from sand, mud, or other matter, if allowed to remain and work into rope, will grind and wear the rope fibers.

d. Protect rope from chemicals. Keep rope away from chemicals or their fumes, especially acids or alkalis, because they are injurious to rope fibers. Drying oils, such as linseed oil, and paint will also damage rope. Keep rope out of reach of animals, for contamination by animal excreta will result in loss of rope strength.

e. Slack off guys. When ropes are used as guy lines or as other supports exposed to weather, slack them off to prevent overstrain because of shortening from wetting, for all rope will shrink when wet.

f. Reverse ends. Reverse rope, end for end, periodically, so that all sections of the rope will receive equal wear. When rope wear is localized in a short section, periodical shortenings will present a new wearing surface.

g. Splice rope. If a rope becomes damaged, cut and splice. A good splice is safer than a damaged section. For the methods of splicing, see TM 5-225, "Rigging and Engineer Hand Tools."

h. Whip ends of rope to prevent unraveling. See TM 5-225, "Rigging and Engineer Hand Tools."

i. Use largest ropes permissible and convenient. The limit of safety on an undersized rope and on one made from poor material is quickly reached. Therefore the safety and length of life of the larger rope more than offsets any difference in the first cost.

77. KNOTS. The ability to tie a few knots will greatly simplify the work involved in erecting and taking down a tent. For information on knots see TM 5-225, "Rigging and Engineer Hand Tools."

CHAPTER 8

PINS, TENT

78. GENERAL. Metal pins are made from a good grade of steel rod or wire, and are strong enough to stand the strain of being forced into frozen ground or ice by means of force applied through the eye. These metal pins are now an item of issue with the two-man mountain tent and with other tents for Arctic use. All wooden pins currently issued receive a wood preservative treatment. In determining the serviceability of pins, look for cracks, splits, distorted ends, and broken or flattened points.



PIN, TENT, SHELTER, WOOD, 9-INCH



PIN, TENT, METAL (NEW-TYPE) 10-8 16-INCH

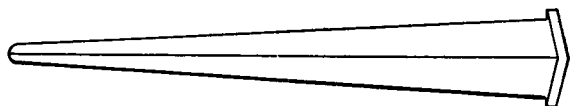

PIN, TENT, MOUNTAIN, TWO-MAN (METAL)
(OLD - TYPE) 12-INCH



PIN, TENT, 16-INCH



PIN, TENT, 24-INCH



PIN, TENT, 36-INCH

Figure 16. Tent pins.

79. DRIVING PINS Short tent pins are driven vertically into the ground. Long tent pins are driven into the ground at a 60° angle, with the top of the pin leaning toward the tent. All pins are driven with their notches away from the tent. (See fig. 47.) Long pins should not be driven vertically or away from the tent because of the natural contraction

of canvas and ropes when exposed to dampness or rain. Such contraction causes high tension which may become strong enough to tear canvas or break ropes and pins. With the tent properly staked, the pin will pull out of the ground and damage will be avoided. An exception to this rule is the assembly tent. The long pins of this tent are driven vertically into the ground. (See par. 43b (2).) It is not safe to allow the pins of



Figure 47. Driving tent pins.

such a large tent to pull out of the ground due to the damage which would be caused if the tent collapsed. The danger of tearing canvas or breaking pins and lines is avoided by loosening the lines from within the tent, thus relieving the tension on the pins. To do this the tent is lowered or raised by adjusting the drift lines which are attached to the block and tackle assemblies on each main pole,

CHAPTER 9

POLES, TENT

80. GENERAL. a. Each pole is stamped to show the kind of pole it represents. *Example:* "Upright lower section, for 12 ft. 0 in. pole." This marking is very important and should be taken note of in all cases, in order to make sure that each tent has its proper poles. When determining whether poles are serviceable, be sure to look for cracks, splits, serviceability of metal joiner, and missing or bent spindles.

b. Upright poles have a tendency to settle down into soft ground. This settling, which loosens the whole tent, may be avoided by placing blocks of wood or flat rocks underneath the bases of the poles.

c. When erecting tent poles, generally sink them from 2 to 4 inches into the ground.



Figure 48. An upright tent pole.



Figure 49. A ridge tent pole.

CHAPTER 10

MISCELLANEOUS INFORMATION

81. TENT FLIES. Flies may be used with the following tents: tent, wall, large; tent, wall, small; tent, storage; tent, squad, M-1942; and tent, hospital ward. Flies are no longer issued for use with the tent, storage; tent, wall, small; tent, wall, large; and tent, squad, M-1942. For information on issue of fly with tent, hospital ward, and fly, tent, wall, large as a separate item, see paragraphs 37g and 15g. A fly is an auxiliary canvas roof used with a tent to shed rain and to make the tent cooler. Most tent flies are set tightly on top of the regular ridge pole. When the tent is not to be moved for a while, it is a better plan to use two ridge poles to make a space between the fly and the ridge of the tent proper for the circulation of air. Flies are usually guyed to the same double-notched tent pins to which the guy lines of the tent proper are attached, and are therefore set rather close to the roof of the tent. The fly may be erected so that it projects in the form of a porch and sits well away from the ridge of the tent. Any fly used with a tent is a good wind trap. For this reason a waterproof tent without a fly is often preferable. The fly may be erected as a completely separate unit for use as a protection for supplies and equipment or as a protection for cooking operations. The fly for the large wall tent is most often employed thus in the Army. Therefore it is issued as a separate item to most units. (See par. 15g.)

82. SOD CLOTHS. (See fig. 50.) The sod cloth is a strip of canvas about 8 or 9 inches wide sewed all along the bottom edge of the tent walls, both sides and ends. When the tent has been set-up, see that the sod cloth lies flat upon the ground inside the tent, and is weighted down with any locally available, clean, dry material. Its function is to keep out insects and crawling animals, as well as the wind and cold. Banking a tent

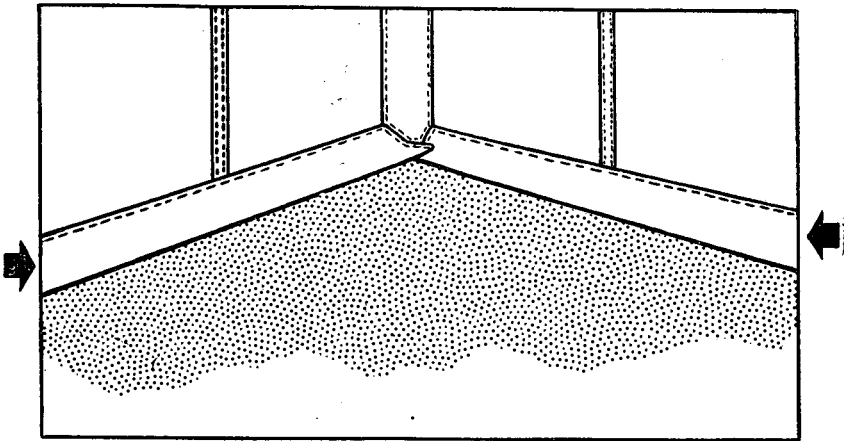

Figure 50. The sod cloth.

inside with leaves and earth is a poor substitute for a sod cloth. The earth and leaves will not stay tight against the tent and the earth will rot the canvas.

83. GROUND CLOTHS. a. Ground cloths are not generally issued for use with Army tentage. Because the ground is soon trodden down hard so that it is easy to sweep and keep clean, it is more sanitary as a floor than ground cloths which get filthy and are very hard to keep clean.

b. The two-man mountain tent has a built-in cloth floor as part of the unit. This is desirable because the tent is used in extremely cold climates and the built-in ground cloths keep out cold wind and drifting snow. The maintenance shelter tent comes equipped with six ground cloths which form a floor. Tanks are repaired in this tent and it is advisable to have the ground cloth so that the spare parts and tools can be laid down on it rather than on the ground.

84. TENT FLOORS. Any tent may have a wooden floor, but floors are used most frequently with wall and pyramidal tents pitched at semi-permanent camps. When flooring is used, it is usually unnecessary to dig a ditch around the tent. It is very important that the floor should be the exact size of the tent. If it is too large, it will pull the tent out of shape. When the floor is fitted snugly, the water runs off instead of running in on the flooring. Even materials which have been waterproofed will shrink slightly after a hard rain, and the tent will, as a result, be a few inches smaller than its specified dimensions. For this reason, if the tent is new, it should be wet thoroughly and then dried before its exact measurement is taken for the construction of the floor.

85. VENTILATION. It is extremely important that a tent be properly ventilated. When a tent is closed up, it is less permeable to air than a house with the windows closed. All Army tents have ventilating facilities provided. Some have built-in ventilators of various types. Stovepipe openings may be used for additional ventilation when the stove is not in use. In hot weather, the doors may be opened, and on most tents the side walls may be rolled up, to give a free circulation of air. The command post tent has four windows for ventilation purposes. The air coming in around the bottom of the tent should never be depended upon for ventilation. If the sod cloth is properly weighted down, very little air should be allowed to enter. The bottom edge of a tent is the least desirable place from which to get ventilation. It is like trying to ventilate a house through the cracks in the floor.

APPENDIX

GLOSSARY

BAIL RING. That part of an assembly tent through which the lifting block and tackle is rigged to the main center poles and to which the various sections of canvas are lashed. Bail rings are made of steel and come in various sizes depending on the sizes of the tents with which they are used.

BEESWAX. A yellow fatty solid substance (residue after honey is extracted from the honeycomb) which becomes pliable when worked. It is applied to cord or thread to strengthen, waterproof, and preserve it.

BIGHT. A loop, or double part, of a tent rope.

CHAIN AND PLATE ASSEMBLY. An assembled piece of tent hardware consisting of a circular metal plate with a hole in the center and four equally spaced holes around the edge to which four chains are attached by "S" hooks. Either a large end hook, "Old Style," or a small end hook, "New Style," holds the chains to the triangles. These triangles, in turn, are secured to the ventilator square at the top of the tent. This assembly fits onto the spindle of a center pole supporting the tent and can be used in any type of push-pole tent.

CHAPE. Any loop of leather or metal.

CONTRINE. The depression between the strands on the outside of a rope.

CORNER STRAP (WEBBING). A strap which secures the "D" ring or a triangle to the corner of a tent.

CUT SPLICE. A loop spliced in the center of guy lines to fit over spindle of pole which supports the top of a tent. This loop eye is generally reinforced with leather.

DOOR FASTENERS. Short lines made of twisted cotton line or braided sash cord. They are used to fasten together the overlapping door flaps to close the door, or they may be used to hold the door flap open.

DOOR FLAP. That part of the tent which forms the covering to the entrance.

EAVE. An extension of the edge of the roof beyond the wall of the tent.

EAVE LINE. The supporting line that extends from the eave of a tent to the pin that is driven into the ground.

END HOOK (S-SHAPED), M-23, PYRAMIDAL. The link that connects the chain and plate assembly to the triangle at the top of the tent.

END WALL. Either end of the storage and wall tents extending from ridge to ground line.

EXTENSION CLOTH. A canvas strip added to one end of the roof on an assembly, command post, large wall, or storage tent. It is used to prevent leakage between units when two or more tents, or sections of the same tent, are put together as one. The extension cloth overlaps the tent or section of tent next to it.

EYE. A spliced loop on the ends of corner and eave lines.

FERRULE. A ring or cap, usually made of metal, put around a pole or similar object to strengthen it, or to prevent splitting and wearing. It is generally employed on pole tops where the spindle is inserted. It is also used to reinforce the heads of heavy tent poles or pins.

FID. A tapered wooden tool, slightly dished at the center. It is used for spreading rope strands when splicing and for rounding out hand-worked holes.

FOOT STOP. A rope loop at the bottom of a side wall. This loop, fitted over a pin driven into the ground, secures the side wall.

GROMMET. A metal eyelet consisting of two parts, grommet barrel and washer, clamped securely on each side of the material, forming a ring. These are used for attaching tie lines, eave lines, and supporting lines. They can be of two styles: sheet grommet, the barrel of which can be used either with a plain, flat sheet washer or a toothed washer; and spur grommet, made, according to size, of a heavy-gauge metal with a rolled rim. These are made with teeth attached.

GROMMET SETTING DIE. A cylindrical metal base formed to receive a grommet, with a similarly formed punch to receive the grommet washer. This is a male and female die that clinches the grommet and washer together, making them one metal ring secured in canvas or similar material.

GUY LINE. A line used to hold the larger tent poles steady.

HOOD. A triangular-shaped piece of canvas used to close the ventilator openings of hospital ward and pyramidal tents.

HOSPITAL WARD VENTILATOR RING. A 1/2-inch galvanized steel ring 10 inches in diameter, without loops, with chain and plate assembly forming bail ring for push pole.

JUMPER LINE. That part of a tent assembly which is fastened to the top and used to lash the top to the upright poles. Its purpose is to keep the canvas from jumping off the spindle of the upright, especially during stormy weather.

LACING LINE (CORNER). The line used to lace the side walls of a tent together at the corners.

LANYARD. Any length of rope, regardless of size, hand-whipped on one end and reinforced by means of spliced eye and thimble. It is used to make various lashings.

LUG. A piece of canvas which is doubled over with the edges folded under, and stitched to the tent to hold ropes or lines. It is usually about 3 inches by 2 inches in size. Such a piece is often sewed next to the doorway of the tent to hold the rope used to secure the door flap when it is open.

OSNABURG. A stout coarse cotton fabric used to wrap up tentage for shipment when no tent cover is provided.

PINS (STAKES). Wooden pegs 16 inches long with one notch, or 24 inches long with two notches, or 36 inches long with no notches. The 36-inch pin is used only with the assembly tent. The 16-inch and 24-inch pins are approximately 2 inches wide and 1 inch thick. Pins are used as anchors for corner, eave, or guy lines or foot stops.

PUNCH FOR GROMMET INSTALLATION. A hollow tubular-shaped metal die, with a sharp edge, used to cut circular holes into which grommets can be inserted.

REINFORCEMENTS. Various shaped patches of canvas, or any piece of canvas, regardless of width or length, used to strengthen seams or joinings where necessary.

RIDGE. The peak of the tent roof that extends between the center poles.

RINGS. These are made of metal, and may be of any size. They are usually used to reinforce all points where supporting lines and poles pass through the tent. They are hand-worked into the canvas with waxed cord or twine.

ROLLER. A cylindrical piece of metal attached to a handle. It is so constructed that the cylinder rotates freely. It is used for smoothing out patches and forcing excess cement from under the patches.

ROPE. A rope is composed of a certain number of strands; each strand is made up of a number of single threads. Three strands, laid or twisted together, form a "hawser-laid" rope, and three such hawsers similarly make a "cable-laid" rope or cable. A "shroud-laid" rope usually consists of four strands laid around a central strand or core. The prepared fiber is twisted or spun to the right to form a yarn; the required number of yarns receive a left-hand twist to make a strand; three strands twisted to the right make a hawser; and three hawsers twisted to the left form a cable. Thus, the twist in each operation is in a different direction from that of the preceding one, and this alteration of direction serves, to some extent, to keep the rope in its proper form and to develop greater tensile strength.

a. The following are various types of ropes:

(1) *Cable.* Three hawsers twisted together.

- (2) *Cord*. Several threads twisted together.
- (3) *Hawser*. A rope of three strands. They are laid up left-handed to form a cable.
- (4) *Rope*. Several strands twisted together.
- (5) *Shroud-laid*. A rope of four strands.
- (6) *Strand*. Two or more large yarns twisted together. They are laid up right-handed to form a rope.
- (7) *String*. The same as thread, but a little larger yarns.
- (8) *Thread*. Two or more small yarns twisted together.
- (9) *Yarn*. Fibers twisted together. They are laid up left-handed to form a strand.

b. Terms describing operations or conditions of rope:

- (1) *Haul*. To pull on a rope.
- (2) *Laid*. Strands twisted together.
- (3) *Paired*. Painted, tarred, or greased to resist wet.
- (4) *Parceled*. Wrapped with canvas.
- (5) *Seized*. Two parts bound together by a yarn, thread, or string.
- (6) *Served*. Covered by a yarn continuously and tightly wound around it.
- (7) *Spliced*. Joined to another rope or a part of the same rope by interweaving of the strands.
- (8) *Taut*. Drawn tight or strained.
- (9) *Whipped*. The ends bound to prevent unraveling. On small lines such as soft twisted cotton lines or braided sash cloth, whipping is usually accomplished with light thread by means of a sewing machine. On heavy ropes (sisal or manila), where more permanent fastening is necessary, this operation is accomplished by means of a waxed twine, sailmaker's needle and palm.

SAIL NEEDLE. These vary in length from $1\frac{3}{4}$ inches to 5 inches. A large number designates a small-sized needle, and a small number a large-sized needle. The needle is composed of three parts: the eye, the shank, and the square. These needles are used by hand workers in many operations of tentmaking. When hand working holes or hand roping, the needles are forced through the canvas by the use of the sailmaker's palm.

SAILMAKER'S PALM. A tool made of leather. The palm is made of hardened pigskin, built up on the under side with enough thicknesses of softer leathers to form a pad for the palm of the hand. A leather band is attached to the pigskin and shaped around the back of the hand and around the thumb. That section of the palm around the thumb is called the nozzle. The plate or thimble of the palm is pressed on the face of the pigskin and surrounded by a sewed piece of pigskin at the main body of the palm surface. It is used when roping large and small tents, when reinforcing the seams and edges, when sewing on patches in the field, and when working in rings by hand.

SHEAVE. A grooved wheel or pulley.

"S" HOOK. This is the link connecting the chain to the plate in the chain and plate assembly. It is made of $\frac{1}{4}$ -inch diameter galvanized iron, shaped as an "S," $1\frac{7}{8}$ inches in length.

SIDE WALL. That part of the tent extending from below the eave to the ground on all sides of the tent. It may be either part of or separate from the top, depending upon the design of the tent.

SLIP. A device 4 inches long, made of steel wire $\frac{3}{16}$ inch in diameter, one end twisted like a coil spring and the other end looped to form an eye. These are used to adjust the eave or guy lines on all tents that have an upright pole not longer than 6 feet.

SOD CLOTH. A canvas strip cut with the warp of the goods and sewed into the hem at the bottom of the walls of all tents. It acts as a ground flap, helping to keep the tent warm in winter and also preventing rain from splashing into the tent.

TENT TOP. Any part of the tent supported by poles, above the side-wall line.

THIMBLE. A metal insert, generally eggshaped and ranging in size from $1\frac{1}{4}$ inches to 4 inches, which fits into a spliced eye. These are used to reinforce the ends of ropes, lanyards, tie lines, etc.

TRIANGLE. A triangular-shaped piece of metal of $\frac{1}{4}$ inch diameter stock with a galvanized finish. It has a base 2 inches wide. It is used as a connecting link between the ventilator square and the chain and plate assembly supporting the tent at the top. It is also used for corner line connections.

TWINE. A string composed of two or more strands, known as folds, which are twisted together loosely, one or more parts of which, when covered with beeswax and twisted are used for hand-sewing.

VENTILATOR PLATE. A plate with a center hole and four corner holes for the ventilator chains. This is used with the ventilators on pyramidal and hospital ward tents.

WALL LINE. A piece of webbing approximately 29 inches in length sewed into the seam of a tent, with half of the line inside and half outside the tent. This line is used to tie up the side wall.

INDEX

	<i>Paragraphs</i>	<i>Pages</i>
Bail ring	App.	69
Chain and plate assemblies	23, 30, 38, App.	25, 28, 34, 69
Extension cloths	App.	70
Ferrules	App.	70
Fire extinguishers	66	55
Flies	15, 37, 81	16, 34, 67
Grommets	App.	70
Ground cloths	83	68
Heating individual shelters	73	61
Hoods	74, App.	61, 70
Knots	77	63
Lines	75, 76	62
Door fasteners	App.	69
Eave	App.	69
Guy	App.	70
Jumper	App.	70
Lacing	App.	70
Wall	App.	73
Patches	69	58
Pins	78, App.	64, 71
Driving	79	64
Poles.		
Ridge	80	66
Upright	80	66
Repair, tent	69	58
Re-treating compound	64	54
Rope	75, 76, App.	62, 71
Shields	74	61
Site, tent	61, 62	51, 52
Sleeves	6	8
Circular	32	31
Slips	App.	73
Sod cloths	82	67
Spark arresters	66, 70	55, 60
Splices	76, App.	62, 72
Stovepipe openings	71	60
Stove, tent, M-1941	72	60
Tents.		
Assembly	41-45	37
Command post	31-35	29
Hammock, jungle	8, 11	9, 12
Hospital ward	40	33
Maintenance, shelter	46-50	42
Mountain, two-man	4-7	7
Pyramidal	26-30	26
Screen, latrine	56-60	48
Shelter-half	1-3	1
Squad	21-25	22
Storage	16-17	18
Surgical, truck	51-55	45
Wall, small	12-13	15
Wall, large	14-15	15
Thimbles	App.	73
Trenches, tent	63	52
Ventilation	85	68
Walls.		
End	App.	70
Side	App.	73
Whipping	76, App.	62, 72